



## Control technology

**PILZ**  
THE SPIRIT OF SAFETY

- ▶ Relays: electronic monitoring relays PMD, safety relays PNOZ
- ▶ Configurable safe small controllers PNOZmulti 2
- ▶ PLC controllers and I/O systems PSSUniversal, PSSUniversal 2
- ▶ Automation system PSS 4000
- ▶ Drive technology PMC
- ▶ Operator terminals PMI



Pilz control technology -  
for safety and automation.

# ▶ Control technology

Pilz offers the right control technology solution for every situation. From stand-alone applications to networked and distributed systems – for safety and automation. Meet your automation requirements cost-effectively, reliably and from a single source with optimally matched components and systems. Our software tools enable simple operation and make commissioning easier. Combine that with network components and software and you get complete automation architectures that also take into account industrial security. Benefit from short downtimes and high plant availability due to extensive diagnostic and visualization options. In a globalized industry it is an economic imperative for manufacturing processes to be automated in compliance with safety directives and standards. As the worldwide safety expert, Pilz supports you with innovative products and services.

## Contents

---

<b>Pilz control technology – for safety and automation</b>		<b>PLC controllers and I/O systems</b>	104
	4	▶ Automation system PSS 4000	108
		▶ Firewall SecurityBridge	112
<b>Relays</b>	10	▶ Decentralized I/O system PSSuniversal	114
▶ Electronic monitoring relays PMDsigma	12	▶ Remote I/O system PSSuniversal 2	134
▶ Electronic monitoring relays PMDsrangle	14		
▶ Safety relay PNOZ	18	<b>Drive technology PMC</b>	142
▶ Safety Device Diagnostics	60	▶ Motion control systems PMCprimo	148
		▶ Servo amplifier PMCprotego	158
<b>Configurable safe small controllers</b>	64	▶ Servo motors PMCtendo SZ	166
▶ Configurable safe small controllers PNOZmulti 2	66	<b>Operator terminals PMI</b>	174
▶ Software tools PNOZmulti Configurator, diagnostic solution PVIS	96	▶ Visualization panels PMIvisu	176
▶ Accessories PNOZmulti	98	▶ Control panels PMIcontrol	177
		▶ Motion control panels PMIprimo	177
<b>Decentralized modules PDP67</b>	100	▶ Visualization software PASvisu	182
▶ Cable navigator	102	<b>Services</b>	184
		<b>Index</b>	186

# ► Pilz control technology – for safety and automation

## Relays

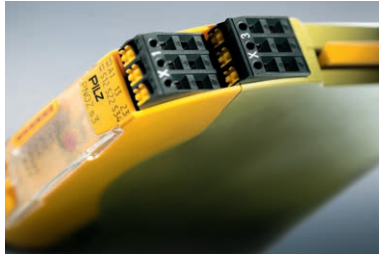

### Easy to configure!

- Reliability of one of the leading brands in automation technology
- Optimum cost/performance ratio
- Maximum safety with minimum space requirement
- Certified safety, because international standards and regulations are met
- Fast commissioning thanks to units with plug-in connection terminals

Page 10  
Webcode: web150079

## Small controllers PNOZmulti



### Configuration made simple!

- Cost-effective and long-lasting: worldwide safety standard for many automation environments and communication systems
- Flexible: configuration using certified software blocks, simple adjustment and adaptation
- Just one system from planning to maintenance
- Exact adaptation to the application using expansion modules
- Optimum visualization using the web-based visualization software PASvisu

Page 64  
Webcode: web150495

## PLC controllers



### Simple programming of large plants!

- Processing of safety and automation functions
- Can be used as a stand-alone controller or as part of a network
- Intuitive programming of complex functions
- High level of flexibility thanks to modular system structure
- Extensive selection of modules to meet your specific requirements

Page 108  
Webcode: web150509

**I/O systems**



**System for third-party controllers**

- ▶ Communication with the controller takes place via common fieldbus protocols
- ▶ Functions for safety and automation are processed decentrally at field level
- ▶ Fast commissioning and easy configuration thanks to the independent periphery test
- ▶ High level of flexibility thanks to modular system structure

PSSuniversal: Page 114  
Webcode: web150509

PSSuniversal 2: Page 134  
Webcode: web150509

**Drive technology PMC**



**Safe and efficient automation!**

- ▶ Maximum safety up to PL e in accordance with EN ISO 13849-1
- ▶ Highly flexible due to various fieldbus systems, feedback systems and functionalities
- ▶ Fast to commission and simple to service thanks to universal programming in accordance with EN/IEC 61131-3
- ▶ High energy savings thanks to efficient servo technology
- ▶ Cost-optimized by means of a safe motion concept, customized machine operating concept and energy consulting

Page 142  
Webcode: web150506

**Operator terminals PMI**



**Modern HMIs for visualization and control**

- ▶ Reduced downtimes and increased cost effectiveness of your system
- ▶ Flexible, complete solution for visualization of the automation system PSS 4000 and small controller PNOZmulti
- ▶ Wide range of application options due to numerous display sizes and feature options
- ▶ Sophisticated diagnostic and visualization concept with the software PASvisu and PVIS
- ▶ Quality "Made in Germany"

PMI: Page 176  
Webcode: web150778

PASvisu: Page 182  
Webcode: web150430

# ► The right control technology for your requirements!

Pilz is a technology leader and full-service provider in safe control technology. Our safety controllers are used around the world and have proven themselves over decades. Trust in our expertise in machinery safety: We have the right solution for all your needs! Always in focus: The safe shutdown of hazardous movements and the smooth control of your machinery.

Safety is our core competency, which is why our claim is to automate plant and machinery such that the safety of human, machine and the environment is always guaranteed.

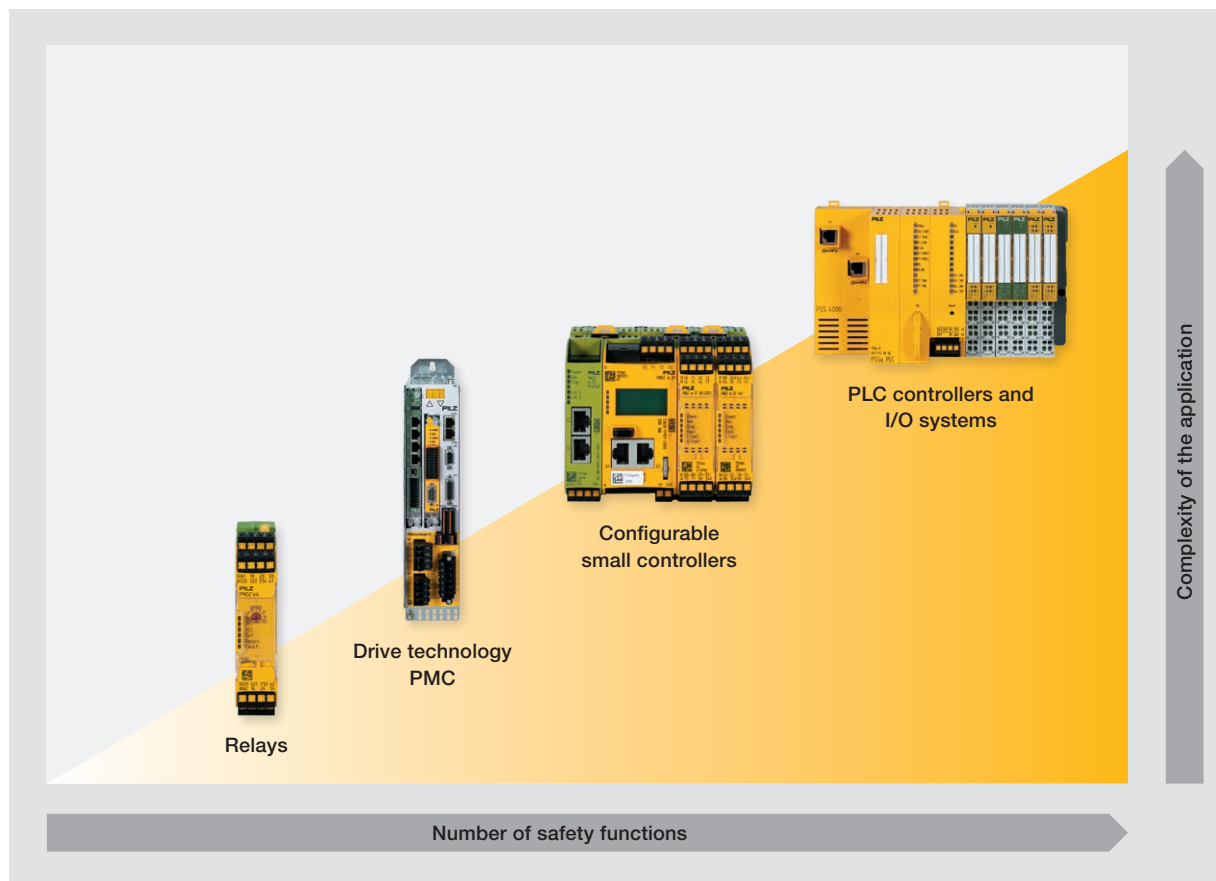

**Advantages of safe control technology from Pilz**

- ▶ Processing of safety and automation functions
- ▶ Monitoring of all common safety functions
- ▶ High plant availability, protection of your employees, increase of cost effectiveness
- ▶ Protection of your employees through safety up to Performance Level e of EN ISO 13849-1 and SIL CL 3 of EN/IEC 62061
- ▶ Optimum automation solutions for your requirement
- ▶ Simplicity, convenient operation and intuitive configuration
- ▶ Flexibility and modular expandability – our solutions grow with your plant
- ▶ Proven Pilz technology with quality that you can rely on

	Relays	Configurable small controllers	PLC controllers and I/O systems	Controller PMCprimo	Safety card PMCprotego S
<b>Safety functions</b> Emergency stop, light curtains, safety gates and much more	◆	◆	◆		
<b>Project creation/engineering tool</b> ▶ Graphic configuration ▶ Programming in accordance with EN/IEC 61131-3		◆	◆ ◆	◆ ◆	◆
<b>Motion monitoring</b> ▶ Standstill, speed ▶ Complex functions	◆	◆ ◆	◆ ◆	◆	◆
<b>Networking</b> ▶ Ethernet ▶ Fieldbuses		◆ ◆	◆ ◆	◆ ◆	◆ ◆
<b>Diagnostics and visualization</b> ▶ Hardware diagnostics/LED ▶ PASvisu visualization	◆	◆ ◆	◆ ◆	◆	◆
<b>Automation functions</b> PID controllers, counter monitoring, speed recognition and detection and much more			◆	◆	

Relays

Configurable safe small controllers

PLC controllers and I/O systems

Drive technology PMC

Operator terminals PMI

## ► Functional safety – for protection of humans, the

It pays to use functional safety technology: The protection of humans, the environment and machinery through the targeted control of hazardous movements, cost savings thanks to fewer accidents, reduced downtimes and fewer production losses – these are real benefits that you can enjoy when you use safe control technology from Pilz. Your automated plants are safer with control technology from Pilz! The result: Satisfied, healthy employees and maximum availability of the your plant and machinery for maximum business success.

### Control technology from Pilz – certified worldwide

When using safe control technology from Pilz, the aim is to keep the risk to human and machine as low as possible. Internationally co-ordinated standards have been introduced to ensure that the same level of protection can be guaranteed in all countries. Our products have been tested and approved by renowned certification bodies according to current directives, standards and regulations. Long service life and high availability ensure it is cost-effective to use. Pilz is happy to accompany you on your path to enhanced safety with a wide range of services throughout the plant and machinery lifecycle.

### Protective measures for machines and systems

Risk assessment plays a central role here with regard to the requirements for functional safety. The steps that you must follow during risk assessment and risk reduction on machinery and how the safety functions can be evaluated and verified are taken from the standards EN ISO 12100, 13849-1/-2 and EN/IEC 62061. The risk assessment results in the requirements for safety integrity (PL, SIL).

You can find services from Pilz on page 184 or:

Webcode:  
web7792

Online information at [www.pilz.com](http://www.pilz.com)

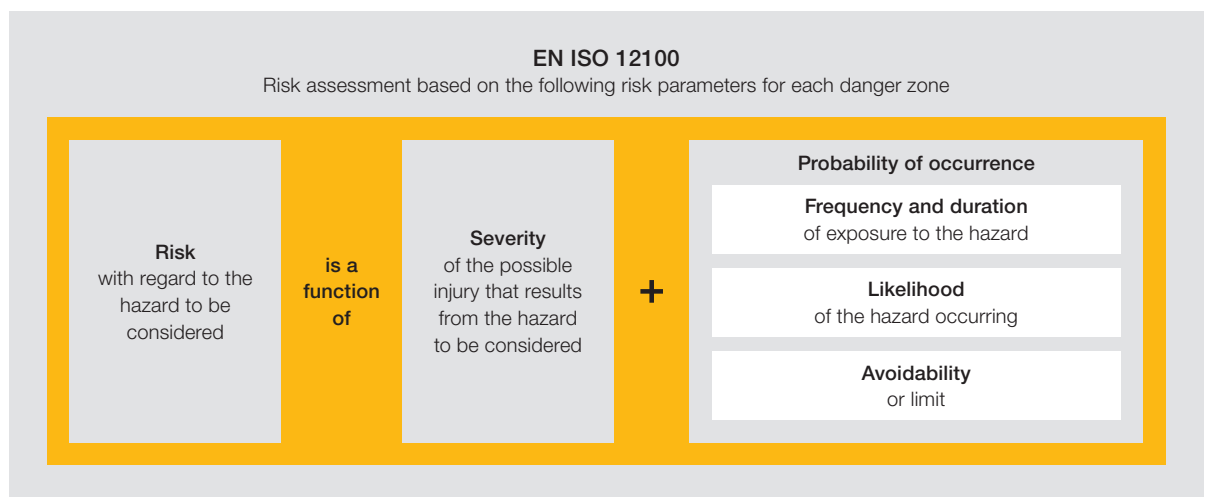

This standard harmonized under the Machinery Directive specifies fundamental concepts, terminology and principles for design that are applicable for all machinery categories.



# environment and machinery

## EN ISO 13849-1

This standard is applicable for electrical/electronic/programmable electronic/hydraulic/pneumatic/mechanical systems. The greater the risk, the higher the requirements of the control systems. The hazardous situation is classified in five levels, so-called Performance Levels (PL), from PL "a" (low) to PL "e" (high). The required PL is determined or assigned as part of the risk assessment in accordance with EN ISO 13849-1.

## EN/IEC 62061

EN/IEC 62061 represents a sector-specific standard under IEC 61508. It describes the implementation of safety-related electrical control systems on machinery and examines the overall lifecycle from the concept phase through to decommissioning. In contrast to EN/IEC 61508, EN/IEC 62061 was published as a harmonized standard under the Machinery Directive in the Official Journal of the EU. As such, presumption of conformity applies for this standard.

### Determination of the required Performance Level (PL<sub>r</sub>) in accordance with EN ISO 13849-1

- ▶ **S – Severity of injury**  
 S<sub>1</sub> = Slight (normally reversible injury)  
 S<sub>2</sub> = Serious (normally irreversible injury including death)
- ▶ **F – Frequency and/or duration of exposure to a hazard**  
 F<sub>1</sub> = Seldom to quite often and/or the exposure time is short  
 F<sub>2</sub> = Frequent to continuous and/or the exposure time is long
- ▶ **P – Possibility of avoiding the hazard**  
 P<sub>1</sub> = Possible under specific conditions  
 P<sub>2</sub> = Scarcely possible
- ▶ **Probability of occurrence of a hazardous event**  
 A low probability can reduce the PL<sub>r</sub> by one level.

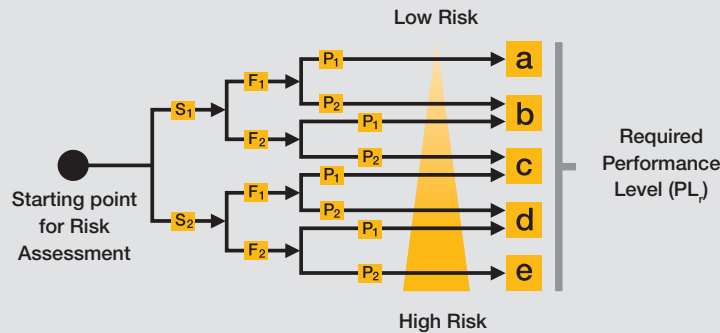

Keep up-to-date on standards:

Webcode: web83082

Online information at [www.pilz.com](http://www.pilz.com)

### Determination of the required Safety Integrity Level (SIL) in accordance with EN/IEC 62061

Frequency and duration	F > 10 min	F ≤ 10 min	Probability of hazardous event	W	Avoidance	P
≤ 1 hour	5	5	Very high	5		
> 1 hour – ≤ 1 day	5	4	Likely	4		
> 1 day – ≤ 2 weeks	4	3	Possible	3	Impossible	5
> 2 weeks – ≤ 1 year	3	2	Rarely	2	Possible	3
> 1 year	2	1	Negligible	1	Likely	1

Consequences and severity	S	Class CI = Fr+Pr+Av				
		3-4	5-7	8-10	11-13	14-15
Death, losing an eye or arm	4	SIL 2	SIL 2	SIL 2	SIL 3	SIL 3
Permanent, losing fingers	3	OM	SIL 1	SIL 2	SIL 3	SIL 3
Reversible, medical treatment	2			OM	SIL 1	SIL 2
Reversible, first aid	1				OM	SIL 1

OM = other measures recommended

# ► Relays

Electrical or functional safety – our relays provide the perfect solution for any application at an optimum cost/performance ratio. Choose one of the leading brands in automation technology – a brand with many years of experience and outstanding service.

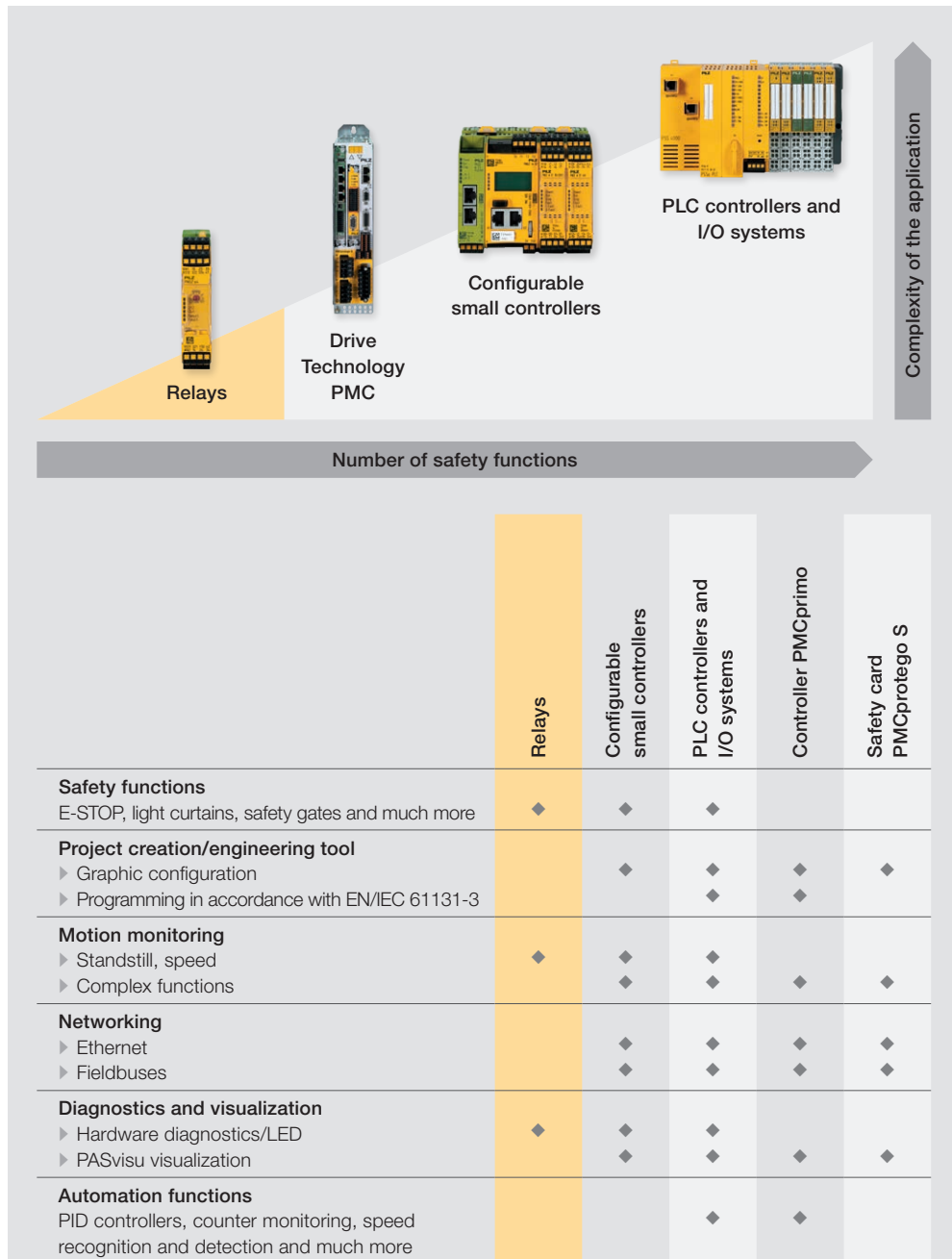

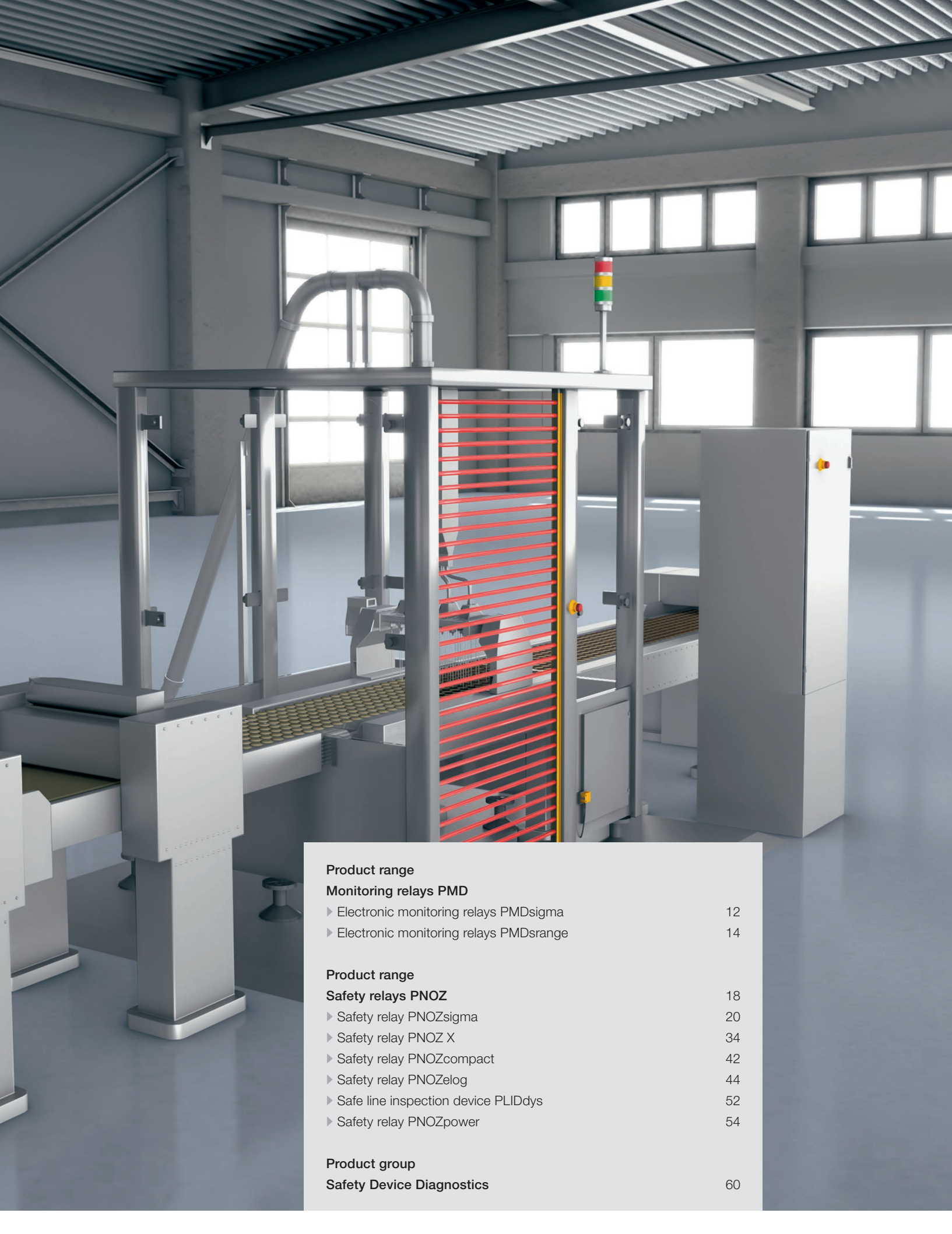

**Product range**

**Monitoring relays PMD**

- ▶ Electronic monitoring relays PMDsigma 12
- ▶ Electronic monitoring relays PMDsigma 14

**Product range**

**Safety relays PNOZ**

- ▶ Safety relay PNOZsigma 18
- ▶ Safety relay PNOZsigma 20
- ▶ Safety relay PNOZ X 34
- ▶ Safety relay PNOZcompact 42
- ▶ Safety relay PNOZelog 44
- ▶ Safe line inspection device PLIDDys 52
- ▶ Safety relay PNOZpower 54

**Product group**

- Safety Device Diagnostics 60**

## ▶ Electronic monitoring relays PMDsigma

With electronic monitoring relays, the focus is on electrical safety. Monitoring relays reduce the number of hazardous situations for man and machine and increase the service life of plant and machinery. Save costs and be sure of an efficient production cycle.



PMD s10

### Applications PMD s10

Using the measured true power, it is possible to derive variables such as fill level, volume, torque or air pressure. The following example applications illustrate potential areas of use:

- ▶ Contamination of sieves or filters on ventilation systems
- ▶ To check for dry running or pump blockage
- ▶ Viscosity of fluids on mixers
- ▶ Wear and tear on tools
- ▶ To control the brush pressure on car washes
- ▶ To monitor conveyors for blockages or wear and tear



### Technical details – Electronic monitoring relays PMDsigma



PMD s20

Type	Application area	Features
PMD s10	Monitoring and conversion of true power for single/three-phase AC/DC supplies, monitoring of overload and underload. Suitable for use with frequency-controlled motors and current transformers.	<ul style="list-style-type: none"> <li>▶ Menu-driven stepless adjustment of function parameters via display and rotary knob</li> <li>▶ Display for measurements, diagnostics and menu navigation</li> <li>▶ Measuring range is set automatically for current and voltage</li> </ul>
PMD s20	Monitors the insulation resistance of unearthed AC/DC power supplies (IT networks), e.g. on ships, in areas used for medical applications, as a trigger when impermissible insulation resistances occur. Meets the requirements of DIN EN 61557-8, IEC 60364-7-710 and DIN VDE 0100-710.	<ul style="list-style-type: none"> <li>▶ Response value <math>R_{on}</math>: selectable from 10 ... 200 kΩ</li> <li>▶ Rated mains voltage: 0 ... 400 VAC/DC</li> <li>▶ Rated mains voltage <math>U_L</math>: 0 ... 300 VAC/DC</li> </ul>

**Applications PMD s20**

The PMD s20 can be used to monitor the insulation resistance of unearthed AC/DC systems. Thanks to the separate supply voltage, monitoring of the de-energized system is possible. Typical application areas include:

- ▶ Clinical operating theatres
- ▶ Offshore installations such as wind turbines, sewage treatment plants and shiplifts
- ▶ Electroplating and surface finishing systems

**Your benefits at a glance**

- ▶ Quick and easy settings using the rotary knob (push and turn) to reduce set-up and commissioning times
- ▶ Error-proof: menu-guided configuration with device-internal cross-comparison
- ▶ Simple handling when replacing devices thanks to exchangeable program memory for porting data
- ▶ Minimal downtimes thanks to extended diagnostics and measurement indication via display



	Certification	Order number
<ul style="list-style-type: none"> <li>▶ Analog output for current and voltage: Voltage output 0 ... 10 V, current output convertible from 0 ... 20 mA to 4 ... 20 mA</li> <li>▶ 2 relay outputs (auxiliary contacts (C/O)) for monitoring underload and overload</li> <li>▶ Measuring voltage (3 AC), <math>U_M</math> (AC/DC): 100 ... 550 V</li> <li>▶ Measuring current (<math>I_M</math>): 1 ... 12 A AC/DC</li> <li>▶ Dimensions (H x W x D) in mm: 100/98<sup>1)</sup> x 45 x 120</li> </ul>	CE, cULus Listed	<ul style="list-style-type: none"> <li>▶ Spring-loaded terminals PMD s10 C _____ 761 100</li> <li>▶ Plug-in screw terminals PMD s10 _____ 760 100</li> </ul>
<ul style="list-style-type: none"> <li>▶ Supply voltage <math>U_B</math> AC/DC: 24 ... 240 VAC/DC</li> <li>▶ Frequency range AC: 50 ... 60 Hz</li> <li>▶ Start suppression/reaction time: selectable from 0 ... 30 s</li> <li>▶ Hysteresis: selectable from 0 ... 50 %</li> <li>▶ Dimensions (H x W x D) in mm: 100/98<sup>1)</sup> x 45 x 120</li> </ul>	CE, cULus Listed	<ul style="list-style-type: none"> <li>▶ Spring-loaded terminals PMD s20 C _____ 761 120</li> <li>▶ Plug-in screw terminals PMD s20 _____ 760 120</li> </ul>

Keep up-to-date on PMDsigma:

 Webcode: web150376

Online information at [www.pilz.com](http://www.pilz.com)

<sup>1)</sup> Height incl. spring-loaded terminals/plug-in screw terminals

## ▶ Electronic monitoring relays PMDsrange

With monitoring relays, the focus is on the protection of persons and machinery against insulation faults, residual voltages, overvoltage, overcurrent, overload, temperature overload as well as monitoring standstill and true power. Significantly reduce hazardous situations for human and machine, while at the same time increasing the service life of your plant.



S3UM



S1IM



S1WP

### Safe monitoring of every situation

Reliable electronic monitoring and control of your plant or machinery is always the priority. Save costs and guarantee an efficient production cycle. Simply by using monitoring relays! You'll find the right device for every monitoring task.

### User-friendly features

PMDsrange units in 22.5 mm slimline housing cover the widest range of functions. Selectable measuring ranges and a high number of operating voltages enable flexible use. Quick and easy installation, practical terminals, a variety of operator elements as well as luminous displays all help to make commissioning easier and ensure the units are perfectly tailored to your specific application.



**Many applications**

You can use the PMDsrangle devices in a multitude of applications: for monitoring the temperature of motors, for monitoring voltage at bottle conveyor systems, to monitor blockages at pumps, and many other applications.

**Your benefits at a glance**

- ▶ Parameters can be set on the front, thereby reducing commissioning times
- ▶ Save space in the control cabinet: widths of just 22.5 mm
- ▶ Rapid diagnostics via LED status display

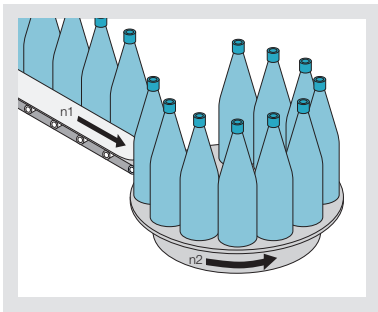
**Bottling plant with voltage monitoring**

Use voltage monitors, for example, to monitor voltage supplies on bottling plants. The monitoring relay ensures that the plant is shut down in a controlled manner. It also protects against an uncontrolled restart.

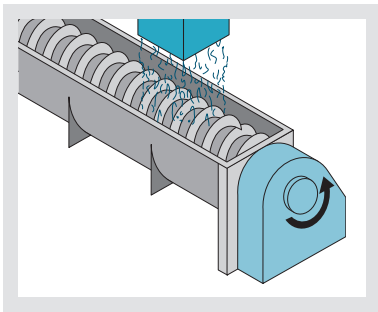
**Screw conveyor with current monitoring**

You need to monitor current, e.g. at a screw conveyor? It can provide protection against blockage and wear and tear, thereby helping with preventive maintenance.

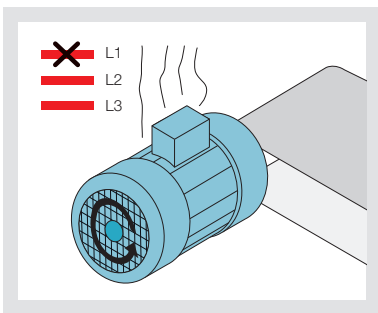
**Motor with thermistor monitoring**

Use thermistor monitoring to protect your motors from overheating. Also prevent automatic start-up. This is particularly important for adverse cooling and where frequent start-up or braking of the motor is required. Thermistor monitoring relays such as S1MS are also available with ATEX approval.

Keep up-to-date on PMDsrangle:

Webcode:  
web150375

Online information at [www.pilz.com](http://www.pilz.com)

## ► Technical details – PMDsrage

### Selection guide – Electronic monitoring relays PMDsrage



S3UM



S1PN



S1IM



S1EN



S1MS

Type	Application area
<b>S3UM</b>	<p>Monitoring of overvoltage and undervoltage as well as the phase sequence in three-phase supplies</p> <ul style="list-style-type: none"> <li>▶ Monitoring of supplies with and without neutral conductors</li> <li>▶ Trip device for undervoltage and overvoltage</li> <li>▶ Phase sequence evaluation</li> <li>▶ Detects asymmetry and phase failure</li> </ul>
<b>S1PN</b>	<p>Monitoring of phase sequence and phase failure on three-phase supplies</p> <ul style="list-style-type: none"> <li>▶ Measuring voltage up to 690 VAC</li> <li>▶ Monitoring of rotary field direction = phase sequence, rotation direction on drives</li> </ul>
<b>S1IM</b>	<p>Monitors AC/DC currents for max. current values, single-phase</p> <ul style="list-style-type: none"> <li>▶ 12 measuring ranges from 0.002 ... 15 A, selectable</li> <li>▶ Reaction time can be set to up to 10 seconds</li> <li>▶ Operates to either normally energized or normally de-energized mode</li> <li>▶ Galvanic isolation between measuring and supply voltage</li> <li>▶ UP version: measuring inputs are not polarity-sensitive</li> </ul>
<b>S1EN</b>	<p>Monitoring of insulation and earth faults on galvanically isolated AC/DC supplies (IT networks), single and three-phase. Meets the requirements of DIN EN 61557-8</p> <ul style="list-style-type: none"> <li>▶ For DC and AC supplies</li> <li>▶ Normally energized mode</li> <li>▶ Fault latching or automatic reset</li> <li>▶ Normal/test mode</li> <li>▶ External reset button can be connected</li> </ul>
<b>S1WP</b>	<p>Monitoring and conversion of true power, DC supplies and single-/three-phase AC supplies, monitoring of overload and underload</p> <ul style="list-style-type: none"> <li>▶ 9 different measuring ranges</li> <li>▶ Large voltage measuring range</li> <li>▶ Analog output can be switched for current and voltage</li> <li>▶ Relay output for monitoring underload and overload</li> <li>▶ Suitable for use with frequency-controlled motors</li> <li>▶ Suitable for current transformers</li> </ul>
<b>S1MS</b>	<p>Temperature monitoring circuits in accordance with DIN EN 44081 to protect motors, generators, storage areas, etc. from overheating</p> <ul style="list-style-type: none"> <li>▶ For DC and AC supplies</li> <li>▶ Normally energized mode</li> <li>▶ Measuring circuit for connecting a temperature sensor (PTC resistor)</li> <li>▶ Automatic reset</li> </ul>

#### Common features

- ▶ Dimensions (H x W x D) in mm: 87 x 22.5 x 121
- ▶ Selectable measuring ranges available in many operating voltages
- ▶ With screw terminals



Technical features	Certification	Order number <sup>1)</sup>
<ul style="list-style-type: none"> <li>▶ Supply voltage (U<sub>B</sub>): AC: 120, 230 V; DC: 24 V</li> <li>▶ Output contact: 1 auxiliary contact (C/O)</li> <li>▶ Measuring voltage (3 AC) (U<sub>M</sub>): AC: 42, 100/110, 230, 400/440, 440/480, 415/460, 500/550 V, selectable</li> </ul>	<ul style="list-style-type: none"> <li>▶ CE, cULus Listed, CCC</li> <li>▶ CE, CCC</li> <li>▶ CE, CCC</li> </ul>	<ul style="list-style-type: none"> <li>▶ 24 VDC (U<sub>B</sub>), 230 VAC (U<sub>M</sub>) _____ 837 260</li> <li>▶ 24 VDC (U<sub>B</sub>), 400/440 VAC (U<sub>M</sub>) _____ 837 270</li> <li>▶ 24 VDC (U<sub>B</sub>), 415/460 VAC (U<sub>M</sub>) _____ 837 280</li> </ul>
<ul style="list-style-type: none"> <li>▶ Supply voltage (U<sub>B</sub>): AC: 200 ... 240, 400 ... 500, 550 ... 690 V</li> <li>▶ Output contacts: 2 auxiliary contacts (2 C/O)</li> </ul>	<ul style="list-style-type: none"> <li>▶ CE, cULus Listed, CCC</li> <li>▶ CE, CCC</li> <li>▶ CE, CCC</li> </ul>	<ul style="list-style-type: none"> <li>▶ 200 ... 240 V _____ 890 200</li> <li>▶ 400 ... 500 V _____ 890 210</li> <li>▶ 550 ... 690 V _____ 890 220</li> </ul>
<ul style="list-style-type: none"> <li>▶ Supply voltage (U<sub>B</sub>): AC: 24, 42 ... 48, 110 ... 127, 230 ... 240 V; DC: 24 V</li> <li>▶ Output contact: 1 auxiliary contact (C/O)</li> </ul>	<ul style="list-style-type: none"> <li>▶ CE, cULus Listed, CCC</li> </ul>	<ul style="list-style-type: none"> <li>▶ 110 ... 130 VAC (U<sub>B</sub>), 15 A (I<sub>M</sub>) _____ 828 040</li> <li>▶ 230 ... 240 VAC (U<sub>B</sub>), 15 A (I<sub>M</sub>) _____ 828 050</li> <li>▶ 24 VDC (U<sub>B</sub>), 15 A (I<sub>M</sub>) _____ 828 035</li> </ul>
<ul style="list-style-type: none"> <li>▶ Supply voltage (U<sub>B</sub>): AC/DC: 24 ... 240 V</li> <li>▶ Output contact: 1 auxiliary contact (C/O)</li> <li>▶ Rated mains voltage (monitored supply): - 50 kΩ version: AC/DC: 0 ... 240 V - 200 kΩ version: AC/DC: 0 ... 400 V</li> <li>▶ Max. measuring current (DC): - 50 kΩ version: 2.4 mA - 200 kΩ version: 1.0 mA</li> </ul>	<ul style="list-style-type: none"> <li>▶ CE, cULus Listed, CCC</li> </ul>	<ul style="list-style-type: none"> <li>▶ 24 ... 240 VAC/DC (U<sub>B</sub>), 50 kΩ _____ 884 100</li> <li>▶ 24 ... 240 VAC/DC (U<sub>B</sub>), 200 kΩ _____ 884 110</li> </ul>
<ul style="list-style-type: none"> <li>▶ Supply voltage (U<sub>B</sub>): DC: 24 V; AC/DC: 230 V</li> <li>▶ Output contact: 1 auxiliary contact (C/O)</li> <li>▶ Measuring voltage: 3 AC/DC: 0 ... 120, 0 ... 240, 0 ... 415, 0 ... 550 V 1 AC/DC: 0 ... 70, 0 ... 140, 0 ... 240, 0 ... 320 V</li> </ul>	<ul style="list-style-type: none"> <li>▶ CE, cULus Listed, UL/cUL, CCC</li> </ul>	<ul style="list-style-type: none"> <li>▶ 24 V DC (U<sub>B</sub>), 0 ... 240 VAC/DC (U<sub>M</sub>), 9 A (I<sub>M</sub>) _____ 890 010</li> <li>▶ 24 V DC (U<sub>B</sub>), 0 ... 415 VAC/DC (U<sub>M</sub>), 9 A (I<sub>M</sub>) _____ 890 020</li> <li>▶ 24 V DC (U<sub>B</sub>), 0 ... 550 VAC/DC (U<sub>M</sub>), 9 A (I<sub>M</sub>) _____ 890 030</li> </ul>
<ul style="list-style-type: none"> <li>▶ Supply voltage (U<sub>B</sub>): AC: 48, 110, 230, 240, 400 V; AC/DC: 24 V</li> <li>▶ Output contacts: 2 auxiliary contacts (2 C/O)</li> </ul>	<ul style="list-style-type: none"> <li>▶ CE, cULus Listed, CCC</li> <li>▶ CE, cULus Listed, CCC</li> <li>▶ CE, CCC</li> </ul>	<ul style="list-style-type: none"> <li>▶ 24 VAC/DC (U<sub>B</sub>) _____ 839 775</li> <li>▶ 230 VAC (U<sub>B</sub>) _____ 839 760</li> <li>▶ 400 VAC (U<sub>B</sub>) _____ 839 770</li> </ul>

<sup>1)</sup> Other versions on request

Order number features: U<sub>B</sub> = Supply voltage;  
U<sub>M</sub> = Measuring voltage; I<sub>M</sub> = Measuring current

Technical documentation for electronic monitoring relays PMDsrangle:

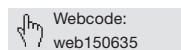

Online information at [www.pilz.com](http://www.pilz.com)

## ▶ Safety relay PNOZ®

In 1987, Pilz patented the first E-STOP relay to protect human and machine. That was a milestone in safety technology. Today, the PNOZ safety relays are proven daily in millions of applications worldwide. In addition to the classic E-STOP function, our safety relays also monitor safety gates, light barriers, two-hand controls, safety mats and many other safety functions.

We can offer the optimum safety solution for each application. Our safety relays are distinguished by a variety of supply voltage ranges, the number of safety contacts, the number of terminals or the ability to plug in terminals. Unit types in push-in technology offer a great advantage

in terms of both economy and safety. They help you to reduce costs through short commissioning and service times. Based on their different features and functionalities, our products can be divided into the following product groups:

	<p><b>PNOZsigma</b></p> <ul style="list-style-type: none"> <li>▶ Maximum functionality in minimum width</li> <li>▶ Operating modes and times are selectable</li> <li>▶ Scalability thanks to modular structure</li> </ul>
	<p><b>PNOZ X</b></p> <ul style="list-style-type: none"> <li>▶ Tailor-made safety for each function</li> <li>▶ Electromechanical, potential-free</li> <li>▶ With universal power supply</li> </ul>
	<p><b>PNOZcompact</b></p> <ul style="list-style-type: none"> <li>▶ Square, simple, yellow</li> <li>▶ Ideal for high volume manufacturers of series machines</li> <li>▶ Basic function of a safety application</li> </ul>
	<p><b>PNOZelog</b></p> <ul style="list-style-type: none"> <li>▶ Easy to link</li> <li>▶ Non-wearing</li> <li>▶ Extended diagnostics</li> </ul>
	<p><b>PNOZpower</b></p> <ul style="list-style-type: none"> <li>▶ High loads from 8 A to 16 A</li> <li>▶ Switch motor loads directly</li> <li>▶ Modular output contacts</li> </ul>

### Finding your PNOZ

This diagram will help you to choose. You have specific requirements, we have the right solution.

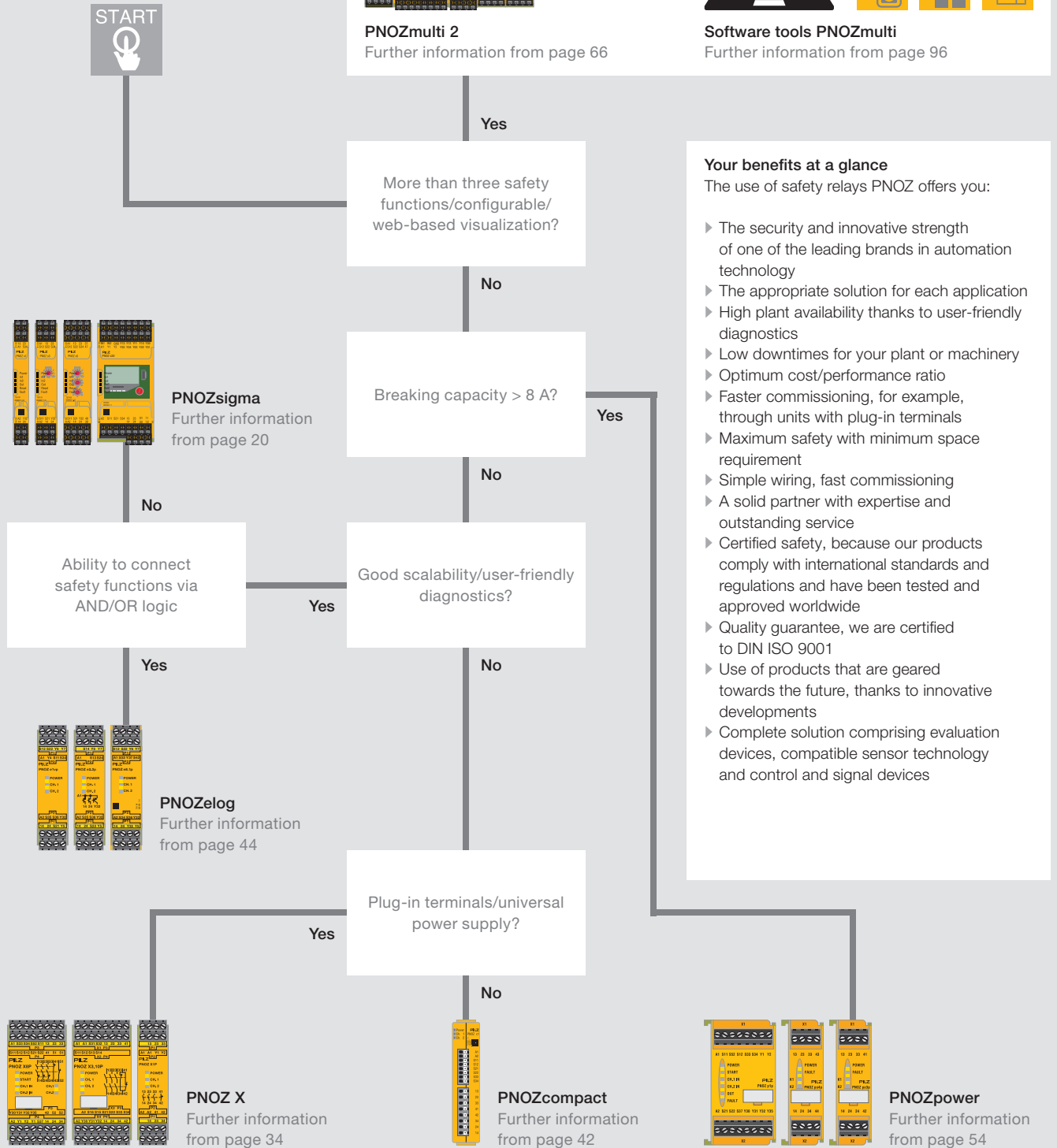

**Your benefits at a glance**  
The use of safety relays PNOZ offers you:

- ▶ The security and innovative strength of one of the leading brands in automation technology
- ▶ The appropriate solution for each application
- ▶ High plant availability thanks to user-friendly diagnostics
- ▶ Low downtimes for your plant or machinery
- ▶ Optimum cost/performance ratio
- ▶ Faster commissioning, for example, through units with plug-in terminals
- ▶ Maximum safety with minimum space requirement
- ▶ Simple wiring, fast commissioning
- ▶ A solid partner with expertise and outstanding service
- ▶ Certified safety, because our products comply with international standards and regulations and have been tested and approved worldwide
- ▶ Quality guarantee, we are certified to DIN ISO 9001
- ▶ Use of products that are geared towards the future, thanks to innovative developments
- ▶ Complete solution comprising evaluation devices, compatible sensor technology and control and signal devices

## ► Safety relays PNOZsigma

The compact safety relays PNOZsigma combine many years of experience with today's very latest safety technology: you can achieve maximum safety and cost-effectiveness with minimum effort. With particularly narrow housing widths and multifunctionality compressed into each unit, PNOZsigma provides maximum functionality in minimum width. So you can implement safety technology faster, with greater flexibility and therefore more efficiently, while saving space.



### Small number of types – suitable for a variety of uses

- Selectable operating modes and times enable each unit to be flexible in its application
- A single unit type monitors different safety functions
- Your stockholding can be reduced to a few unit types

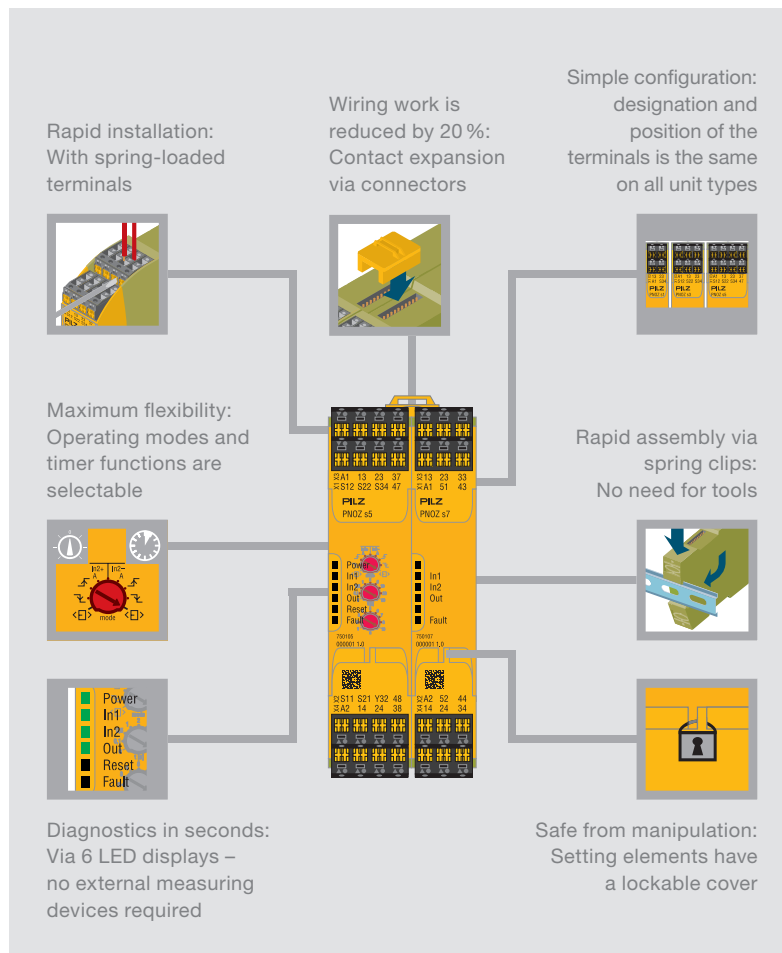

### Your benefits at a glance

- Narrow widths save space within the control cabinet, and therefore costs
- Reduction in wiring costs through push-in technology and contact expansion through the use of connectors
- Rapid commissioning and high availability
- Low logistics costs: Few unit types covering many safety functions
- PNOZsigma are suitable for use at altitudes up to 5 000 meters
- Opt for the complete solution from Pilz and use PNOZsigma with compatible safety components such as E-STOP pushbuttons or safe sensors such as safety switches and light curtains

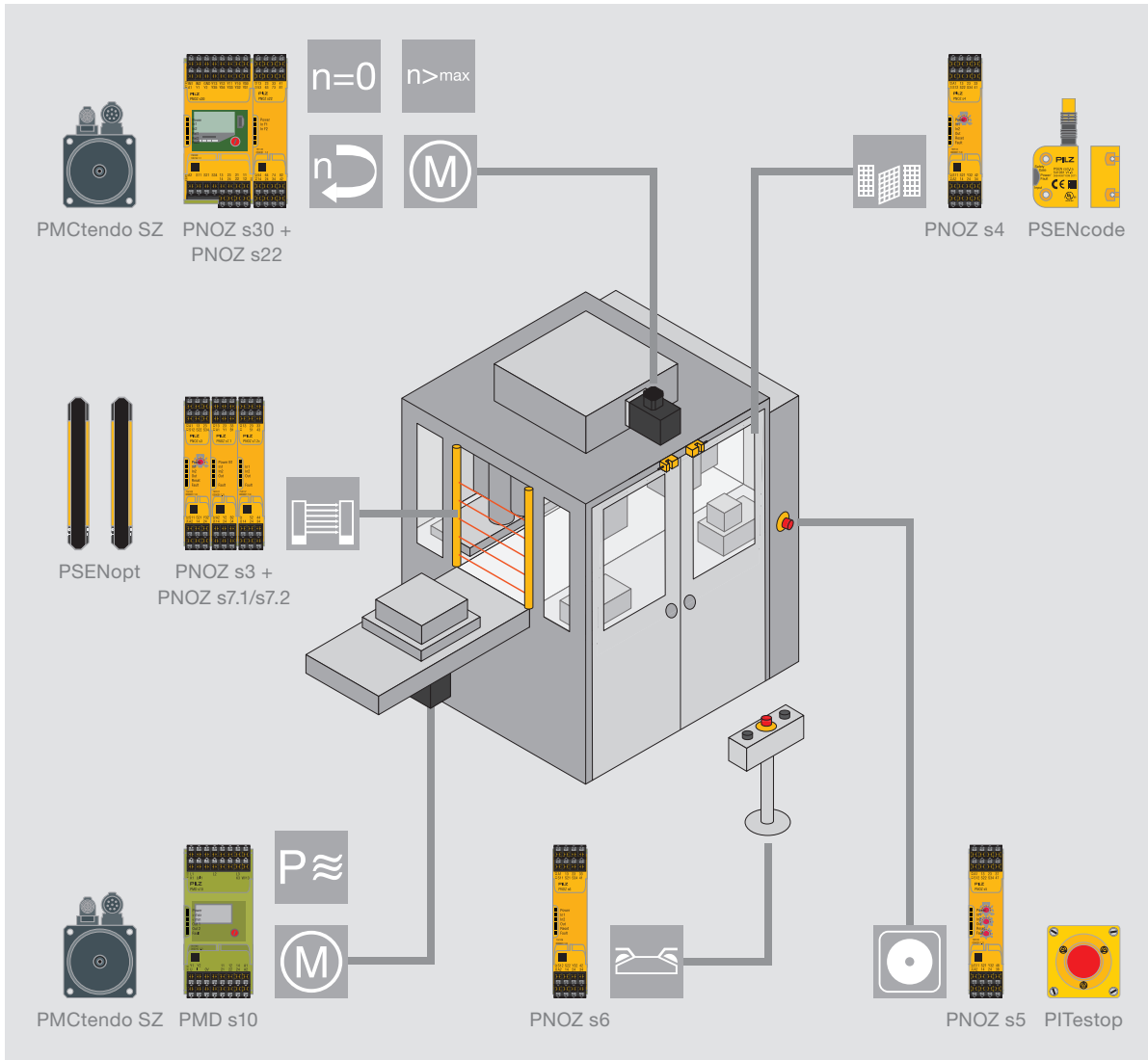

The appropriate solution for every safety application – e.g. use of the safety relays PNOZsigma on a packaging machine.



Keep up-to-date on safety relays PNOZsigma:

Webcode: web150099

Online information at [www.pilz.com](http://www.pilz.com)

## ► Safety relay PNOZsigma – tried and tested in special applications

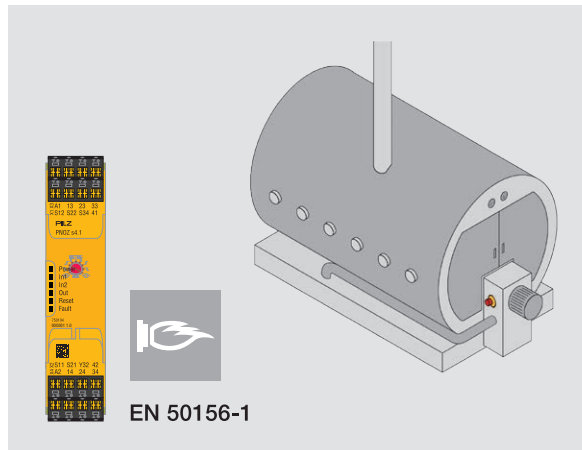

### Safety relay PNOZ s4.1 – for use in burner controls

Thanks to three safe, diverse safety contacts, the PNOZ s4.1 is approved for use in burner controls. It is approved in accordance with the standard EN 50156-1 for electrical equipment on furnaces, in particular with regard to the requirements for application design and installation. Safety valves of furnaces can be monitored using PNOZ s4.1. The operating modes can be set easily and conveniently using a rotary switch.

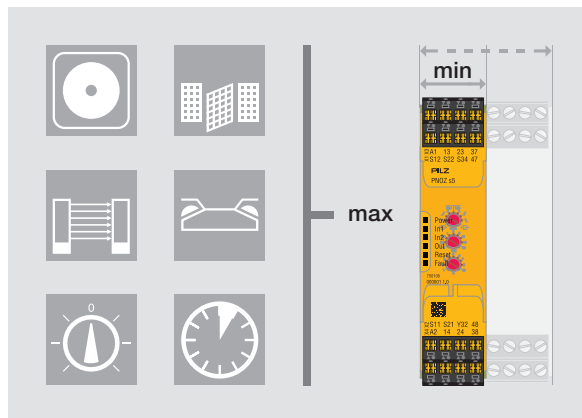

### Up to 50 % space saving

- Widths starting at 12.5 mm
- Housing is up to 50 % narrower with the same functionality <sup>1)</sup>
- Reduced space requirement in the control cabinet saves costs

<sup>1)</sup> Compared to standard electromechanical safety relays available on the market

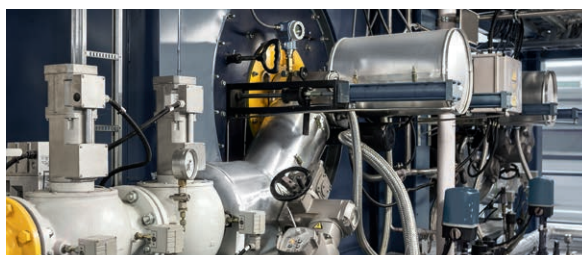

# ► More contacts with PNOZsigma – simply and quickly

## Multiple expansion with PNOZ s7.1 and PNOZ s7.2

Using a base unit and a PNOZ s7.1, it is possible to expand the number of safety contacts almost without limit. A series of up to ten PNOZ s7.2 units can be connected to a PNOZ s7.1. If you need even more safety contacts, an additional PNOZ s7.1 can be added. No wiring is involved – just a connector and one simple hand movement.

At just 17.5 mm wide, the PNOZ s7.1 has three safety contacts, while the PNOZ s7.2 has four safety contacts plus one auxiliary contact. They can be combined with other PNOZsigma expansion units at any time.

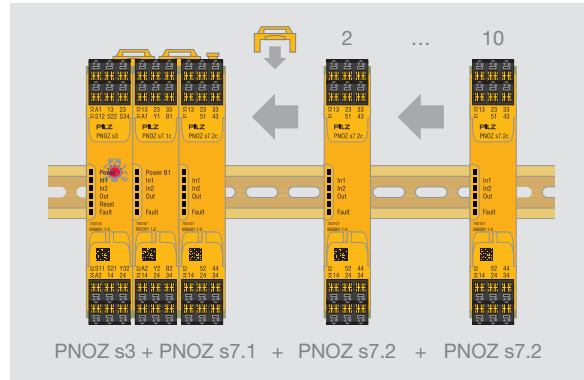

Fast contact expansion – it's easy with PNOZsigma!

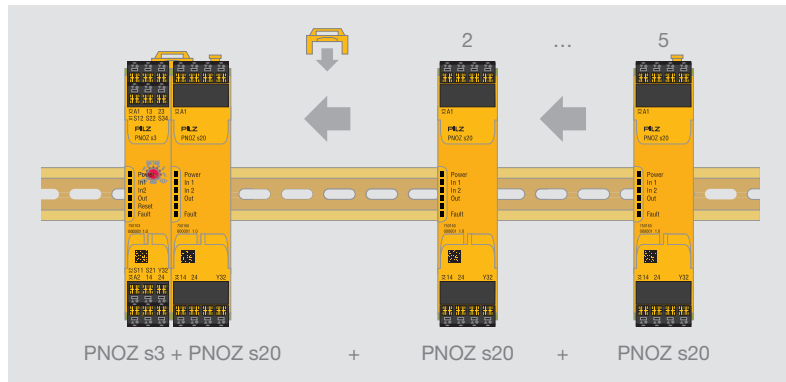

Fast contact expansion – with PNOZsigma also possible completely free of wear! Up to 5 contact expansion modules PNOZ s20 are possible at the base unit.

## Contact expansion module PNOZ s20 with safe semiconductor outputs

Apart from contact expansion with instantaneous safety contacts, contact expansion with safe semiconductor outputs is also available. If you need a maximum of ten semiconductor outputs, then connect the contact expansion module PNOZ s20 directly to a base unit. If you require even more safe semiconductor outputs, connect the contact expansion module PNOZ s7.1; with this module, you can then expand the number of semiconductor outputs to the desired number.

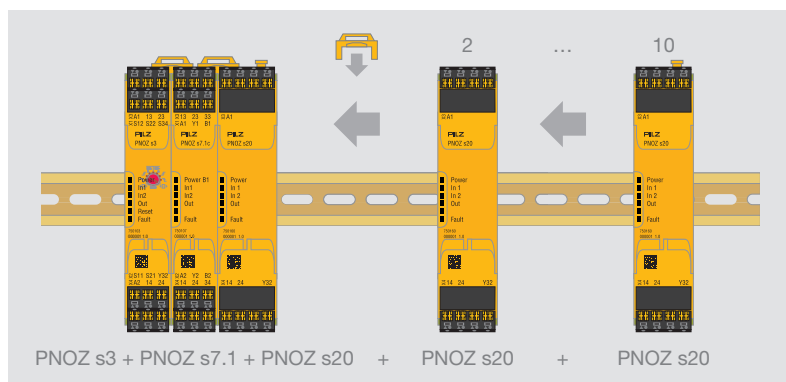

Expansion almost without limit – in conjunction with the contact expansion module PNOZ s7.1.

### Your benefits at a glance

- Wiring work is reduced by 20 % by expanding the contacts via connectors
- Flexible application as the number of safety contacts and semiconductor outputs can be expanded through cascading

Keep up-to-date on safety relays PNOZsigma:

Webcode: web150099

Online information at [www.pilz.com](http://www.pilz.com)

## ► Safety relay PNOZ s30 – Convenient speed moni



SSR



SSM



SDI



SOS

The stand-alone safety relay PNOZ s30 ensures safe monitoring of your machines for standstill, speed, position, shear pin breakage, speed range and direction of rotation up to PL e of EN ISO 13849-1 and up to SIL CL 3 of EN/IEC 62061. Using the PNOZ s30 ensures compliance with the Machinery Directive with respect to drive monitoring, i.e. the requirement to safely monitor and maintain the operating status of the drive when the drive is shut down. With PNOZ s30, you save costs and protect your machine and personnel.



PNOZ s30

### Increased safety of operating personnel

Movement at reduced speed during set-up mode, for example, increases operator safety and reduces set-up times. Safe working with the safety gate open or faster access to the machine once standstill is initiated protect you and your products and increase productivity.

### Simple use

The speed monitor PNOZ s30 is suitable for all common motor feedback systems and proximity switches. The configurable analog output transmits the safely measured speed to the controller, allowing you to dispense with additional sensors for speed detection. A safe output signal is also used here to indicate when any values exceed or fall below defined warning thresholds. Furthermore, up to three safety functions can be logically linked together (AND and OR).

### User-friendly configuration

The individual configuration is performed quickly and easily with the PNOZsigma Configurator using a PC. You can create and store new configurations, and existing ones can be read, copied and edited. It is also possible to change settings directly on the device using the rotary knob via the illuminated display.

### Applications

Choose PNOZ s30 for applications such as balancing machines, high rack storage systems, centrifuges, filling systems, wind turbines or even amusement parks. PNOZ s30 is the right solution for stand-alone monitoring of safety functions in accordance with EN 61800-5-2, such as speed range (SSR), safe speed monitoring (SSM), safe direction (SDI) and safe operating stop (SOS).





toring

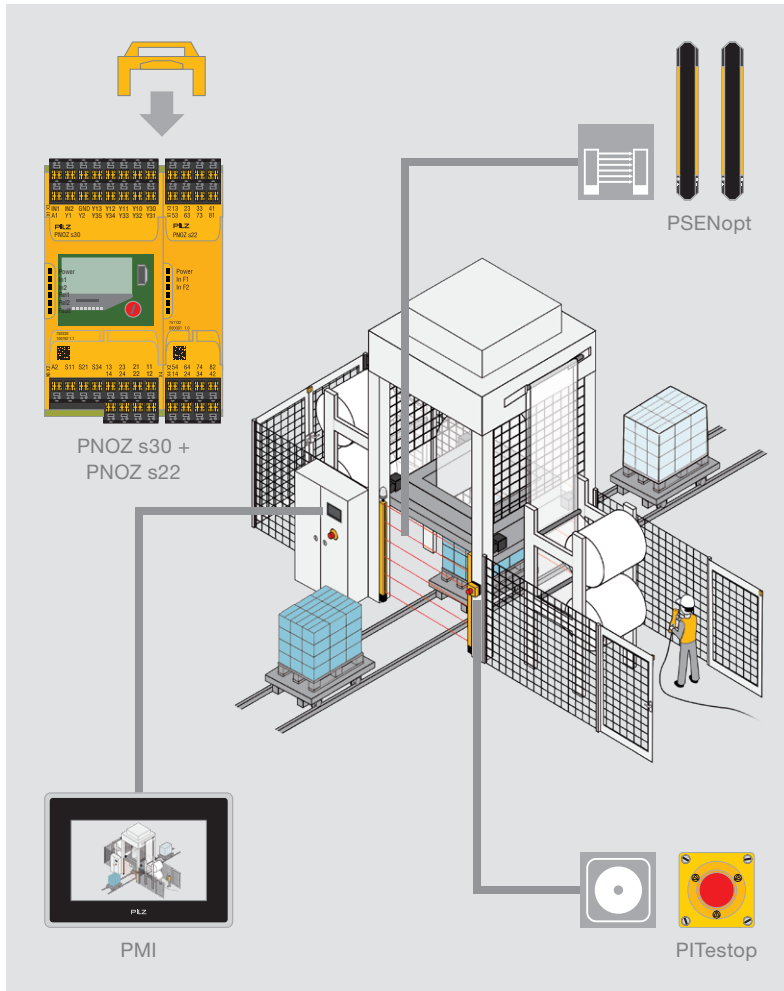

**Your benefits at a glance**

- ▶ Increased productivity and safety for operating personnel
- ▶ Productivity is increased by avoiding unnecessary shutdown processes: advance warning is given when a defined warning threshold is reached
- ▶ Saves time when setting up and when replacing devices thanks to the user-friendly PNOZsigma Configurator
- ▶ Suitable for all common motor feedback systems and proximity switches
- ▶ Contact expansion module PNOZ s22: Duplication of the relay contacts enables the application's function range to be expanded
- ▶ Configurable analog output for transmitting the safely measured speed to the controller
- ▶ Logical AND and OR link of up to three safety functions

The number of relay contacts can be multiplied by combining PNOZ s30 and PNOZ s22.

**Contact expansion module PNOZ s22 – twice as good**

PNOZ s22 provides two relay functions which can be controlled separately and which comply with PL e of EN ISO 13849-1. Each relay function provides three N/O contacts and one N/C contact. These can be controlled separately so that the outputs can be assigned different functions, depending on the base unit. Safe separation between the two relay functions enables different potentials to be switched.



PNOZ s22

Keep up-to-date on safety relays PNOZ s30:

Webcode: web150619

Online information at [www.pilz.com](http://www.pilz.com)

## ► Safety relay PNOZ s50 for safe brake control

The stand-alone safety relay PNOZ s50 provides a cost-effective solution for controlling two brakes up to category PL e of EN ISO 13849-1. The contactless technology allows very short reaction times to be achieved, enhancing personal protection. You can take advantage of the full flexibility and the individual shutdown options for your application of this manufacturer-independent solution.



PNOZ s50

### Safe, contactless braking – so it's non-wearing

PNOZ s50 helps to make your plant energy efficient: application cycle times are shortened because temporary overexcitation is followed by selectable voltage reduction (pulse width modulation PWM). The safety relay enables rapid switching in emergency situations and slow, low-wearing switching in normal operation, thereby helping to reduce maintenance costs.

As an addition to the PNOZsigma product range, PNOZ s50 also has a rotary knob for menu navigation and a display for the visualization of set-up parameters and diagnostic messages.

Both motor brakes and safety brakes can be safely controlled and monitored with the safety relay PNOZ s50. Safety is significantly improved due to “wear monitoring”, particularly on motor-integrated holding brakes.

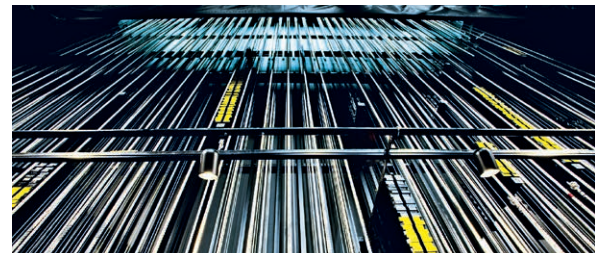

### Safety relay PNOZ s50



Find out more in the animation for the safety relay PNOZ s50.



PNOZ s50

#### Technical features

- Stand-alone unit
- 2 brakes up to PL e of EN ISO 13849-1/  
SIL CL 3 of EN/IEC 62061
- 1 brake up to PL d of EN ISO 13849-1/  
SIL CL 3 of EN/IEC 62061
- 2 x 2-pole safe electronic digital outputs  
for 24 VDC, each with 4.5 A
- Certifications:  
CE, cULus Listed, EAC (Eurasian), TÜV
- Temporary overexcitation with subsequent  
voltage reduction
- Ambient temperature: 0 ... 45 °C
- Number of inputs:
  - Failsafe: 4
  - Standard: 4
- Number of failsafe semiconductor outputs:
  - 1-pole: 3
  - 2-pole: 2

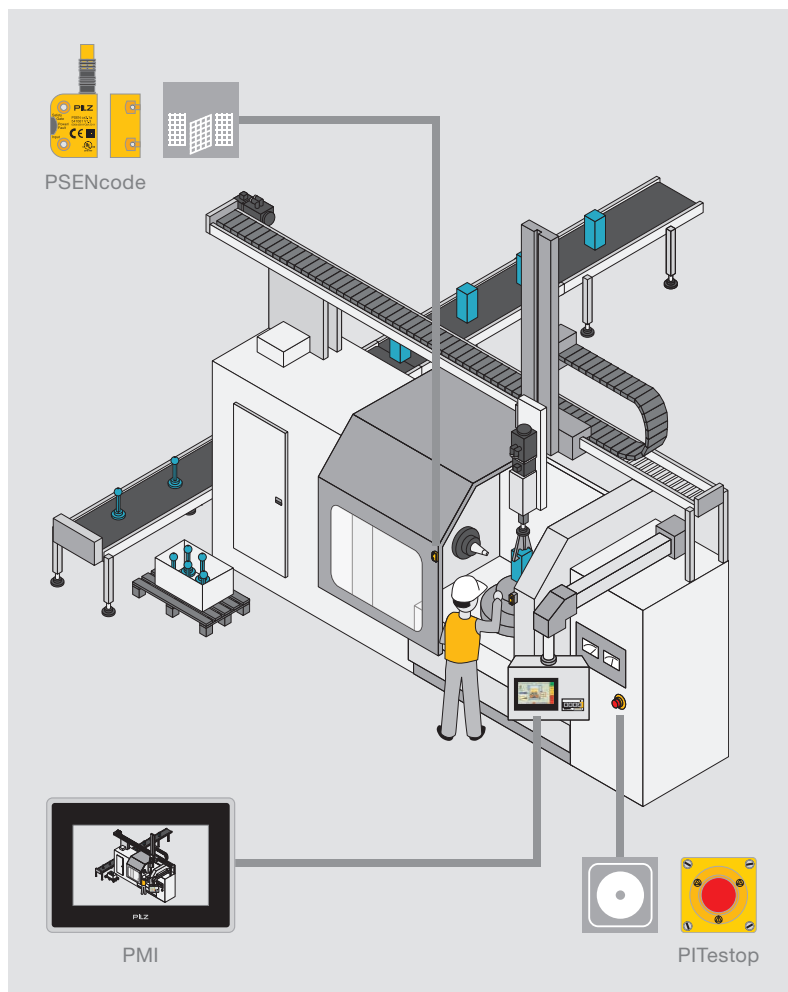

With the safety relay PNOZ s50, you can safely control braking in many application areas – e.g. in stage technology, on tooling machines and on packaging machines. If, in addition to the holding brake, you also need to safeguard a second brake, then PNOZ s50 provides you with the ideal solution.

#### Your benefits at a glance

- ▶ Highest level of safety up to PL e when controlling 2 brakes (holding brakes or safety brakes)
- ▶ Contactless technology up to 4.5 A per brake enables short reaction times, a long-lasting solution and high availability
- ▶ Reduced cycle times through temporary overexcitation with subsequent voltage reduction
- ▶ High safety and low wear on the brake thanks to fast and slow shutdown of the power circuits
- ▶ Rapid diagnostics by means of the display
- ▶ Manufacturer-independent brake control thanks to safe, digital inputs

- ▶ Supply voltage:
  - 1-pole: 24 VDC
  - 2-pole: 24 VDC, 48 VDC
- ▶ Voltage tolerance:
  - 1-pole: -15 % ... +20 %
  - 2-pole: -10 % ... +10 %
- ▶ Output current of semiconductor outputs (1-pole): 0.1 A
- ▶ Test pulse outputs of semiconductor outputs (1-pole): 2

- ▶ Reduced voltage of semiconductor outputs (2-pole): 6 V, 8 V, 12 V, 16 V, 24 V
- ▶ Output current of semiconductor outputs (2-pole):
  - 24 VDC supply voltage:
    - Continuous duty (1 output/2 outputs): 1 x 6.5 A/2 x 4.5 A
    - Overexcitation (1 output/2 outputs): 1 x 6.5 A/max. 10 A
  - 48 VDC supply voltage:
    - Continuous duty (1 output/2 outputs): 1 x 3.25 A/2 x 2.25 A
    - Overexcitation (1 output/2 outputs): 1 x 3.25 A/2 x 3.25 A

#### Order number

751 500  
(with spring-loaded terminals)

Keep up-to-date on safety relays PNOZ s50:

 Webcode: web150117

Online information at [www.pilz.com](http://www.pilz.com)

## ► Selection guide – PNOZsigma

### Safety relays PNOZsigma

Type	Application	Performance Level (PL) – EN ISO 13849-1	Safety Integrity Level (SIL) CL claim limit in accordance with EN/IEC 62061
			
PNOZ s1	◆ ◆	c	2
PNOZ s2	◆ ◆	e	3
PNOZ s3	◆ ◆ ◆	e	3
PNOZ s4	◆ ◆ ◆	e	3
PNOZ s4.1	◆ ◆ ◆	e	3
PNOZ s5	◆ ◆ ◆ ◆	e	3
PNOZ s6		EN 574, Type IIIC	e
PNOZ s6.1		EN 574, Type IIIA	c
PNOZ s7	Contact expansion	e	3
PNOZ s7.1	Contact expansion	e	3
PNOZ s7.2	Contact expansion	e	3
PNOZ s8	Contact expansion	c	2
PNOZ s9	Contact expansion or safe timer	e	3
PNOZ s10	Contact expansion	e	3
PNOZ s11	Contact expansion	e	3
PNOZ s20	Contact expansion	e/d <sup>2)</sup>	3/2 <sup>2)</sup>
PNOZ s22	Contact expansion for PNOZ s30 and PNOZ mm0.1p/mm0.2p	e	3

Type	Application	Performance Level (PL) – EN ISO 13849-1	Safety Integrity Level (SIL) CL claim limit in accordance with EN/IEC 62061
			
PNOZ s30	Safe speed and standstill monitor	e	3
	◆ ◆ ◆		

Type	Application	Performance Level (PL) – EN ISO 13849-1	Safety Integrity Level (SIL) CL claim limit in accordance with EN/IEC 62061
			
PNOZ s50 <sup>3)</sup>	Safe brake control	e	3
	◆		

Output contacts				Semiconductor outputs		Supply voltage (U <sub>B</sub> )	Dimensions (H x W x D) in mm
Safe		Auxiliary contacts		Safe	Auxiliary outputs		
						24 VDC	100/98 <sup>1)</sup> x 12.5 x 120
2	-	-	1	-	-	24 VDC	100/98 <sup>1)</sup> x 17.5 x 120
3	-	1	1	-	-	24 VDC	100/98 <sup>1)</sup> x 17.5 x 120
2	-	-	1	-	-	24 VDC	100/98 <sup>1)</sup> x 17.5 x 120
3	-	1	1	-	-	24 VDC, 48 ... 240 VAC/DC	100/98 <sup>1)</sup> x 22.5 x 120
3	-	1	1	-	-	24 VDC, 48 ... 240 VAC/DC	100/98 <sup>1)</sup> x 22.5 x 120
2	2	-	1	-	-	24 VDC, 48 ... 240 VAC/DC	100/98 <sup>1)</sup> x 22.5 x 120
3	-	1	1	-	-	24 VDC, 48 ... 240 VAC/DC	100/98 <sup>1)</sup> x 22.5 x 120
3	-	1	1	-	-	24 VDC, 48 ... 240 VAC/DC	100/98 <sup>1)</sup> x 22.5 x 120
4	-	1	-	-	-	24 VDC	100/98 <sup>1)</sup> x 17.5 x 120
3	-	-	-	-	-	24 VDC	100/98 <sup>1)</sup> x 17.5 x 120
4	-	1	-	-	-	24 VDC	100/98 <sup>1)</sup> x 17.5 x 120
2	-	-	1	-	-	24 VDC	100/98 <sup>1)</sup> x 12.5 x 120
-	3	1	-	-	-	24 VDC	100/98 <sup>1)</sup> x 17.5 x 120
4	-	1	-	-	-	24 VDC	100/98 <sup>1)</sup> x 45.0 x 120
8	-	1	-	-	-	24 VDC	100/98 <sup>1)</sup> x 45.0 x 120
-	-	-	-	2	1	24 VDC	100/98 <sup>1)</sup> x 22.5 x 120
2x3	-	2x1	-	-	-	24 VDC	100/98 <sup>1)</sup> x 22.5 x 120

Output contacts				Semiconductor outputs		Supply voltage (U <sub>B</sub> )	Dimensions (H x W x D) in mm
Safe		Auxiliary contacts		Safe	Auxiliary outputs		
						24 ... 240 VAC/DC	100/98 <sup>1)</sup> x 45.0 x 120
2	-	2	4	-	-	24 ... 240 VAC/DC	100/98 <sup>1)</sup> x 45.0 x 120

Semiconductor outputs		Semiconductor outputs		Supply voltage (U <sub>B</sub> )	Dimensions (H x W x D) in mm
2-pin	1-pin	Safe	Auxiliary outputs		
				24 VDC, 48 VDC	100/98 <sup>1)</sup> x 45.0 x 120
2	3	-	-	24 VDC, 48 VDC	100/98 <sup>1)</sup> x 45.0 x 120

Technical documentation on safety relays PNOZsigma:

Webcode: web150635

Online information at [www.pilz.com](http://www.pilz.com)

<sup>1)</sup> Height incl. spring-loaded terminals/plug-in screw terminals

<sup>2)</sup> Depending on the application

<sup>3)</sup> For technical details, see page 26

## ► Technical details – PNOZsigma

### Safety relays PNOZsigma – Base units



PNOZ s1



PNOZ s2



PNOZ s3



PNOZ s4



PNOZ s4.1



PNOZ s5



PNOZ s6



PNOZ s6.1

Type	Features
PNOZ s1	<ul style="list-style-type: none"> <li>▶ Single-channel wiring</li> <li>▶ Manual/automatic start</li> </ul>
PNOZ s2	<ul style="list-style-type: none"> <li>▶ Single-channel wiring</li> <li>▶ Monitored start</li> <li>▶ Manual/automatic start</li> <li>▶ Safe separation</li> </ul>
PNOZ s3	<ul style="list-style-type: none"> <li>▶ Single- and dual-channel wiring</li> <li>▶ Detection of shorts across contacts</li> <li>▶ Monitored start</li> <li>▶ Manual/automatic start</li> <li>▶ Start-up testing</li> </ul>
PNOZ s4	<ul style="list-style-type: none"> <li>▶ Single- and dual-channel wiring</li> <li>▶ Detection of shorts across contacts</li> <li>▶ Monitored start</li> <li>▶ Manual/automatic start</li> <li>▶ Start-up testing</li> <li>▶ Approval to EN 81-1/A3 in accordance with the Lifts Directive</li> </ul>
PNOZ s4.1	<ul style="list-style-type: none"> <li>▶ Single- and dual-channel wiring</li> <li>▶ Detection of shorts across contacts</li> <li>▶ Monitored start</li> <li>▶ Manual/automatic start</li> <li>▶ Start-up testing</li> <li>▶ 3 safe, diverse safety contacts</li> <li>▶ Approval in accordance with EN 50156-1 for electrical equipment for furnaces</li> </ul>
PNOZ s5	<ul style="list-style-type: none"> <li>▶ Single- and dual-channel wiring</li> <li>▶ Detection of shorts across contacts</li> <li>▶ Monitored start</li> <li>▶ Manual/automatic start</li> <li>▶ Start-up testing</li> <li>▶ Timer functions: delay-on de-energization</li> <li>▶ Time range: 0 ... 300 s</li> </ul>
PNOZ s6	<ul style="list-style-type: none"> <li>▶ Dual-channel wiring</li> <li>▶ Detection of shorts across contacts</li> </ul>
PNOZ s6.1	<ul style="list-style-type: none"> <li>▶ Dual-channel wiring</li> <li>▶ Detection of shorts across contacts</li> </ul>

Outputs: Voltage/current/rating	Certification	Order number	
		Spring-loaded terminals	Plug-in screw terminals
DC1: 24 V/3 A/72 W	CE, cULus Listed, EAC (Eurasian), TÜV, KOSHA, CCC	751 101	750 101
DC1: 24 V/6 A/150 W	CE, cULus Listed, EAC (Eurasian), TÜV, KOSHA, CCC	751 102	750 102
DC1: 24 V/6 A/150 W	CE, cULus Listed, EAC (Eurasian), TÜV, KOSHA, CCC	751 103	750 103
DC1: 24 V/6 A/150 W	CE, cULus Listed, EAC (Eurasian), TÜV, KOSHA, CCC	▶ 24 VDC _____ 751 104 ▶ 24 VDC, coated version _____ 751 184 ▶ 48 ... 240 VAC/DC __ 751 134	▶ 24 VDC _____ 750 104 ▶ 48 ... 240 VAC/DC __ 750 134
DC1: 24 V/6 A/150 W	CE, cULus Listed, EAC (Eurasian), TÜV, CCC	▶ 24 VDC _____ 751 124 ▶ 48 ... 240 VAC/DC __ 751 154	▶ 24 VDC _____ 750 124 ▶ 48 ... 240 VAC/DC __ 750 154
DC1: 24 V/6 A/150 W	CE, cULus Listed, EAC (Eurasian), TÜV, KOSHA, CCC	▶ 24 VDC _____ 751 105 ▶ 24 VDC, coated version _____ 751 185 ▶ 48 ... 240 VAC/DC __ 751 135	▶ 24 VDC _____ 750 105 ▶ 48 ... 240 VAC/DC __ 750 135
DC1: 24 V/6 A/150 W	CE, cULus Listed, EAC (Eurasian), TÜV, KOSHA, CCC	▶ 24 VDC _____ 751 106 ▶ 48 ... 240 VAC/DC __ 751 136	▶ 24 VDC _____ 750 106 ▶ 48 ... 240 VAC/DC __ 750 136
DC1: 24 V/6 A/150 W	CE, cULus Listed, EAC (Eurasian), TÜV, KOSHA, CCC	▶ 24 VDC _____ 751 126 ▶ 48 ... 240 VAC/DC __ 751 156	▶ 24 VDC _____ 750 126 ▶ 48 ... 240 VAC/DC __ 750 156

Technical documentation on safety relays PNOZsigma:

 Webcode: web150635

Online information at [www.pilz.com](http://www.pilz.com)

## ► Technical details – PNOZsigma

### Safety relays PNOZsigma – Contact expansion modules



PNOZ s7



PNOZ s8



PNOZ s9



PNOZ s10



PNOZ s11



PNOZ s20



PNOZ s22

Type	Features
PNOZ s7	Safe separation
PNOZ s7.1	<ul style="list-style-type: none"> <li>▶ Cascading module for connection to PNOZ s7.2</li> <li>▶ Safe separation of safety contacts</li> <li>▶ LEDs for input and switch status</li> <li>▶ Can also be used with other safety control devices, without a PNOZsigma base unit: one input circuit affects the output relays</li> </ul>
PNOZ s7.2	Contact expansion module in conjunction with PNOZ s7.1
PNOZ s8	Contact expansion
PNOZ s9	<ul style="list-style-type: none"> <li>▶ Safe separation</li> <li>▶ Timer functions: delay-on energization, delay-on de-energization, pulsing, retriggerable</li> <li>▶ Time range: 0 ... 300 s</li> </ul>
PNOZ s10	Safe separation
PNOZ s11	Safe separation
PNOZ s20	<ul style="list-style-type: none"> <li>▶ Contact expansion with 2 instantaneous safety outputs and 1 auxiliary output, each in semiconductor technology</li> <li>▶ Single- and dual-channel wiring</li> </ul>
PNOZ s22	<ul style="list-style-type: none"> <li>▶ 2 safety contacts that can be controlled separately</li> <li>▶ Contact expansion for speed monitor PNOZ s30 and base units PNOZ mm0.1p/mm0.2p of configurable compact controllers PNOZmulti Mini</li> </ul>

### Safety relays PNOZsigma – Speed monitoring



PNOZ s30

Type	Features
PNOZ s30	<ul style="list-style-type: none"> <li>▶ Safe monitoring of standstill, speed, position and speed range</li> <li>▶ Convenient configuration with PNOZsigma Configurator or parameter entry via rotary knob in conjunction with an illuminated display</li> <li>▶ Set parameters are saved on a chip card</li> <li>▶ Diagnostics via illuminated display</li> <li>▶ Configurable analog output</li> </ul>



Outputs: Voltage/current/rating	Certification	Order number	
		Spring-loaded terminals	Plug-in screw terminals
DC1: 24 V/6 A/150 W	CE, cULus Listed, EAC (Eurasian), TÜV, KOSHA, CCC	<ul style="list-style-type: none"> <li>▶ 24 VDC _____ 751 107</li> <li>▶ 24 VDC, coated version _____ 751 187</li> </ul>	750 107
DC1: 24 V/6 A/150 W	CE, cULus Listed, EAC (Eurasian), TÜV, CCC	751 167	750 167
DC1: 24 V/6 A/150 W	CE, cULus Listed, EAC (Eurasian), TÜV, CCC	751 177	750 177
DC1: 24 V/3 A/72 W	CE, cULus Listed, EAC (Eurasian), TÜV, KOSHA, CCC	751 108	750 108
DC1: 24 V/6 A/150 W	CE, cULus Listed, EAC (Eurasian), TÜV, KOSHA, CCC	<ul style="list-style-type: none"> <li>▶ 24 VDC _____ 751 109</li> <li>▶ 24 VDC, coated version _____ 751 189</li> </ul>	750 109
DC1: 24 V/12 A/300 W	CE, cULus Listed, EAC (Eurasian), TÜV, KOSHA, CCC	751 110	750 110
DC1: 24 V/6 A/150 W	CE, cULus Listed, EAC (Eurasian), TÜV, CCC	751 111	750 111
<ul style="list-style-type: none"> <li>▶ Total output of external load, semiconductor 93 W</li> <li>▶ Switching capability:                             <ul style="list-style-type: none"> <li>- 2 safety outputs with load: 1.5 A/40 W</li> <li>- 1 safety output with load: 2 A/50 W</li> </ul> </li> </ul>	CE, cULus Listed, EAC (Eurasian), TÜV, CCC	751 160	750 160
DC1: 24 V/6 A/150 W	cULus Listed, EAC (Eurasian), TÜV, CCC	751 132	750 132

	Outputs: Voltage/current/rating	Certification	Order number
<ul style="list-style-type: none"> <li>▶ Safety functions in accordance with EN 61800-5-2</li> <li>▶ Advance warning of shutdown when a certain threshold is reached</li> <li>▶ Accessories:                             <ul style="list-style-type: none"> <li>- Chip card reader: 779230</li> <li>- PNOZsigma chip card manager set: 750030</li> <li>- PNOZ s30 USB configuration cable: 750040</li> <li>- PNOZsigma Configurator s30 License unltid: 750700</li> <li>- PNOZsigma Configurator s30 License 1 y: 750701</li> </ul> </li> </ul>	DC1: 24 V/4 A/100 W	CE, cULus Listed, EAC (Eurasian), TÜV, CCC	<ul style="list-style-type: none"> <li>▶ 751 330 (spring-loaded terminals)</li> <li>▶ 750 330 (plug-in screw terminals)</li> </ul>

Technical documentation on safety relays PNOZsigma:

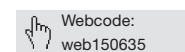

Webcode:  
web150635

Online information at [www.pilz.com](http://www.pilz.com)

## ▶ Safety relays PNOZ X

Safety relays from the product group PNOZ X are proven through their reliability and robustness and have a wide application area in the most varied of safety applications. PNOZ is the most widely used safety relay in the world. One PNOZ is used per safety function.

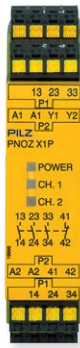

PNOZ X1P

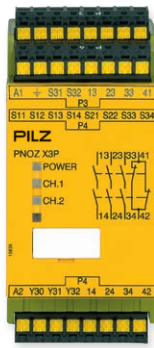

PNOZ X3P

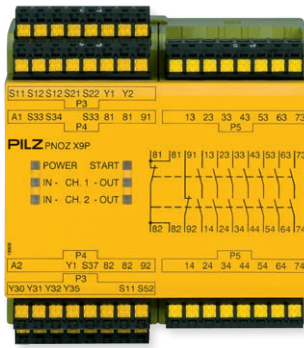

PNOZ X9P

### Customized safety for each application

Technical features are the voltage-free, electromechanical contacts in 2-relay technology. The sizes vary from 22.5 to 90 mm, the number of contacts from two to eight. Whatever your safety requirement – PNOZ X has already proved itself a million times over in tough industrial environments. Why not take advantage!



### Your benefits at a glance

- ▶ Technology proven over many years of use
- ▶ Huge selection of products
- ▶ For all safety functions such as monitoring E-STOP devices, safety gates, light beam devices, muting, pressure-sensitive mats and two-hand control and many more
- ▶ Delayed and instantaneous contact expansion modules, safe timers, safe monitoring relays for standstill, speed and other functions
- ▶ Excellent price/performance ratio
- ▶ Rapid commissioning thanks to plug-in terminals
- ▶ Maximum safety with minimum space requirement
- ▶ Complete solution comprising evaluation devices, compatible sensor technology, control and signal devices
- ▶ Low storage costs thanks to universal power supply and plug-in terminals

Keep up-to-date  
on safety relays  
PNOZ X:

Webcode:  
web150097

Online information  
at [www.pilz.com](http://www.pilz.com)

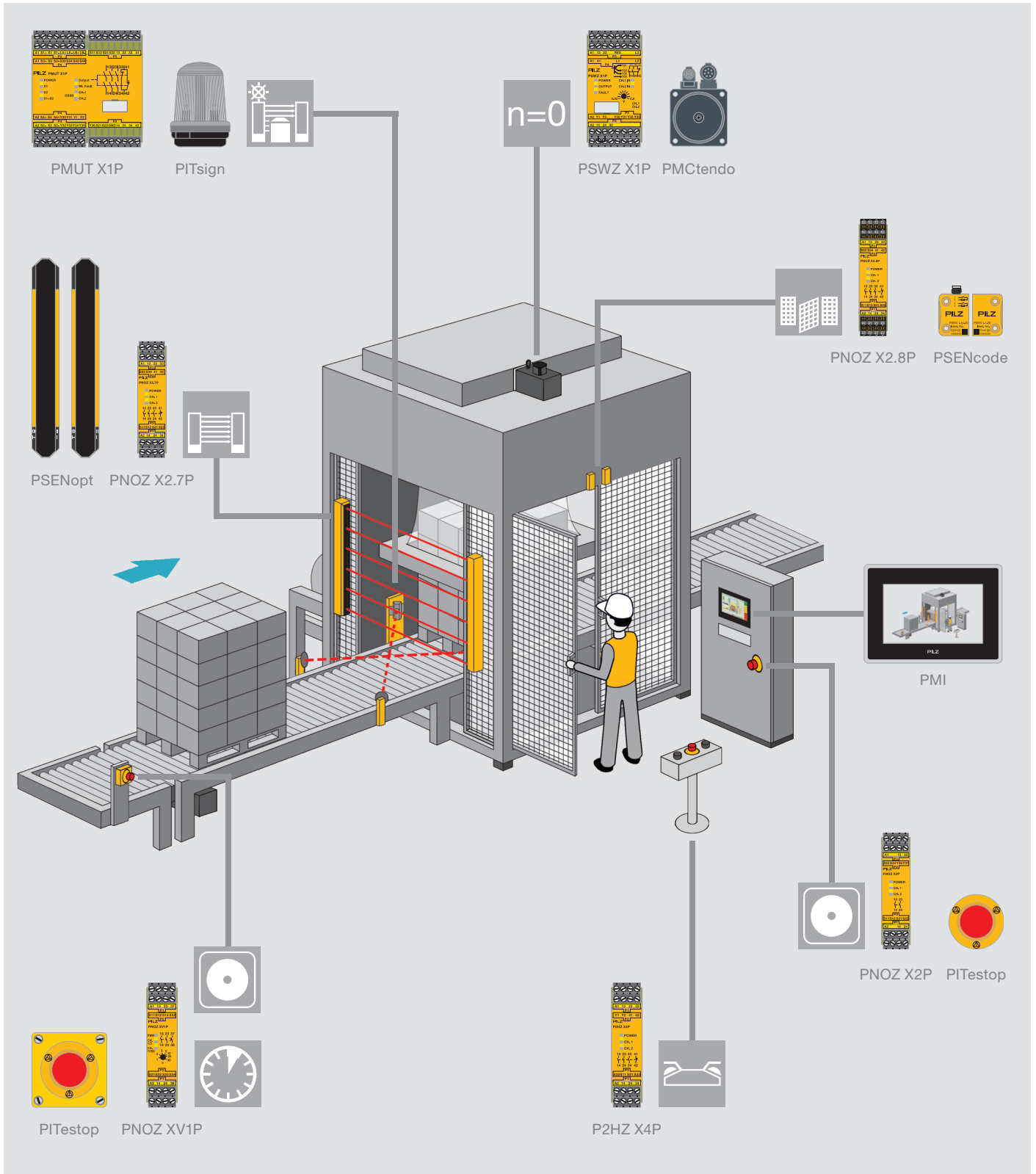





Example: using safety relays PNOZ X on a packaging machine.

## ► Selection guide – PNOZ X

### Safety relays PNOZ X

Type	Application	Performance Level (PL) – EN ISO 13849-1
PNOZ X1P	◆ ◆	e
PNOZ X2P	◆ ◆	e
PNOZ X2.7P	◆ ◆ ◆	e
PNOZ X2.8P	◆ ◆ ◆	e
PNOZ X3P	◆ ◆ ◆	e
PNOZ X7P	◆ ◆	e
PNOZ X8P	◆ ◆ ◆	e
PNOZ X9P	◆ ◆ ◆	e
PNOZ X10.11P	◆ ◆ ◆	e
PNOZ X11P	◆ ◆ ◆	e
PNOZ XV1P	◆ ◆ ◆	e (d) <sup>2)</sup>
PNOZ XV3P	◆ ◆ ◆	e (d) <sup>2)</sup>
PNOZ XV3.1P	◆ ◆ ◆	e (d) <sup>2)</sup>
PMUT X1P	◆ ◆ ◆	e
P2HZ X1P	◆	EN 574, Type IIIC e
P2HZ X4P	◆	EN 574, Type IIIC e
PSWZ X1P	◆	e
PZE X4P	Contact expansion	e

Safety Integrity Level (SIL) CL claim limit in accordance with EN/IEC 62061	Output contacts				Supply voltage (U <sub>B</sub> )	Dimensions (H x W x D) in mm
	Safe		Non-safe			
						
3	3	-	1	-	24 VDC	101/94 <sup>1)</sup> x 22.5 x 121
3	2	-	-	-	▶ 24 VAC/DC ▶ 48 ... 240 VAC/DC	101/94 <sup>1)</sup> x 22.5 x 121
3	3	-	1	-	▶ 24 VAC/DC ▶ 24 ... 240 VAC/DC	101/94 <sup>1)</sup> x 22.5 x 121
3	3	-	1	-	▶ 24 VAC/DC ▶ 24 ... 240 VAC/DC	101/94 <sup>1)</sup> x 22.5 x 121
3	3	-	1	1	▶ 24 VAC/DC ▶ 24 ... 240 VAC/DC	101/94 <sup>1)</sup> x 45 x 121
3	2	-	-	-	▶ 24 VAC/DC ▶ 110 ... 120, 230 ... 240 VAC	101/94 <sup>1)</sup> x 22.5 x 121
3	3	-	2	2	▶ 24 VDC ▶ 24, 110, 230 VAC	101/94 <sup>1)</sup> x 45 x 121
3	7	-	2	2	▶ 12 VDC ▶ 24 VDC, 100 ... 240 VAC	101/94 <sup>1)</sup> x 90 x 121
3	6	-	4	-	24 VDC	101/94 <sup>1)</sup> x 90 x 121
3	7	-	1	2	▶ 24 VDC, 24 VAC ▶ 110 ... 120, 230 ... 240 VAC	101/94 <sup>1)</sup> x 90 x 121
3	2	1	-	-	24 VDC	101/94 <sup>1)</sup> x 22.5 x 121
3	3	2	-	-	24 VDC	101/94 <sup>1)</sup> x 45 x 121
3	3	2	1	-	▶ 24 VDC ▶ 24 ... 240 VAC/DC	101/94 <sup>1)</sup> x 90 x 121
3	3	-	1	5	24 VDC	101/94 <sup>1)</sup> x 90 x 121
3	3	-	1	2	▶ 24 VDC ▶ 24, 42, 110, 115, 230, 240 VAC	101/94 <sup>1)</sup> x 45 x 121
3	3	-	1	-	24 VAC/DC	101/94 <sup>1)</sup> x 22.5 x 121
3	2	-	1	1	24 ... 240 VAC/DC	101/94 <sup>1)</sup> x 45 x 121
3	4	-	-	-	24 VDC	101/94 <sup>1)</sup> x 22.5 x 121

<sup>1)</sup> Height incl. spring-loaded terminals/plug-in screw terminals

<sup>2)</sup> Value applies to instantaneous (delayed) safety contacts

Technical documentation on safety relays PNOZ X:

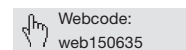

Online information at [www.pilz.com](http://www.pilz.com)

# ► Technical details – PNOZ X

## Safety relays PNOZ X



PNOZ X1P



PNOZ X2P



PNOZ X2.7P

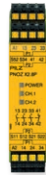

PNOZ X2.8P



PNOZ X3P



PNOZ X7P



PNOZ X8P

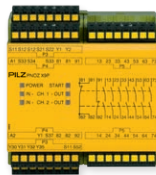

PNOZ X9P

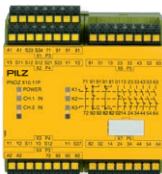

PNOZ X10.11P

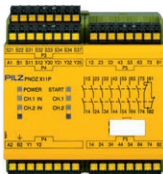

PNOZ X11P

Type	Features
PNOZ X1P	1-channel operation
PNOZ X2P	<ul style="list-style-type: none"> <li>▶ 2-channel operation with detection of shorts across contacts</li> <li>▶ Automatic or monitored start can be selected</li> </ul>
PNOZ X2.7P	<ul style="list-style-type: none"> <li>▶ 2-channel operation with or without detection of shorts across contacts</li> <li>▶ Monitored start</li> </ul>
PNOZ X2.8P	<ul style="list-style-type: none"> <li>▶ 2-channel operation with or without detection of shorts across contacts</li> <li>▶ Automatic start</li> </ul>
PNOZ X3P	<ul style="list-style-type: none"> <li>▶ Dual-channel wiring, with or without detection of shorts across contacts</li> <li>▶ Monitored or automatic start can be selected</li> <li>▶ 1 semiconductor output</li> </ul>
PNOZ X7P	1-channel operation
PNOZ X8P	<ul style="list-style-type: none"> <li>▶ 2-channel operation with or without detection of shorts across contacts</li> <li>▶ Monitored or automatic start can be selected</li> <li>▶ 2 semiconductor outputs</li> </ul>
PNOZ X9P	<ul style="list-style-type: none"> <li>▶ Dual-channel wiring, with or without detection of shorts across contacts</li> <li>▶ Monitored or automatic start can be selected</li> <li>▶ 2 semiconductor outputs</li> </ul>
PNOZ X10.11P	<ul style="list-style-type: none"> <li>▶ Dual-channel wiring, with or without detection of shorts across contacts</li> <li>▶ Monitored or automatic start can be selected</li> </ul>
PNOZ X11P	<ul style="list-style-type: none"> <li>▶ Dual-channel wiring, with or without detection of shorts across contacts</li> <li>▶ Monitored or automatic start can be selected</li> <li>▶ 2 semiconductor outputs</li> </ul>

Outputs: Voltage/current/rating	Certification	Order number	
		Spring-loaded terminals	Plug-in screw terminals
DC1: 24 V/6 A/150 W	CE, cULus Listed, EAC (Eurasia), TÜV, CCC	787 100	777 100
DC1: 24 V/6 A/150 W	CE, cULus Listed, EAC (Eurasia), TÜV, CCC	▶ 24 VAC/DC _____ 787 303 ▶ 48 ... 240 VAC/DC _____ 787 307	▶ 24 VAC/DC _____ 777 303 ▶ 48 ... 240 VAC/DC _____ 777 307
DC1: 24 V/6 A/150 W	CE, cULus Listed, EAC (Eurasia), TÜV, CCC	▶ 24 VAC/DC _____ 787 305 ▶ 24 ... 240 VAC/DC _____ 787 306	▶ 24 VAC/DC _____ 777 305 ▶ 24 ... 240 VAC/DC _____ 777 306
DC1: 24 V/6 A/150 W	CE, cULus Listed, EAC (Eurasia), TÜV, KOSHA, CCC	▶ 24 VAC/DC _____ 787 301 ▶ 24 ... 240 VAC/DC _____ 787 302	▶ 24 VAC/DC _____ 777 301 ▶ 24 ... 240 VAC/DC _____ 777 302
DC1: 24 V/8 A/200 W	CE, cULus Listed, EAC (Eurasia), TÜV, KOSHA, CCC	▶ 24 VAC/DC _____ 787 310 ▶ 24 ... 240 VAC/DC _____ 787 313	▶ 24 VAC/DC _____ 777 310 ▶ 24 ... 240 VAC/DC _____ 777 313
DC1: 24 V/6 A/150 W	CE, cULus Listed, EAC (Eurasia), TÜV, CCC	▶ 24 VAC/DC _____ 787 059 ▶ Others available on request	▶ 24 VAC/DC _____ 777 059 ▶ Others available on request
DC1: 24 V/8 A/200 W	CE, cULus Listed, EAC (Eurasia), TÜV, CCC	▶ 24 VDC _____ 787 760 ▶ Others available on request	▶ 24 VDC _____ 777 760 ▶ Others available on request
DC1: 24 V/8 A/200 W	CE, cULus Listed, EAC (Eurasia), TÜV, CCC	▶ 24 VDC _____ 787 609 ▶ 24 VDC, 100 ... 240 VAC _____ 787 606	▶ 12 VDC _____ 777 607 ▶ 24 VDC _____ 777 609 ▶ 24 VDC, 100 ... 240 VAC _____ 777 606
DC1: 24 V/8 A/200 W	CE, cULus Listed, EAC (Eurasia), TÜV, CCC	787 750	777 750
DC1: 24 V/8 A/200 W	CE, cULus Listed, EAC (Eurasia), TÜV, CCC	▶ 24 VDC, 24 VAC _____ 787 080 ▶ 110 ... 120 VAC _____ 787 083 ▶ 230 ... 240 VAC _____ 787 086	▶ 24 VDC, 24 VAC _____ 777 080 ▶ 110 ... 120 VAC, 24 VDC _____ 777 083 ▶ 230 ... 240 VAC, 24 VDC _____ 777 086

Technical documentation on safety relays PNOZ X:

 Webcode: web150635

Online information at [www.pilz.com](http://www.pilz.com)

## ► Technical details – PNOZ X

### Safety relays PNOZ X



PNOZ XV1P



PNOZ XV3P

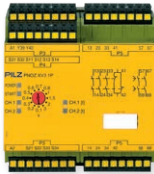

PNOZ XV3.1P

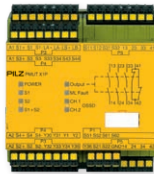

PMUT X1P

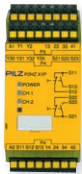

P2HZ X1P



P2HZ X4P



PSWZ X1P



PZE X4P

Type	Features
PNOZ XV1P	<ul style="list-style-type: none"> <li>► Dual-channel wiring, with or without detection of shorts across contacts</li> <li>► Monitored or automatic start can be selected</li> </ul>
PNOZ XV3P	<ul style="list-style-type: none"> <li>► Dual-channel wiring, with or without detection of shorts across contacts</li> <li>► Monitored or automatic start can be selected</li> </ul>
PNOZ XV3.1P	<ul style="list-style-type: none"> <li>► Dual-channel wiring, with or without detection of shorts across contacts</li> <li>► Monitored or automatic start can be selected</li> <li>► Universal power supply 24 ... 240 VAC/DC</li> </ul>
PMUT X1P	<ul style="list-style-type: none"> <li>► Up to 4 muting sensors</li> <li>► Monitoring and switching muting lamps</li> <li>► Parallel and sequential muting</li> <li>► Simultaneity monitoring</li> <li>► 5 semiconductor outputs</li> <li>► Reset input</li> <li>► Override function via key switch in the case of a fault</li> <li>► LED status indicators</li> </ul>
P2HZ X1P	2 semiconductor outputs
P2HZ X4P	22.5 mm width
PSWZ X1P	<ul style="list-style-type: none"> <li>► Safe standstill monitoring</li> <li>► 1 or 2-channel operation</li> <li>► No external components required</li> <li>► Fault signal if simultaneity time is exceeded</li> <li>► Reset input</li> <li>► Detects open circuits</li> </ul>
PZE X4P	1-channel operation



Outputs: Voltage/current/rating	Certification	Order number	
		Spring-loaded terminals	Plug-in screw terminals
DC1: 24 V/5 A/125 W	CE, cULus Listed, EAC (Eurasia), TÜV, CCC	▶ 0.1 ... 3 s _____ 787 601 ▶ 1 ... 30 s _____ 787 602	▶ 0.1 ... 3 s _____ 777 601 ▶ 1 ... 30 s _____ 777 602
DC1: 24 V/8 A/200 W	CE, cULus Listed, EAC (Eurasia), TÜV, CCC	▶ 3 s _____ 787 512 ▶ 30 s _____ 787 510 ▶ Others available on request	▶ 3 s _____ 777 512 ▶ 30 s _____ 777 510 ▶ Others available on request
DC1: 24 V/8 A/200 W	CE, cULus Listed, EAC (Eurasia), TÜV, CCC	▶ 3 s selectable, 24 ... 240 VAC/DC _____ 787 532 ▶ 30 s selectable, 24 ... 240 VAC/DC _____ 787 530 ▶ Others available on request	▶ 3 s selectable, 24 ... 240 VAC/DC _____ 777 532 ▶ 30 s selectable, 24 ... 240 VAC/DC _____ 777 530 ▶ Others available on request
DC1: 24 V/8 A/200 W	CE, cULus Listed, EAC (Eurasia), TÜV, CCC	788 010	778 010
DC1: 24 V/5 A/125 W	CE, cULus Listed, EAC (Eurasia), BG, CCC	▶ 24 VDC _____ 787 340 ▶ Others available on request	▶ 24 VDC _____ 777 340 ▶ Others available on request
DC1: 24 V/5 A/125 W	CE, cULus Listed, EAC (Eurasia), BG, KOSHA, CCC	▶ 24 VAC _____ 787 354 ▶ 24 VDC _____ 787 355	▶ 24 VAC _____ 777 354 ▶ 24 VDC _____ 777 355
DC1: 24 V/6 A/150 W	CE, cULus Listed, EAC (Eurasia), TÜV, CCC	▶ U <sub>M</sub> : 0.5 V _____ 787 949 ▶ U <sub>M</sub> : 3 V _____ 787 950 ▶ U <sub>M</sub> : 0.0075 ... 0.5 V _____ 787 951	▶ U <sub>M</sub> : 0.5 V _____ 777 949 ▶ U <sub>M</sub> : 0.5 V, coated version _____ 777 959 ▶ U <sub>M</sub> : 3 V _____ 777 950 ▶ U <sub>M</sub> : 0.0075 ... 0.5 V _____ 777 951
DC1: 24 V/6 A/150 W	CE, cULus Listed, EAC (Eurasia), TÜV, CCC	787 585	777 585

Technical documentation on safety relays PNOZ X:

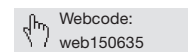

Online information at [www.pilz.com](http://www.pilz.com)

## ► Safety relay PNOZcompact

The safety relay is optimized for functionality and can be used in all areas of engineering. In series machine production in particular, the use of the PNOZcompact has many advantages thanks to its concentrated functionality: This allows high-volume projects with a high degree of standardization to be implemented economically. Choose a PNOZ safety relay – the original and a byword for safety relays.



PNOZ c1

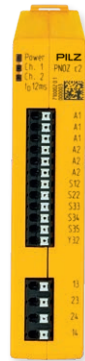

PNOZ c2

### Square, simple, yellow

You want to safely monitor an E-STOP device, safety gate or light beam device? Is it important to you to save time through simple installation and maintenance? Then we have the right solution for you – the safety relay PNOZcompact.

PNOZ c1 is ideal for monitoring E-STOP devices or safety gates. A block diagram with connection example is printed on the side of the unit and is a great help. PNOZ c2 is predestined for the safe monitoring of type 4 light beam devices, e.g. PSENopt from Pilz, or sensors with OSSD outputs in accordance with EN 61496-1 with a guaranteed maximum reaction time of 12 ms. You save time through simple installation because the transmitter and receiver are supplied with voltage directly via the evaluation device.



### Safety relay PNOZcompact

#### Common features

- ▶ PL e of EN ISO 13849-1, Safety Integrity Level (SIL) CL 3 of EN/IEC 62061
- ▶ Supply voltage ( $U_B$ ): 24 VDC
- ▶ LEDs to display operating voltage and switch status
- ▶ Spring-loaded terminals fixed on the device

Type	Application area	Dimensions (H x W x D) in mm
PNOZ c1	E-STOP relay and safety gate monitor	105 <sup>1)</sup> x 22.5 x 100
PNOZ c2	For monitoring type 4 light beam devices or sensors with OSSD outputs in accordance with EN 61496-1	105 <sup>1)</sup> x 22.5 x 100

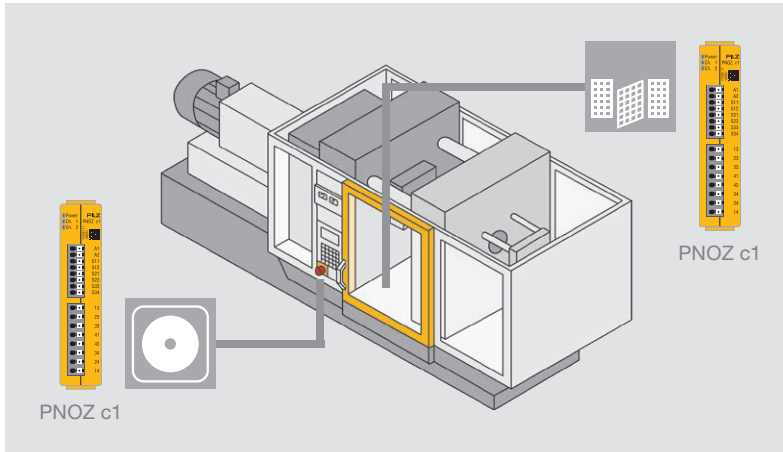

Monitor an E-STOP device or safety gate – in any application – safe, simple, compact. Use one safety relay per safety function.

**Your benefits at a glance**

- ▶ Save space in the control cabinet thanks to the compact design
- ▶ Simple installation and maintenance saves you time: push-in spring-loaded terminals fixed on the device, can be connected without the need for tools
- ▶ Tool-free assembly: simply attach the device to the top hat rail

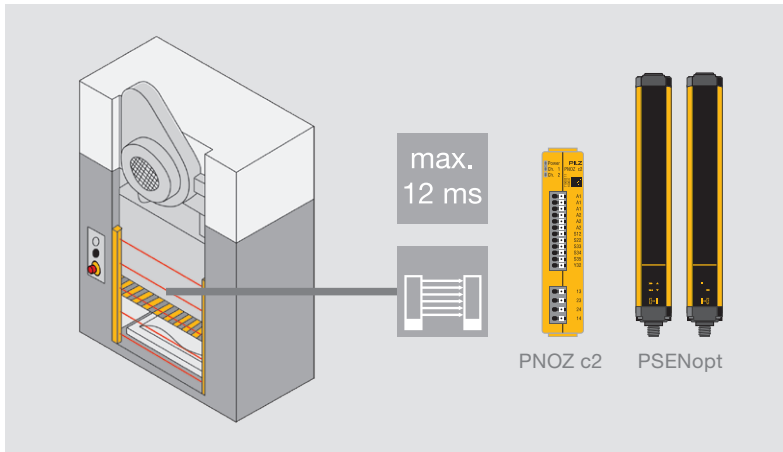

Monitor light beam devices, e.g. PSENopt from Pilz, or sensors with OSSD outputs safely, simply and in a compact form. All common light beam devices can also be connected.

Keep up-to-date on safety relays PNOZcompact:



Webcode: web150086

Online information at [www.pilz.com](http://www.pilz.com)

Features	Certification	Order number
<ul style="list-style-type: none"> <li>▶ 3 safety contacts/1 auxiliary contact (3 N/O/1 N/C)</li> <li>▶ 2-channel wiring with detection of shorts across contacts</li> <li>▶ Manual or automatic start</li> <li>▶ STOP category: 0</li> </ul>	CE, cULus Listed, EAC (Eurasian), TÜV, CCC	710001
<ul style="list-style-type: none"> <li>▶ 2 safety contacts (N/O)/1 semiconductor output</li> <li>▶ 2-channel wiring without detection of shorts across contacts</li> <li>▶ Monitored or automatic start</li> <li>▶ Guaranteed maximum reaction time: 12 ms</li> </ul>	CE, cULus Listed, EAC (Eurasian), TÜV, CCC	710002

<sup>1)</sup> Height incl. spring clip

## ► Safety relay PNOZelog

You can use the product group PNOZelog to monitor up to four safety functions. PNOZelog combines the experience from electromechanical safety relays with the benefits of modern electronics and is 100 % wear-free.



PNOZ e1.1p



PNOZ e6.1p

### Extended diagnostics, easy to link

Wear-resistance, safety, long service life and high availability ensure it is cost-effective to use. What's more, the PNOZelog can be linked simply through logic AND/OR operations. Diagnostics on the PNOZelog have been extended. Power-up tests, self-checking and runtime tests guarantee maximum safety.

### Complete safety functions through logic function operations

Units in the PNOZelog product range can be linked via logic operations to form complete safety functions. AND/OR operations are both available. The use of logic functions means that the output requires no additional wiring. As a result, both outputs on the PNOZelog units are freely available. As many units as necessary can be connected in series – ideal for monitoring up to four safety functions.



PNOZelog can be linked through logic AND/OR operations.

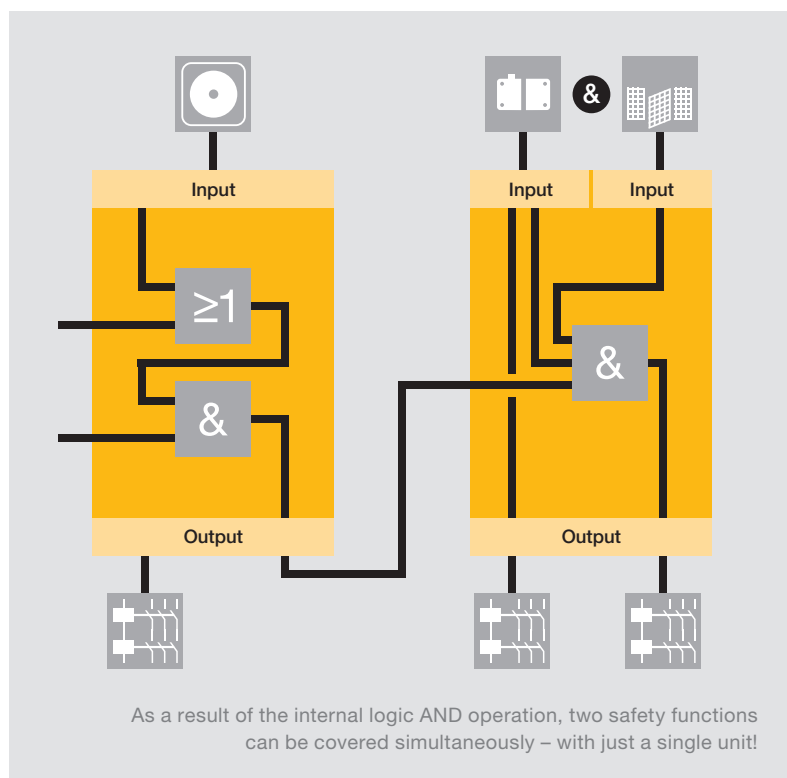

Less wiring due to linkable outputs.

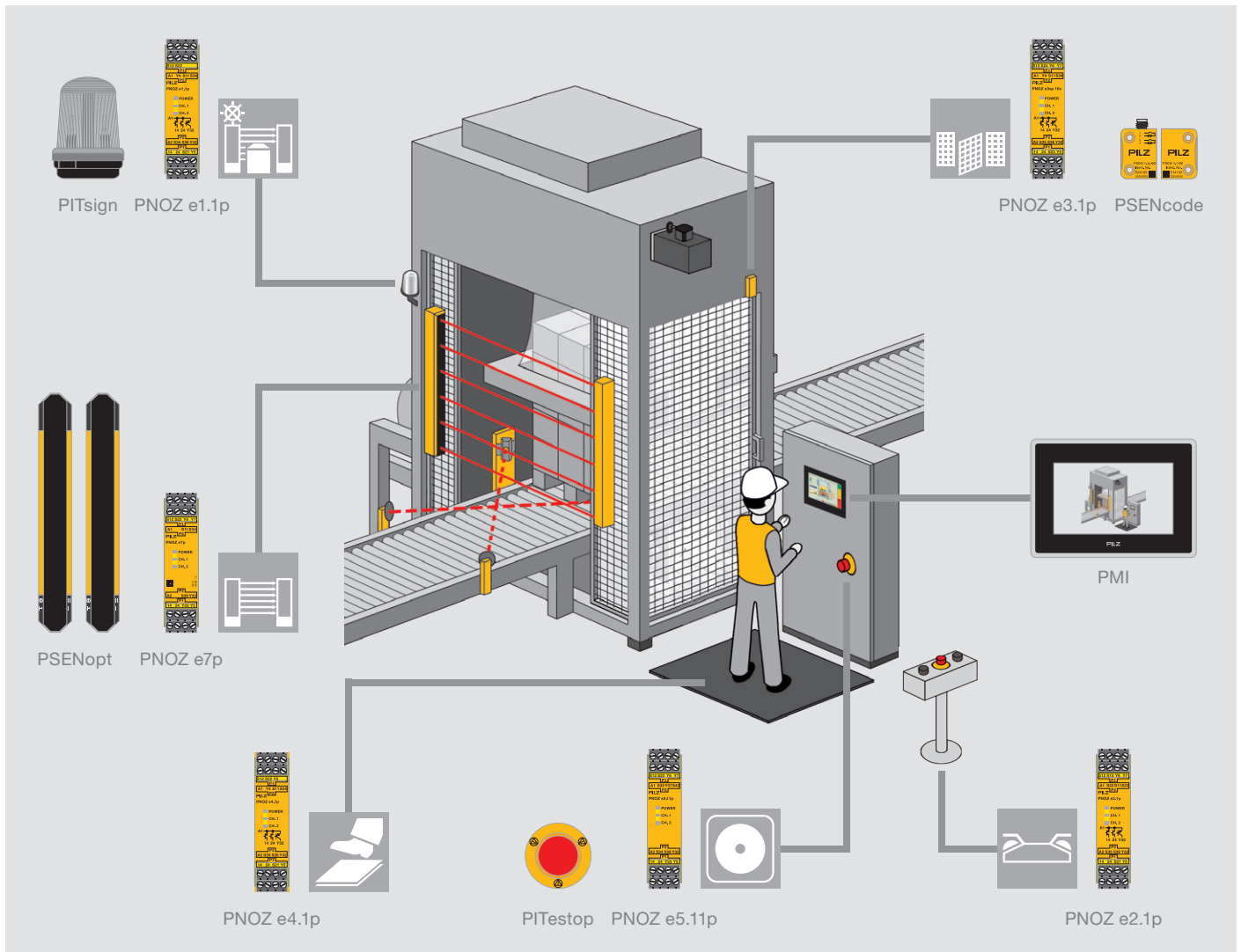

### Your benefits at a glance

- ▶ Less wiring thanks to simple logic operations (AND/OR)
- ▶ High availability thanks to extended diagnostics
- ▶ Consistent use of semiconductor technology means no maintenance is necessary – there are no malfunctions due to contact welding, contamination, bounce or burning
- ▶ Continuous self-checks provide the highest level of safety – fault detection is not linked to the on/off cycle
- ▶ Long service life, even with frequent operations or cyclical functions
- ▶ Safe switching operations even on the smallest of loads
- ▶ Rapid commissioning thanks to plug-in terminals; no additional tools are required
- ▶ Complete solution comprising evaluation devices, compatible sensor technology and control and signal devices

Keep up-to-date  
on safety relays  
PNOZelog:

 Webcode:  
web150101

Online information  
at [www.pilz.com](http://www.pilz.com)

## ► Selection guide – PNOZelog

### Safety relay PNOZelog



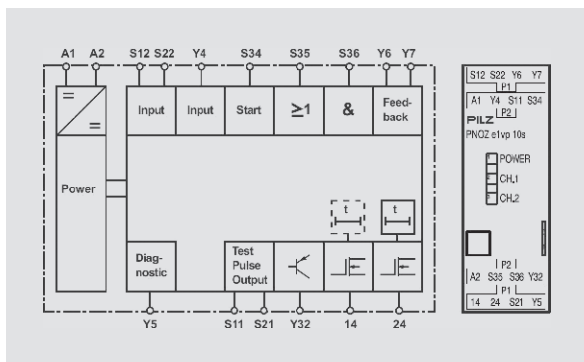



Type	Application					Performance Level (PL) – EN ISO 13849-1
PNOZ e1p	◆	◆	◆			e
PNOZ e1.1p	◆	◆	◆			e
PNOZ e1vp	◆	◆	◆			e
PNOZ e2.1p				◆	EN 574, Type IIIC	e
PNOZ e2.2p				◆	EN 574, Type IIIA	e
PNOZ e3.1p		◆				e
PNOZ e3vp		◆				e
PNOZ e4.1p					◆	d
PNOZ e4vp					◆	d
PNOZ e5.11p	◆	◆	◆			e
PNOZ e5.13p	◆	◆	◆			e
PNOZ e6.1p	◆	◆	◆			e
PNOZ e6vp	◆	◆	◆			e
PNOZ e7p			◆			e
PNOZ e8.1p with PLID d1	◆	◆	◆			d



Block diagram of PNOZ e1vp

#### Linking of multiple units using PNOZ e1vp as an example

The units of the PNOZelog product range can be logically linked to each other and to units of the PNOZmulti product range. On the PNOZelog, input S35 is intended for the logical OR operation and input S36 for the logical AND operation. Safety outputs 14 and 24 of the PNOZelog are suitable for logical operations.

Safety Integrity Level (SIL) CL claim limit in accordance with EN/IEC 62061	Semiconductor outputs		Relay outputs		Logic operations	
	Safe	Non-safe	Safe			
	 		 			
3	2	1	-	-		
3	2	1	-	-	♦	♦
3	2	1	-	-	♦	♦
3	2	1	-	-	♦	♦
1	2	1	-	-	♦	♦
3	2	1	-	-	♦	♦
3	2	1	-	-	♦	♦
2	2	1	-	-	♦	♦
2	2	1	-	-	♦	♦
3	2	2	-	-	♦ <sup>1)</sup>	
3	2	2	-	-	♦ <sup>1)</sup>	
3	2	1	4	-	♦	♦
3	2	1	4	-	♦	♦
3	2	1	-	-	♦	
2	2	2	-	-	♦	♦

<sup>1)</sup> Also AND-linked internally

Technical  
documentation  
on safety relays  
PNOZelog:

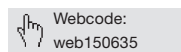

Online information  
at [www.pilz.com](http://www.pilz.com)

## ► Technical details – PNOZelog

### Safety relay PNOZelog



PNOZ e1.1p



PNOZ e2.1p



PNOZ e3.1p



PNOZ e4.1p

Type	Application area	Outputs	Outputs: Voltage/ current/ rating
<b>PNOZ e1p</b>	Emergency stop, safety gate and light beam monitoring	Using semiconductor technology: ▶ 2 safety outputs ▶ 1 auxiliary output, can be switched to a diagnostic output ▶ 2 pulsed outputs	24 VDC/ 2 A/50 W
<b>PNOZ e1.1p</b>	Emergency stop, safety gate and light beam monitoring	Using semiconductor technology: ▶ 2 safety outputs ▶ 1 auxiliary output, can be switched to a diagnostic output ▶ 2 pulsed outputs	24 VDC/ 2 A/50 W
<b>PNOZ e1vp</b>	Emergency stop, safety gate and light beam monitoring	Using semiconductor technology: ▶ 2 safety outputs delayed/ instantaneous, delay-on de-energization selectable ▶ 1 auxiliary output, can be switched to a diagnostic output ▶ 2 pulsed outputs	24 VDC/ 2 A/50 W
<b>PNOZ e2.1p</b> <b>PNOZ e2.2p</b>	PNOZ e2.1p: in accordance with EN 574, requirement class III C; PNOZ e2.2p: in accordance with EN 574, requirement class III A: two-hand monitoring	Using semiconductor technology: ▶ 2 safety outputs ▶ 1 auxiliary output, can be switched to a diagnostic output ▶ 2 pulsed outputs	24 VDC/ 2 A/50 W
<b>PNOZ e3.1p</b>	Safety gate monitoring	Using semiconductor technology: ▶ 2 safety outputs ▶ 1 auxiliary output, can be switched to a diagnostic output ▶ 2 pulsed outputs	24 VDC/ 2 A/50 W
<b>PNOZ e3vp</b>	Safety gate monitoring	Using semiconductor technology: ▶ 2 safety outputs delayed/ instantaneous, delay-on de-energization selectable ▶ 1 auxiliary output, can be switched to a diagnostic output ▶ 2 pulsed outputs	24 VDC/ 2 A/50 W
<b>PNOZ e4.1p</b>	Evaluation device for safety mats	Using semiconductor technology: ▶ 2 safety outputs ▶ 1 auxiliary output, can be switched to a diagnostic output ▶ 2 pulsed outputs	24 VDC/ 2 A/50 W
<b>PNOZ e4vp</b>	Evaluation device for safety mats	Using semiconductor technology: ▶ 2 safety outputs delayed/ instantaneous, delay-on de-energization selectable ▶ 1 auxiliary output, can be switched to a diagnostic output ▶ 2 pulsed outputs	24 VDC/ 1.5 A/40 W

#### Common features

- ▶ Supply voltage ( $U_B$ ): 24 VDC
- ▶ Dimensions (H x W x D) in mm: 101/94<sup>1)</sup> x 22.5 x 121



Features	Certification	Order number	
		Spring-loaded terminals	Plug-in screw terminals
<ul style="list-style-type: none"> <li>▶ Monitored or automatic start can be selected</li> <li>▶ Selectable monitoring of shorts across contacts</li> </ul>	CE, cULus Listed, EAC (Eurasian), TÜV, CCC	784 130	774 130
<ul style="list-style-type: none"> <li>▶ Monitored or automatic start can be selected</li> <li>▶ One AND and one OR input for logic AND/OR connections between several PNOZelog units</li> <li>▶ Selectable monitoring of shorts across contacts</li> </ul>	CE, cULus Listed, EAC (Eurasian), TÜV, CCC	784 133	774 133
<ul style="list-style-type: none"> <li>▶ Delay time selectable</li> <li>▶ Monitored or automatic start can be selected</li> <li>▶ One AND and one OR input for logic AND/OR connections between several PNOZelog units</li> <li>▶ Selectable monitoring of shorts across contacts</li> </ul>	CE, cULus Listed, EAC (Eurasian), TÜV, CCC	<ul style="list-style-type: none"> <li>▶ 10 s ____ 784 131</li> <li>▶ 300 s ____ 784 132</li> </ul>	<ul style="list-style-type: none"> <li>▶ 10 s ____ 774 131</li> <li>▶ 300 s ____ 774 132</li> </ul>
<ul style="list-style-type: none"> <li>▶ One AND and one OR input for logic AND/OR connections between several PNOZelog units</li> <li>▶ Shorts across contacts are monitored via two test pulse outputs</li> <li>▶ Status indicator</li> <li>▶ Feedback loop for monitoring external contactors</li> </ul>	CE, cULus Listed, EAC (Eurasian), TÜV, CCC	<ul style="list-style-type: none"> <li>▶ PNOZ e2.1p: 784 136</li> <li>▶ PNOZ e2.2p: 784 135</li> </ul>	<ul style="list-style-type: none"> <li>▶ PNOZ e2.1p: 774 136</li> <li>▶ PNOZ e2.2p: 774 135</li> </ul>
<ul style="list-style-type: none"> <li>▶ Evaluation device for safety sensors PSEN 2.1p-10 and PSEN 2.1p-11 and position switch with N/C / N/O combination</li> <li>▶ Monitored or automatic start can be selected</li> <li>▶ One AND and one OR input for logic AND/OR connections between several PNOZelog units</li> <li>▶ Selectable monitoring of shorts across contacts</li> </ul>	CE, cULus Listed, EAC (Eurasian), TÜV, CCC	784 139	774 139
<ul style="list-style-type: none"> <li>▶ Evaluation device for safety sensors PSEN 2.1p-10 and PSEN 2.1p-11 and position switch with N/C / N/O combination</li> <li>▶ Delay time selectable, either monitored or automatic start possible</li> <li>▶ One AND and one OR input for logic AND/OR connections between several PNOZelog units</li> <li>▶ Selectable monitoring of shorts across contacts</li> </ul>	CE, cULus Listed, EAC (Eurasian), TÜV, CCC	<ul style="list-style-type: none"> <li>▶ 10 s ____ 784 137</li> <li>▶ 300 s ____ 784 138</li> </ul>	<ul style="list-style-type: none"> <li>▶ 10 s ____ 774 137</li> <li>▶ 300 s ____ 774 138</li> </ul>
<ul style="list-style-type: none"> <li>▶ For connecting pressure-sensitive mats from Mayser (type SM/BK) and Bircher (type ESM5x)</li> <li>▶ One AND and one OR input for logic AND/OR connections between several PNOZelog units</li> </ul>	CE, cULus Listed, EAC (Eurasian), TÜV, CCC	784 180	774 180
<ul style="list-style-type: none"> <li>▶ For connecting pressure-sensitive mats from Mayser (type SM/BK) and Bircher (type ESM5x)</li> <li>▶ Delay time selectable</li> <li>▶ One AND and one OR input for logic AND/OR connections between several PNOZelog units</li> <li>▶ With or without reset function</li> </ul>	CE, cULus Listed, EAC (Eurasian), TÜV, CCC	10 s ____ 784 181	10 s ____ 774 181

Technical documentation on safety relays PNOZelog:

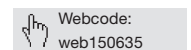

Webcode:  
web150635

Online information at [www.pilz.com](http://www.pilz.com)

<sup>1)</sup> Height incl. spring-loaded terminals/plug-in screw terminals

## ► Technical details – PNOZelog

### Safety relay PNOZelog



PNOZ e5.11p



PNOZ e5.13p



PNOZ e6.1p



PNOZ e7p

Type	Application area	Outputs	Outputs: Voltage/ current/rating
<b>PNOZ e5.11p</b>	Combination unit for monitoring 2 safety functions, AND-linked internally, AND input for logical connection of multiple units	Using semiconductor technology: ▶ 2 safety outputs ▶ 2 auxiliary outputs	24 VDC/ 1.5 A/40 W
<b>PNOZ e5.13p</b>	Combination unit for monitoring 2 safety functions, AND-linked internally, AND input for logical connection of multiple units	Using semiconductor technology: ▶ 2 safety outputs ▶ 2 auxiliary outputs	24 VDC/ 1.5 A/40 W
<b>PNOZ e6.1p</b>	Emergency stop, safety gate and light beam monitoring	Using semiconductor technology: ▶ 2 safety outputs ▶ 1 auxiliary output, can be switched to a diagnostic output ▶ 2 pulsed outputs Relay outputs: ▶ 4 safety contacts (N/O)	Outputs using semiconductor technology: 24 VDC/4 A/50 W Relay outputs: DC1: 24 V/6 A/150 W
<b>PNOZ e6vp</b>	Emergency stop, safety gate and light beam monitoring	Using semiconductor technology: ▶ 2 safety outputs delayed/instantaneous, delay-on de-energization selectable ▶ 1 auxiliary output, can be switched to a diagnostic output ▶ 2 pulsed outputs Relay outputs: ▶ 4 safety contacts (N/O)	Outputs using semiconductor technology: 24 V/4 A/50 W Relay outputs: DC1: 24 V/6 A/150 W
<b>PNOZ e7p</b>	Safety light beam devices, start buttons	Using semiconductor technology: ▶ 2 safety outputs ▶ 2 pulsed outputs ▶ 1 auxiliary output	24 VDC/ 1.5 A/40 W
<b>PNOZ e8.1p</b>	Evaluation device for safe line monitoring with PLID d1	Using semiconductor technology: ▶ 2 safety outputs ▶ 2 auxiliary outputs	24 VDC/ 1.5 A/40 W

#### Common features

- ▶ Supply voltage ( $U_B$ ): 24 VDC
- ▶ Dimensions (H x W x D) in mm: 101/94<sup>1)</sup> x 22.5 x 121,  
PNOZ e6.1p and PNOZ e6vp: 101/94<sup>1)</sup> x 45 x 121 mm

Features	Certification	Order number	
		Spring-loaded terminals	Plug-in screw terminals
<ul style="list-style-type: none"> <li>▶ Connection possibilities for E-STOP pushbuttons, safety gate limit switches, start buttons, proximity switches, position switches with N/C / N/C combination</li> <li>▶ For processing signals from output switching elements of light grids (OSSDs)</li> <li>▶ Monitored or automatic start can be selected</li> </ul>	CE, cULus Listed, EAC (Eurasian), TÜV, CCC	784 190	774 190
<ul style="list-style-type: none"> <li>▶ Connection possibilities for E-STOP pushbuttons, safety gate limit switches, start buttons, proximity switches, PSEN 2.x safety sensors, position switches with N/C / N/C or N/C / N/O combination</li> <li>▶ For processing signals from output switching elements of light grids (OSSDs)</li> <li>▶ Monitored or automatic start can be selected</li> </ul>	CE, cULus Listed, EAC (Eurasian), TÜV, CCC	784 191	774 191
<ul style="list-style-type: none"> <li>▶ Connection possibilities for E-STOP pushbuttons, safety gate limit switches, start buttons, proximity switches</li> <li>▶ For processing signals from output switching elements of light grids (OSSDs)</li> <li>▶ Monitored or automatic start can be selected</li> <li>▶ One AND and one OR input for logic AND/OR connections between several PNOZelog units</li> <li>▶ Selectable monitoring of shorts across contacts</li> </ul>	CE, cULus Listed, EAC (Eurasian), TÜV, CCC	784 192	774 192
<ul style="list-style-type: none"> <li>▶ Connection possibilities for E-STOP pushbuttons, safety gate limit switches, start buttons, proximity switches</li> <li>▶ For processing signals from output switching elements of light grids (OSSDs)</li> <li>▶ Delay time selectable</li> <li>▶ Monitored or automatic start can be selected</li> <li>▶ One AND and one OR input for logic AND/OR connections between several PNOZelog units</li> <li>▶ Selectable monitoring of shorts across contacts</li> </ul>	CE, cULus Listed, EAC (Eurasian), TÜV, CCC	784 193	774 193
<ul style="list-style-type: none"> <li>▶ Connection possibilities for safety light beam devices PSEN op2S-1-1, PSEN op4S-1-1, PSEN op4S-1-2, start buttons</li> <li>▶ Two operating modes selectable</li> <li>▶ Monitored or automatic start can be selected</li> <li>▶ One linking input for logic AND connections between multiple units</li> </ul>	CE, cULus Listed, EAC (Eurasian), TÜV, CCC	784 197	774 197
<ul style="list-style-type: none"> <li>▶ Connection possibilities for PLID d1, E-STOP pushbuttons, safety gate limit switches, start buttons, proximity switches, position switches with N/C / N/C combination</li> <li>▶ For processing signals from output switching elements of light grids (OSSDs)</li> <li>▶ Monitored or automatic start can be selected</li> <li>▶ Monitoring of shorts across contacts can be selected for E-STOP application</li> </ul>	TÜV, UL/cUL, CCC	784 198	774 198

<sup>1)</sup> Height incl. spring-loaded terminals/plug-in screw terminals

Technical documentation on safety relays PNOZelog:

 Webcode: web150635

Online information at [www.pilz.com](http://www.pilz.com)

## ▶ Safe line inspection device PLIDdys – Safe power-

The safe line inspection device PLIDdys provides safe power-up on two-wire connections, ensuring maximum safety on long cable routes.

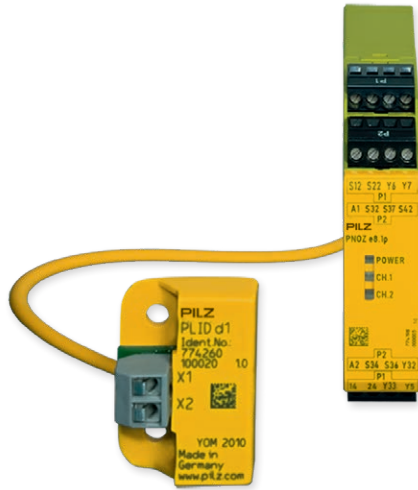

PLID d1 + PNOZ e8.1p

With PLIDdys, unintended power-up or plant start-up can be excluded in the event of an error. This is particularly beneficial on interlinked plants or on plant sections distributed over a wide area, which may not always be clearly visible. The extremely compact design means that PLIDdys can be easily retrofitted in an existing plant and incorporated in, for example, the sensor or switch. In combination with the evaluation device PNOZ e8.1p, the line inspection device PLIDdys is the optimum solution for safe cables/connections.



### Selection guide – Safe line inspection device PLIDdys



PLID d1 C

Type	Application area
PLID d1	Line inspection device PLIDdys in combination with the evaluation device PNOZ e8.1p
PNOZ e8.1p	Evaluation device for safe line monitoring with PLID d1

# up in conjunction with PNOZ e8.1p

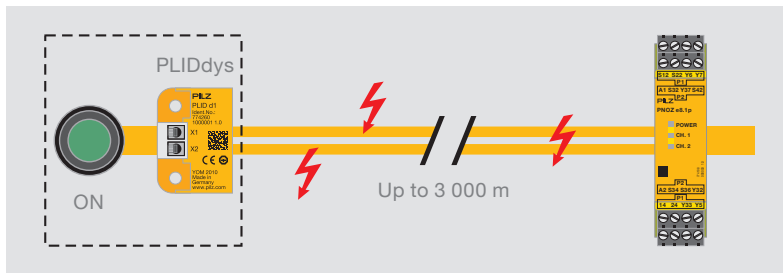

Monitoring for potential wiring errors and protection against power-up in the event of an error.

## Example applications of the line inspection device PLIDdys

Safe inspection of long cable routes in critical environments

- ▶ Cable cars, lift systems
- ▶ Wind turbines
- ▶ Conveyor belts in open cast mining or underground
- ▶ Tunnel boring machinery
- ▶ Press lines
- ▶ Fairground rides
- ▶ Drag chain applications
- ▶ Interlinked/distributed plant sections

## Your benefits at a glance

- ▶ All potential wiring errors are detected through constant line inspection by PLIDdys, no need for customized tests
- ▶ PLIDdys can be looped into the existing wiring, so few additional costs
- ▶ Easy to integrate into existing plants thanks to its small dimensions
- ▶ Saves costs, as the prevailing periphery can be retained
- ▶ Suitable for cable lengths up to 3 000 meters

Features	Certification	Order number
<ul style="list-style-type: none"> <li>▶ Cable cross section 0.5 mm<sup>2</sup> ... 1.5 mm<sup>2</sup></li> <li>▶ Maximum cable length 3 000 m</li> <li>▶ Cable resistance max. 220 Ω</li> <li>▶ Power supply 24 VDC</li> <li>▶ Weight 10 g</li> <li>▶ Temperature range -30 °C ... +70 °C</li> <li>▶ Dimensions (H x W x D) in mm: 36 x 26 x 12.1<sup>1)</sup></li> </ul>	TÜV, UL/cUL	<ul style="list-style-type: none"> <li>▶ PLID d1 C with spring-loaded terminals _____ 784 260</li> <li>▶ PLID d1 with plug-in screw terminals _____ 774 260</li> </ul>
<ul style="list-style-type: none"> <li>▶ Outputs using semiconductor technology:               <ul style="list-style-type: none"> <li>- 2 safety outputs</li> <li>- 2 auxiliary outputs</li> </ul> </li> <li>▶ Outputs: Voltage/current/rating: 24 VDC/1.5 A/40 W</li> <li>▶ Monitored or automatic start can be selected</li> <li>▶ Monitoring of shorts across contacts can be selected for E-STOP application</li> <li>▶ Dimensions (H x W x D) in mm: 101/94<sup>2)</sup> x 22.5 x 121</li> </ul>	TÜV, UL/cUL, CCC	<ul style="list-style-type: none"> <li>▶ PNOZ e8.1p C with spring-loaded terminals _____ 784 198</li> <li>▶ PNOZ e8.1p with plug-in screw terminals _____ 774 198</li> </ul>

Keep up-to-date on safe line inspection device PLIDdys:

Webcode:  
web150901

Online information at [www.pilz.com](http://www.pilz.com)

<sup>1)</sup> Depth incl. spring-loaded terminals/plug-in screw terminals

<sup>2)</sup> Height incl. spring-loaded terminals/plug-in screw terminals

## ► Safety relays PNOZpower

The safety relays PNOZpower are suitable for monitoring E-STOP devices, safety gates and light beam devices. PNOZpower can switch currents of up to 16 A AC/DC per contact. An overall breaking capacity of 40 A is available per module.

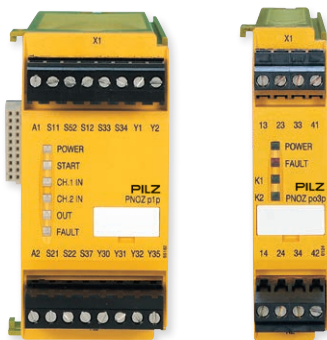

PNOZ p1p

PNOZ po3p

### Switching high loads safely

External contactors and contactor combinations are no longer required. The control circuit and main circuit are switched with one safety relay. The EC type examination is valid for the whole safety circuit.

### Modular and flexible

The base unit processes the inputs; the output modules are specifically matched to the respective load. The number and capacity of the required safety contacts can be scaled, depending on the application. A maximum of five modules can be connected to the base unit. Modules are wired to the base unit via an internal bus system.

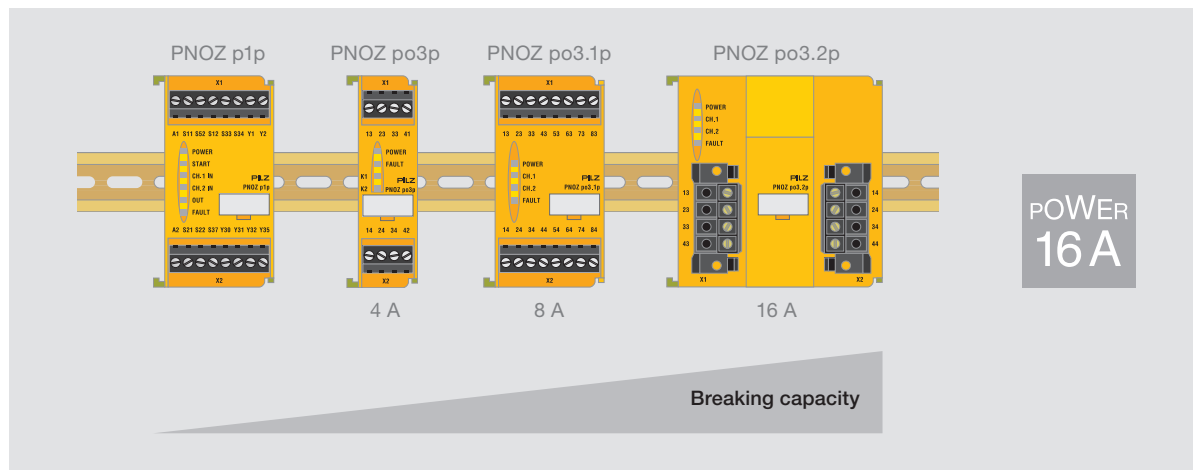
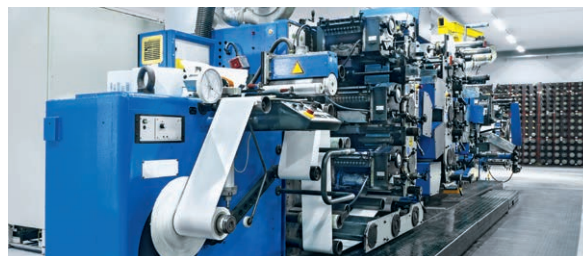

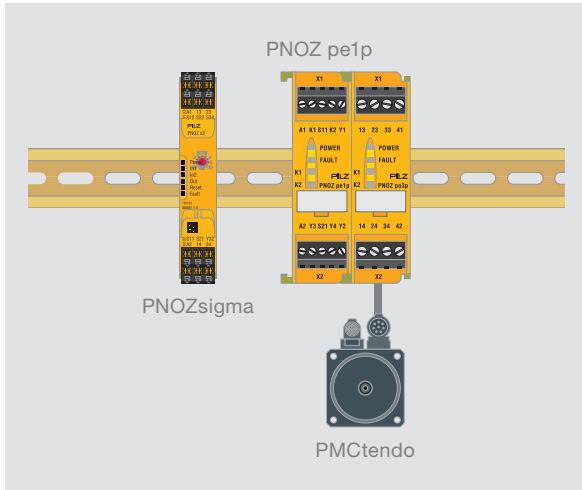

### Volt-free switching with the PNOZ pe1p control module

In conjunction with at least one expansion module from the PNOZpower range, the PNOZ pe1p control module safely shuts down motors or supply voltages on valves and contactors.

The PNOZ pe1p can be controlled using the following evaluation devices:

- ▶ Safety relays PNOZsigma, PNOZ X and PNOZelog
- ▶ Configurable small controllers PNOZmulti

The benefit to you: Potential-free switching up to 16 A.

### Your benefits at a glance

- ▶ External contactor combinations and their respective wiring are no longer required, saving costs, space and commissioning time
- ▶ Diagnostics via LED: operating and fault status is visible on each module, resulting in reduced downtimes
- ▶ Plug-in connection terminals: pre-wired and easy to exchange if there is a fault
- ▶ Redundant load switching
- ▶ Scalable and flexible by selecting compatible modules – you only pay for the functions that you actually use
- ▶ Complete solution comprising evaluation devices, compatible sensor technology and control and signal devices

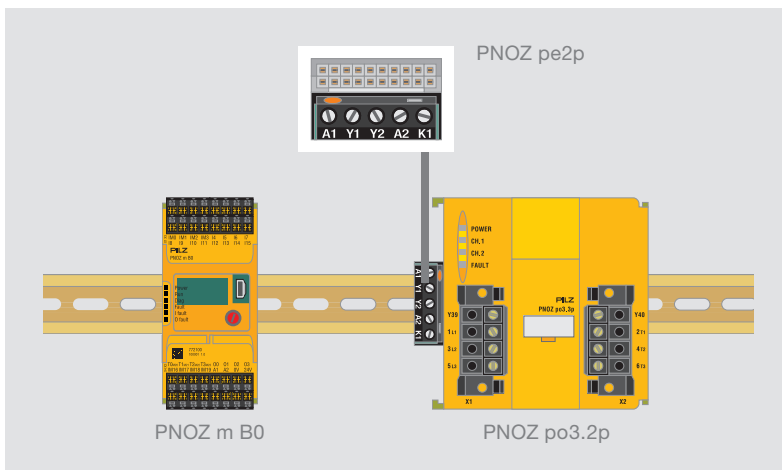

The PNOZpower safety relays and the PNOZmulti configurable small controllers can be combined simply using the coupling connector PNOZ pe2p.

### Connection to PNOZmulti

Specially developed for connection to the PNOZmulti configurable small controllers, PNOZpower units can be docked via the coupling connector PNOZ pe2p.





Keep up-to-date on safety relays PNOZpower:

Webcode: web150107

Online information at [www.pilz.com](http://www.pilz.com)

## ► Selection guide – PNOZpower

### Base units – Safety relays PNOZpower

Type	Application area	Application				Performance Level (PL) – EN ISO 13849-1
						
PNOZ p1p	Base unit	◆	◆	◆		e
PNOZ p1vp	Base unit, delayed	◆	◆	◆	◆	e (d) <sup>1)</sup>

### Contact expansion modules – Safety relays PNOZpower

Type	Output contacts		Performance Level (PL) – EN ISO 13849-1
	Safe 	Non-safe 	
PNOZ po3p	3	1	e
PNOZ po3.1p	8	-	e
PNOZ po3.2p	4	-	e
PNOZ po3.3p	3	-	e
PNOZ po4p	4	-	e

### Accessories – Safety relays PNOZpower

Type	Application area	Application	Performance Level (PL) – EN ISO 13849-1
PNOZ pe1p	Control module	For control via safety contacts or safe semiconductor outputs	e
PNOZ pe2p	Bus interface	Coupling connector for connecting PNOZpower expansion modules to a higher-level controller	e
PNOZ pps1p	Power supply	-	-



Safety Integrity Level (SIL) CL claim limit in accordance with EN/IEC 62061	Number of expansion modules	Supply voltage	Dimensions (H x W x D) in mm
3	Min. 1, max. 4 expansion modules	24 VDC	94 x 45 x 135
3	Min. 1, max. 8 expansion modules (max. 4 delayed and 4 instantaneous)	24 VDC	94 x 45 x 135

<sup>1)</sup> Value applies to instantaneous (delayed) safety contacts

Safety Integrity Level (SIL) CL claim limit in accordance with EN/IEC 62061	Number of expansion modules			Dimensions (H x W x D) in mm
	AC1	AC3	DC1	
3	240 V/4 A/960 VA	-	24 V/4 A/96 W	94 x 22.5 x 121
3	240 V/8 A/2 000 VA	-	24 V/8 A/200 W	94 x 45 x 121
3	240 V/16 A/4 000 VA	-	24 V/16 A/400 W	94 x 90 x 135
3	240 V/16 A/4 000 VA 400 V/10 A/4 000 VA 500 V/8 A/4 000 VA	240 V/3.0 kW 400 V/5.5 kW 500 V/4.0 kW	24 V/16 A/400 W	94 x 90 x 135
3	240 V/4 A/960 VA	-	24 V/4 A/96 W	94 x 22.5 x 121

Safety Integrity Level (SIL) CL claim limit in accordance with EN/IEC 62061	Number of expansion modules	Supply voltage	Dimensions (H x W x D) in mm
3	Min. 1, max. 4 expansion modules	24 VDC	94 x 22.5 x 121
3	Min. 1, max. 6 expansion modules	24 VDC	29 x 23.5 x 22
-	-	100 ... 240 VAC	94 x 45 x 121

Keep up-to-date on safety relays PNOZpower:

 Webcode: web150107

Online information at [www.pilz.com](http://www.pilz.com)

## ► Technical details – PNOZpower

### Safety relays PNOZpower



PNOZ p1p



PNOZ pe1p



PNOZ pe2p



PNOZ pps1p



PNOZ po3p



PNOZ po3.2p

Type	Application area	Inputs/outputs	Supply voltage
<b>PNOZ p1p</b>	Base unit	2 semiconductor outputs	24 VDC
<b>PNOZ p1vp</b>	Base unit, delayed	2 semiconductor outputs	24 VDC
<b>PNOZ pe1p</b>	Control module	Expansion module control output connected to the PNOZpower bus	24 VDC
<b>PNOZ pe2p</b>	Bus interface	Output connected to PNOZpower bus	24 VDC
<b>PNOZ pps1p</b>	Power supply	-	100 ... 240 VAC/DC
<b>PNOZ po3p</b> <b>PNOZ po4p</b>	Expansion modules	<ul style="list-style-type: none"> <li>► PNOZ po3p:               <ul style="list-style-type: none"> <li>- 3 safety contacts (N/O)</li> <li>- 1 auxiliary contact (N/C)</li> </ul> </li> <li>► PNOZ po4p:               <ul style="list-style-type: none"> <li>- 4 safety contacts (N/O)</li> </ul> </li> </ul>	Via PNOZpower bus
<b>PNOZ po3.1p</b>	Expansion module	8 safety contacts (N/O)	Via PNOZpower bus
<b>PNOZ po3.2p</b>	Expansion module	4 safety contacts (N/O)	Via PNOZpower bus
<b>PNOZ po3.3p</b>	Expansion module	3 safety contacts (N/O)	Via PNOZpower bus

Features	Certification	Order number  Plug-in screw terminals
<ul style="list-style-type: none"> <li>▶ Dual-channel wiring, with or without detection of shorts across contacts</li> <li>▶ Monitored or automatic start can be selected</li> <li>▶ Connection between PNOZ p1p and expansion modules via PNOZpower bus, using jumpers on the back of the unit</li> </ul>	CE, cULus Listed, EAC (Eurasian), TÜV, CCC	773 300
<ul style="list-style-type: none"> <li>▶ Dual-channel wiring, with or without detection of shorts across contacts</li> <li>▶ Monitored or automatic start can be selected</li> <li>▶ Delay time can be selected via rotary switch and potentiometer</li> <li>▶ Connection between PNOZ p1vp and expansion modules via PNOZpower bus, using jumpers on the back of the unit</li> </ul>	CE, cULus Listed, EAC (Eurasian), TÜV, CCC	<ul style="list-style-type: none"> <li>▶ 30 s ____ 773 950</li> <li>▶ 300 s ____ 773 951</li> </ul>
<ul style="list-style-type: none"> <li>▶ 1-channel operation, without detection of shorts across contacts</li> <li>▶ 2-channel operation, with or without detection of shorts across contacts</li> <li>▶ Connection between PNOZ pe1p and expansion modules via PNOZpower bus, using jumpers on the back of the unit</li> <li>▶ Status indicator for output relay, supply voltage and fault</li> <li>▶ Connection for feedback loop</li> </ul>	CE, cULus Listed, EAC (Eurasian), TÜV, CCC	773 900
<ul style="list-style-type: none"> <li>▶ Control via safety contacts or safe semiconductor outputs</li> <li>▶ 1-channel operation, without detection of shorts across contacts</li> <li>▶ Connection between PNOZ pe2p and expansion modules via PNOZpower bus</li> </ul>	CE, cULus Listed, EAC (Eurasian), TÜV, CCC	779 125
<ul style="list-style-type: none"> <li>▶ Galvanic isolation</li> <li>▶ Short-circuit-proof</li> <li>▶ 24 VDC at plug-in connector on back of unit for PNOZpower bus and at terminals</li> <li>▶ LEDs for supply voltage, output voltage and fault</li> </ul>	CE, cULus Listed, EAC (Eurasian), TÜV, CCC	773 200
<ul style="list-style-type: none"> <li>▶ 2-channel operation with the ability to detect short circuits via the base unit</li> <li>▶ LEDs for switch status of channels 1/2, supply voltage and fault</li> </ul>	CE, cULus Listed, EAC (Eurasian), TÜV, CCC	<ul style="list-style-type: none"> <li>▶ PNOZ po3p: 773 634</li> <li>▶ PNOZ po4p: 773 635</li> </ul>
	CE, cULus Listed, EAC (Eurasian), TÜV, CCC	773 630
	CE, cULus Listed, EAC (Eurasian), TÜV, CCC	773 631
<ul style="list-style-type: none"> <li>▶ 2-channel operation with the ability to detect short circuits via the base unit</li> <li>▶ LEDs for switch status of channels 1/2, supply voltage and fault</li> <li>▶ Suitable for safety-related switching of loads with utilization category AC3 (e.g. motor)</li> <li>▶ External start/stop input for non-safety-related load switching</li> </ul>	CE, cULus Listed, EAC (Eurasian), TÜV, CCC	773 632

Technical documentation on safety relays PNOZpower:

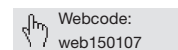

Webcode:  
web150107

Online information at [www.pilz.com](http://www.pilz.com)

## ► Safety Device Diagnostics

In combination with e.g. PNOZsigma or PNOZ X, Safety Device Diagnostics (SDD) provides simple and extensive diagnosis of safety devices. The signal I/Os of the safety devices, such as PSENcode, have their functions extended. Status information is interrogated, configuration parameters read and actions performed. Safety Device Diagnostics is the ideal solution for your application as it provides you with an overview of the safety devices at all times and from any location.

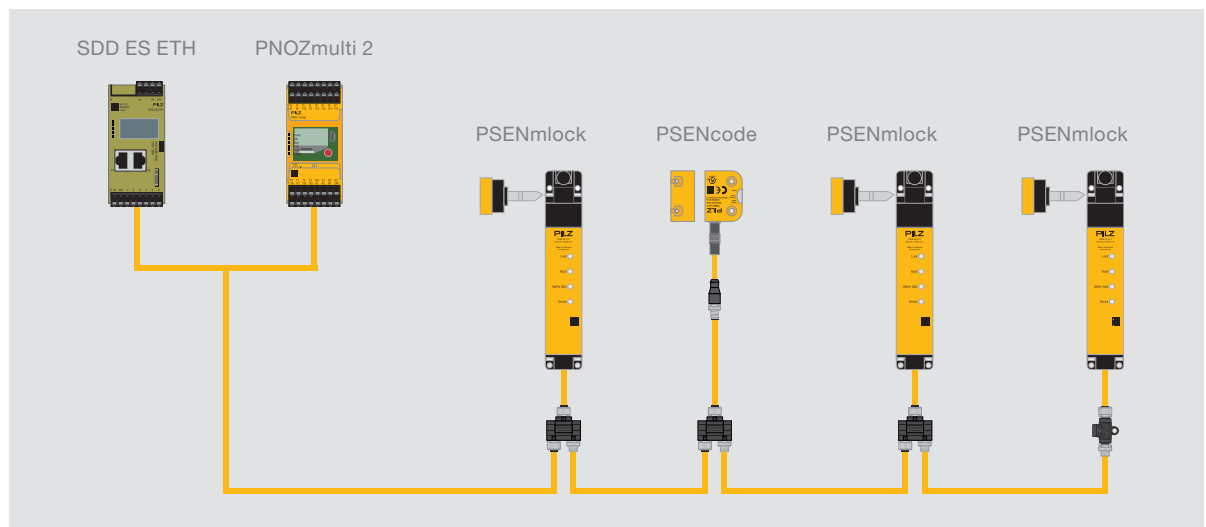

### Fewer service calls, greater availability

The availability of plant and machinery is also determined by safety devices. The extended diagnostic possibilities of Pilz safety devices with Safety Device Diagnostics can reduce service calls to your customers. End users benefit from a higher machine availability thanks to faster fault diagnostics. Safety Device Diagnostics can also provide an interface to the plant bus for all safety devices. Thanks to its expandability, Safety Device Diagnostics supports a modular machine structure within the framework of Industrie 4.0.

### Complete solution for extended diagnostics

Safety Device Diagnostics consists of a fieldbus module plus junction box and safety devices (e.g. sensors) and, in combination with e.g. PNOZsigma or PNOZ X, offers a cost-effective complete solution. The safety devices are automatically activated by the fieldbus module so that the signal contacts for the Safety Device Diagnostics are enabled. For example, a simple series connection of sensors in the field and remote maintenance via web server are possible. The solution using Safety Device Diagnostics therefore provides many more advantages than a conventional wiring of signal contacts. You decide which solution is optimum for your needs: the sensor remains the same.

### Type code for Safety Device Diagnostics

#### SDD ES ETH

Product area	Version
Safety Device Diagnostics	
Product group	<b>ETH</b> <b>Communication module with ETH interface</b>
<b>SDD ES</b> – Safety Device Diagnostics	PROFIBUS      Communication module with PROFIBUS interface
Electronic module <b>Standard</b>	PROFINET      Communication module with PROFINET interface
	EIP              Communication module with EtherNet/IP interface

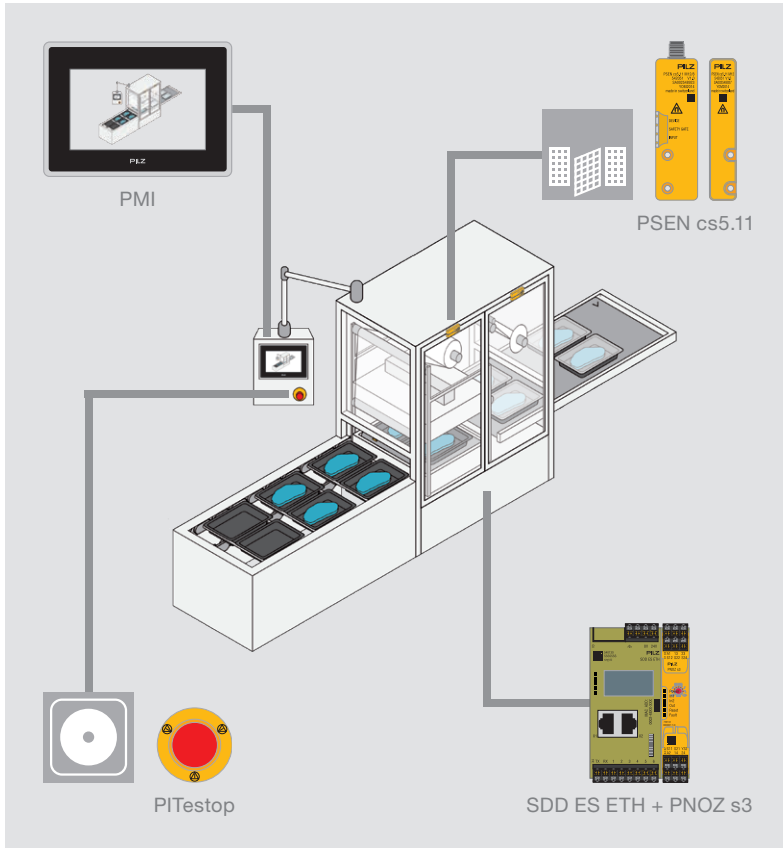

**Your benefits at a glance**

- ▶ Comprehensive diagnostics for reducing down times and number of service calls
- ▶ Simple diagnostics thanks to use of the same sensors and optional IP67 cabling
- ▶ Information is received directly via the display on the fieldbus module
- ▶ Targeted activation of individual sensors in the chain
- ▶ Quick and easy installation due to series connection in the field
- ▶ Third-party devices can be connected directly via the I/Os on the fieldbus module
- ▶ Cost-effective complete solution, e.g. with PNOZ X, PNOZsigma, PNOZmulti 2 or PSS 4000



Components for your safe solution	Order number
Sensor: PSEN cs5.11	542 011
Connection: PSEN cable, M12, 8-pin, 5 m distributor IP20	540 320 535 112
Evaluation device: PNOZ s3	751 103
Fieldbus module: SDD ES ETH	540 130
- spring-loaded terminals	540 121
- plug-in screw terminals	540 120

The coded safety switches PSENcode, which are often connected in series, are ideal here; see PSENcode slimline design.



Keep up-to-date on Safety Device Diagnostics:

Webcode: web150456

Online information at [www.pilz.com](http://www.pilz.com)

## ► Technical details – Safety Device Diagnostics

### Safety Device Diagnostics

#### Common features

- ▶ System consisting of fieldbus module, junction and safety devices (e.g. PSENcode, PSENmlock)
- ▶ Safety devices activated automatically via the fieldbus module
- ▶ Suitable for 16 sensors wired in series or individually wired
- ▶ 6 additional configurable I/Os
- ▶ Cable lengths:
  - Overall max. 900 m
  - Device 1 to device 2: 50 m
  - Last device to communication module: 150 m
- ▶ Reaction times (not safety-related):
  - Safety-related data: see individual relay
  - Diagnostic data: < 2 seconds



SDD ES ETH

#### Type

SDD ES ETH

SDD ES PROFIBUS

SDD ES PROFINET

SDD ES EIP

SDD ES Set Screw Terminals

SDD ES Set Spring Loaded Terminals

PSEN Y junction M8-M12/M12 PIGTAIL

PSEN Y junction M12-M12/M12 PIGTAIL

PSEN Y junction M12 SENSOR

PSEN Y junction M12 cable

PSEN Y junction M8 SENSOR

PSEN Y junction M8 cable

PSEN ix2 F4 code

PSEN ix2 F8 code

SDD ES ETH Starter-Set I

Features	Certification	Order number
Communication module with ETH connection	CE, cULus Listed	540 130
Communication module with PROFIBUS connection	CE, cULus Listed	540 132
Communication module with PROFINET connection	CE, cULus Listed	540 138
Communication module with EtherNet/IP connection	CE, cULus Listed	540 137
Plug-in screw terminals	-	540 120
Spring-loaded terminals	-	540 121
Junction with pigtail IP67 for one sensor	-	540 337
Junction with pigtail IP67 for one sensor	-	540 338
Junction without pigtail IP67 for one sensor	-	540 315
Junction without pigtail IP67 for one sensor	-	540 316
Junction without pigtail IP67 for one sensor	-	540 317
Junction without pigtail IP67 for one sensor	-	540 318
Distributor IP20 for up to four sensors	UL/cUL	535 111
Distributor IP20 for up to eight sensors	UL/cUL	535 112
<ul style="list-style-type: none"> <li>▶ Communication module with ETH connection</li> <li>▶ Two PSENcode sensors</li> <li>▶ Junction box</li> <li>▶ PSEN cable</li> <li>▶ Ethernet cable</li> <li>▶ Power supply</li> <li>▶ Spring-loaded terminals</li> </ul>	-	540 110

Technical documents for Safety Device Diagnostics:

 Webcode: web150635

Online information at [www.pilz.com](http://www.pilz.com)



## ▶ Configurable safe small controllers

Users worldwide trust the market leader in configurable safety controllers. PNOZmulti stands for safety and simple integration in production processes. By using PNOZmulti for the monitoring of your safety functions, you can increase the productivity of your plant and machinery. As a manufacturer, you benefit from short engineering times: just one software tool from planning to maintenance and easy commissioning. PNOZmulti offers the right solution for all of your automation tasks and is as easy to use as a safety relay, but as flexible as a programmable controller.

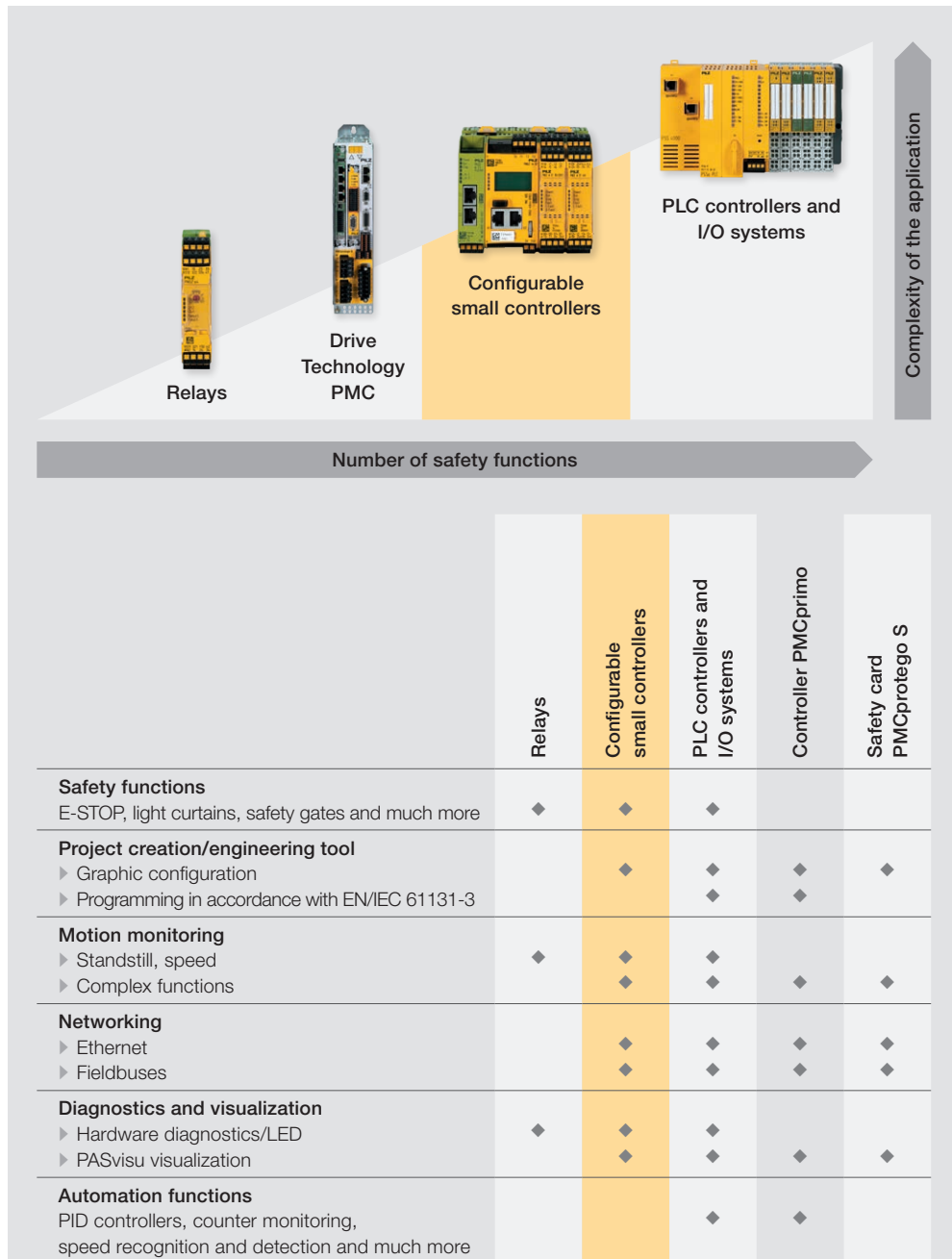





## Product area

### Configurable safe small controllers

- ▶ Configurable safe small controllers PNOZmulti 2 66
- ▶ Software tools PNOZmulti Configurator,  
diagnostic solution PVIS 96
- ▶ Accessories PNOZmulti 98
- ▶ Decentralized modules PDP67 100
- ▶ Cable navigator 102

## ► Configurable safe small controllers PNOZmulti 2



Count on the bestseller and the worldwide safety standard for all machine types. The small controllers PNOZmulti have proven themselves in hundreds and thousands of applications when it comes to safeguarding plant and machinery. We continue to write our success story! The second generation of the small safety controllers offers you a modular structure for the hardware, tested software blocks and a high level of connectivity. User-friendly, web-based visualization and simple diagnostics options reduce downtimes. Complete solutions with actuator technology, sensor technology and operator terminals together with the small controllers PNOZmulti 2 guarantee safe interaction between human and machine and economical safety solutions from a single source.

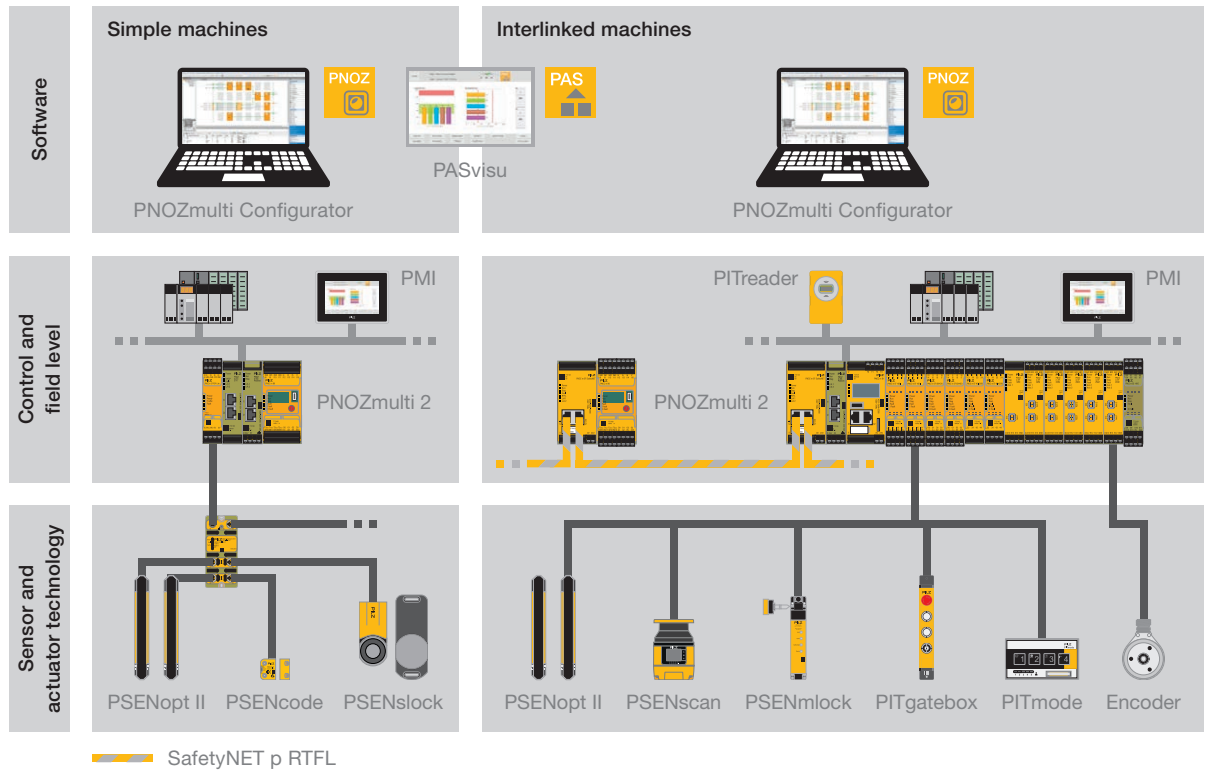

### Global safety standards – easy, fast, safe

The configurable safe small controllers PNOZmulti are suitable for both simple machines and large automation projects. A wide range of expansion modules, including for special applications, offer you the greatest flexibility in your application. You can use PNOZmulti as the standard for the monitoring of your safety functions independently of the higher-level operation control. The wide range of fieldbus and communications options results in high connectivity. Adaptation to the changing requirements of your application can be implemented quickly, easily and safely thanks

to the graphics-based software tool PNOZmulti Configurator. A coordinated complete solution for your automation tasks is available in combination with

- Safe sensor technology PSEN
- Operator terminals PIT
- Decentralized periphery PDP67
- Diagnostics and visualization panels PMIvisu
- Web-based visualization systems PASvisu
- Drive solution PMC

# - many functions, one solution!

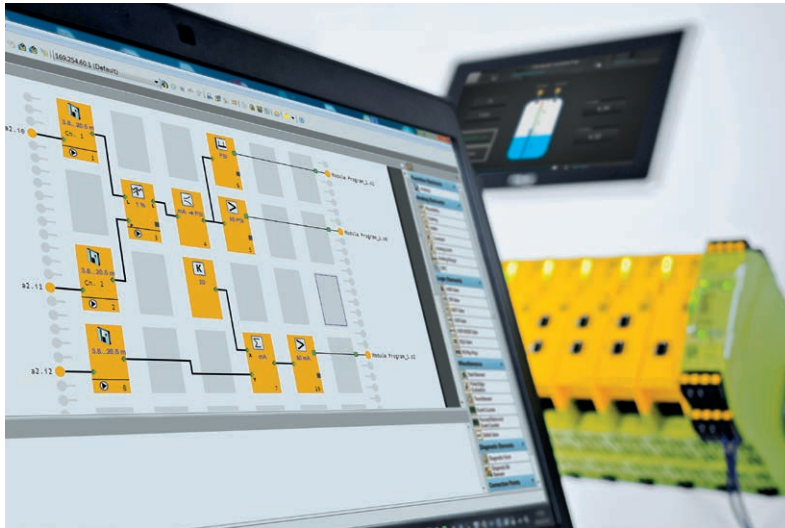

PNOZmulti has an intuitively operated software tool that enables graphic configuration of complex processes without programming knowledge.

## All for one and one for all

The software tool PNOZmulti Configurator will impress you with its simple operation: install, open, work intuitively. Furthermore, you have several options for carrying out your diagnostics – for high plant availability and minimal downtimes. The range of fieldbuses and communication possibilities are a major benefit of PNOZmulti. It allows the system to be used independently of the higher-level operation control system. A wide selection of expansion modules ensures maximum flexibility and safety for your application. Input and output modules, motion monitoring modules and link modules are available.

## Potential for rationalization: Safety components cover automation tasks

PNOZmulti is powerful enough to assume complete machine control on smaller machines. You can count on products of an extremely high quality. Moreover, as there is no need for an additional control system, PNOZmulti can make savings in a range of areas, from hardware costs and space in the control cabinet to procurement and stock holding costs.

## Your benefits at a glance

- ▶ Cost-effective and long-lasting: worldwide safety standard for many automation environments and communication systems
- ▶ Just one system from planning to maintenance
- ▶ Flexible: configuration using certified software blocks, simple adjustment and adaptation
- ▶ Customized costs: exact adaptation to your application using expansion modules
- ▶ Minimal machine downtimes and high plant availability through simple, user-friendly diagnostics
- ▶ Maximum safety – depending on the wiring, safety categories up to PL e and SIL CL 3
- ▶ Simple wiring means short commissioning times
- ▶ Potential for rationalization because safety components cover automation tasks
- ▶ Suitable for international use due to worldwide certification
- ▶ User-friendly thanks to technical support

Keep up-to-date on configurable safe small controllers PNOZmulti:

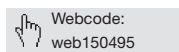

Online information at [www.pilz.com](http://www.pilz.com)



## ► Configuration software PNOZmulti Configurator



PNOZmulti small controllers make design, configuration, documentation and commissioning simple. Easy diagnostic solutions reduce downtimes on your plant or machinery. Our user-friendly software tools are available to do this. With the PNOZmulti Configurator, you can create your safety circuit on the PC. The software has a broad function and command range so that even large-scale projects can be easily implemented. For user-friendly diagnostics, you can use the tools of the diagnostic solution PVIS. You can keep a close eye on your automation system using the web-based visualization software PASvisu.

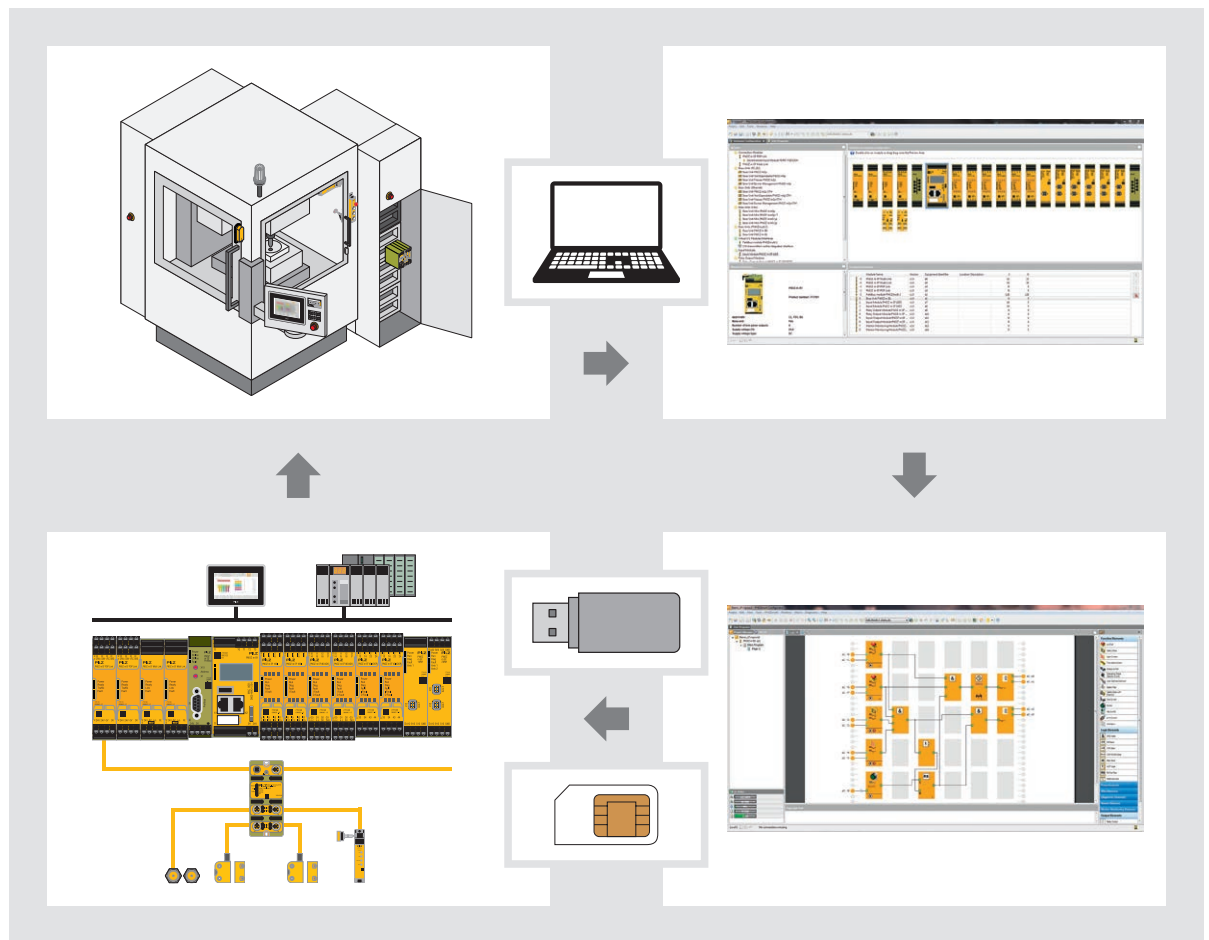

From your application to the solution with PNOZmulti. Configure the hardware and the safety circuit using the convenient software tool PNOZmulti Configurator. This shortens your time-to-market and allows you to harness great cost-saving potential in all engineering phases – from planning all the way to maintenance!

# - all-in-one

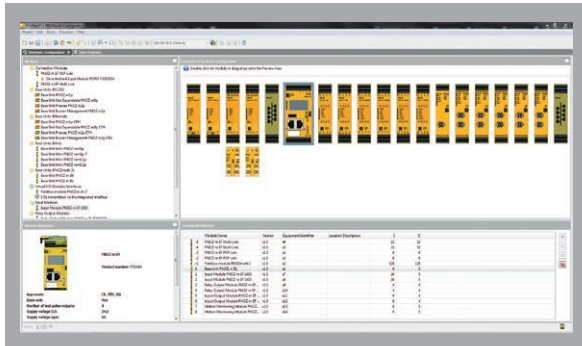

Simple hardware configuration by means of drag&drop.

## Versatile – without programming knowledge

First select the necessary hardware by drag & drop. The hardware consists of a base unit and, if necessary, expansion modules. The number of available inputs and outputs is displayed in table form. The software tool provides support, for example, by listing the expansion modules available for the selected base unit. The tool can also help if the permitted number of expansion modules has been exceeded or if the modules have been positioned incorrectly.

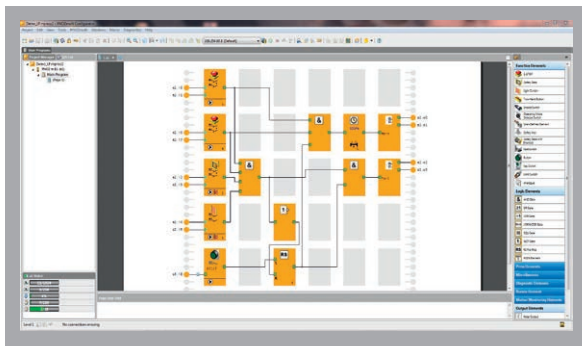

Simple application creation, linking using the mouse.

## Mouse used for wiring

All elements of a safety circuit are available to you on the Windows® standard graphics-based user interface as function blocks for input elements such as emergency stop, safety gates, light curtains, analog measurement values. Relays, semiconductors or safety valves can be selected as output elements. Special applications such as burners, motion monitoring, presses, authorization, operating mode selection and more can also be conveniently drawn to the user interface, configured for the specific application and linked using logic elements. Comprehensive diagnostic options increase the plant availability and reduce downtimes.

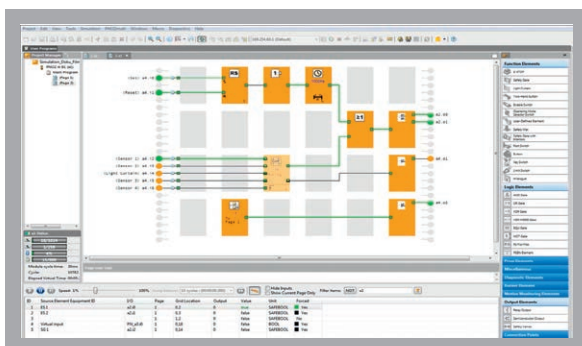

The state of the inputs and outputs of the configured elements and the connections between the elements are displayed.

## Error-free through offline simulation

From version 10.9 onwards you can already test your configured user program without the need for hardware by using the Simulation function before commissioning. Simulation opens up considerable savings potential in project planning through the verification of complex logic at the click of a mouse. Simulation helps to reduce risks for human and machine and to lower installation costs.

Video tutorials – we provide a video tutorial on our website for every new release.

Online information at [www.pilz.com/pnozmulti-tools](http://www.pilz.com/pnozmulti-tools)

## ▶ Optimum visualization and simple diagnostics



The configurable safe small controllers PNOZmulti provide you with many options for performing diagnostics: for high plant availability and minimal downtimes. In the software tool PNOZmulti Configurator the diagnostic solution PVIS is only a click away. Or you can rely on our operator terminals PMIvisu with the preinstalled visualization software PASvisu. You can send status messages to the connected PLC controller via the interfaces Ethernet TCP/IP or Modbus TCP or using the fieldbus module. PNOZmulti units can be connected to all common communication networks.

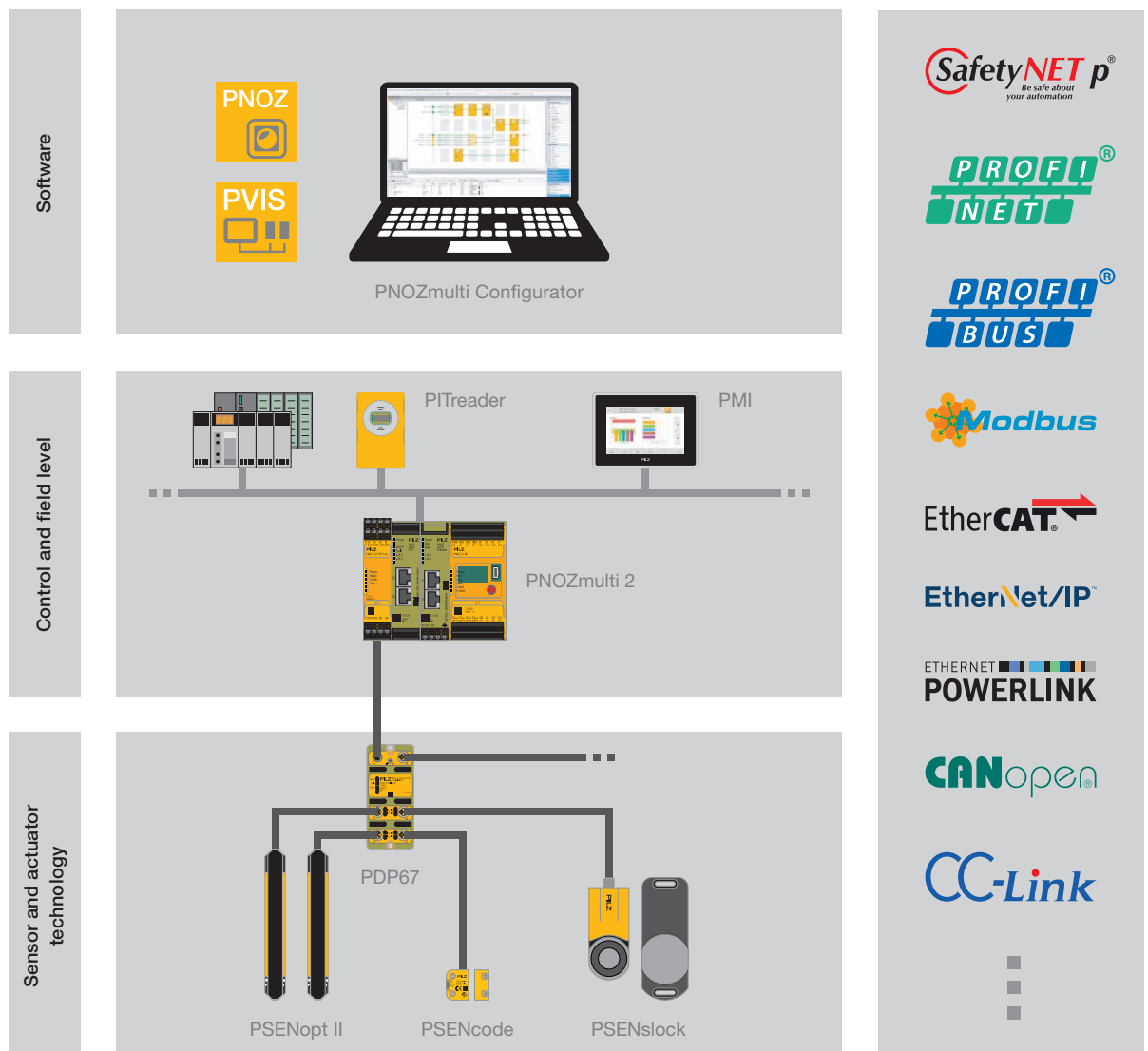

Small controllers PNOZmulti 2 – complete solutions in combination with the web-based visualization software PASvisu, the operator terminals PMI, the access permission PITreader, the safe sensor technology PSEN and the decentralized periphery PDP67!

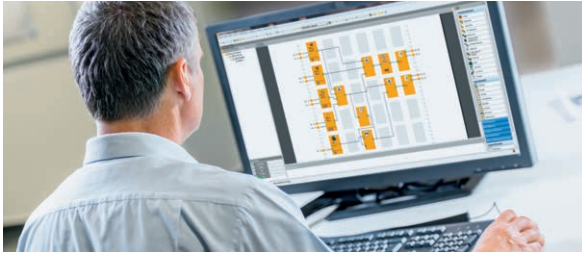

### Reducing downtimes using the diagnostic solution PVIS

Reliable and easy diagnostics are a prerequisite for enabling plant and machinery to manufacture efficiently, cost effectively and without interruption. With PVIS Pilz has developed a universal diagnostic solution for the entire range, from small machines to large plants. PVIS helps to visualize diagnostic information for PVIS-enabled controllers, such as small controllers PNOZmulti or drive technology PMC. Together with the PMI operator terminals, this provides you with a complete, fully integrated diagnostic solution. With the PVIS OPC and OPC UA tools, PVIS is available on the basis of standard software interfaces so that it can be integrated in almost any environment. The OPC UA standard is used for Smart Factory plants within the framework of Industrie 4.0. If a fault occurs, features such as plain text messages with precise information on the location, clearly defined responsibilities and integrated first fault display all ensure that production is quickly restarted. The PNOZmulti Configurator contains the PNOZmulti project, texts for diagnostics, proposed solutions and much more. The benefits are obvious: simpler project development, greater flexibility and reduction of downtimes.



Operator terminals PMIvisu with visualization software PASvisu.

### Connection of the configurable safe small controllers PNOZmulti to the visualization software PASvisu

Use perfectly matched software and the appropriate operator terminals to visualize your plant that uses the small controllers PNOZmulti.

#### Your benefits at a glance

- ▶ Saves time when troubleshooting and rectifying faults – the machine can be restarted quickly
- ▶ Using the plain text messages, machine operators immediately know which fault has occurred
- ▶ Active support for the operator in rectifying the fault with step-by-step instructions
- ▶ PVIS names the person responsible for rectifying the fault – e.g. a maintenance engineer
- ▶ Less time between machine standstill and starting up again

Keep up-to-date on the software tool “Diagnostic solution PVIS”:

Webcode:  
web150398

Online information at [www.pilz.com](http://www.pilz.com)

#### Your benefits at a glance

- ▶ Simple, intuitive handling and maximum suitability for use
- ▶ Use of current web technologies: HTML5, CSS3 and JavaScript
- ▶ Few downtimes thanks to remote access with genuine Client/Server functionality

Further information on PASvisu and PMIvisu can be found on pages 176 and 182.

## ► Configurable safe small controllers PNOZmulti 2



You can use the configurable safe small controllers PNOZmulti 2 for safety-related shutdown of plant and machinery safely and in compliance with the standards up to PL e of EN ISO 13849-1 and SIL CL 3 of EN/IEC 62061, irrespective of the machine type, plant type, country or industry. PNOZmulti 2 ensures a controlled and therefore safe stopping of a movement and is used for position monitoring or for interrupting a movement when the user intervenes.

### Independent and can be standardized

You create your safety architecture for the plant-dependent safety functions and independently of the higher-level plant control. Once user programs have been created, they can be flexibly adapted and reused again and again. This provides benefits in terms of time and cost savings that lower your engineering costs from project planning to maintenance.

### Modular and flexible

PNOZmulti 2 is a modular system and is comprised of a base unit plus expansion modules. The modular structure is as flexible as your application. Safe analog input modules, dual-pole output modules, motion monitoring modules and many more offer extensive possibilities for implementing state-of-the-art safety applications.



PNOZ m B1



PNOZ m B1 Burner



PNOZ m B0

### Base units PNOZmulti 2 – the basis for your application

The base units are only 45 mm wide and have an illuminated display.

- PNOZ m B1 – for large-scale projects. No inputs or outputs on the base unit, number of I/Os can be controlled via expansion modules. With 2 integrated ETH interfaces and Modbus/TCP on board
- PNOZ m B1 Burner – specifically for applications in industrial burner management
- PNOZ m B0 – the universal option. With on-board inputs and outputs

### Your benefits at a glance

- Certified hardware and software for reliable operation
- Easy to configure thanks to user-friendly software tools
- Short time-to-market as the inputs and outputs are freely configurable
- The appropriate modules for every requirement – flexible, simple, economical to expand
- Comprehensive diagnostic options mean short downtimes
- Fast commissioning thanks to simple wiring with plug-in terminals
- Maximum safety – up to PL e and SIL CL 3, depending on the application

Base units  
PNOZmulti 2:  
technical features  
from page 86

Webcode:  
web150382

Online information  
at [www.pilz.com](http://www.pilz.com)



# - the success story continues!

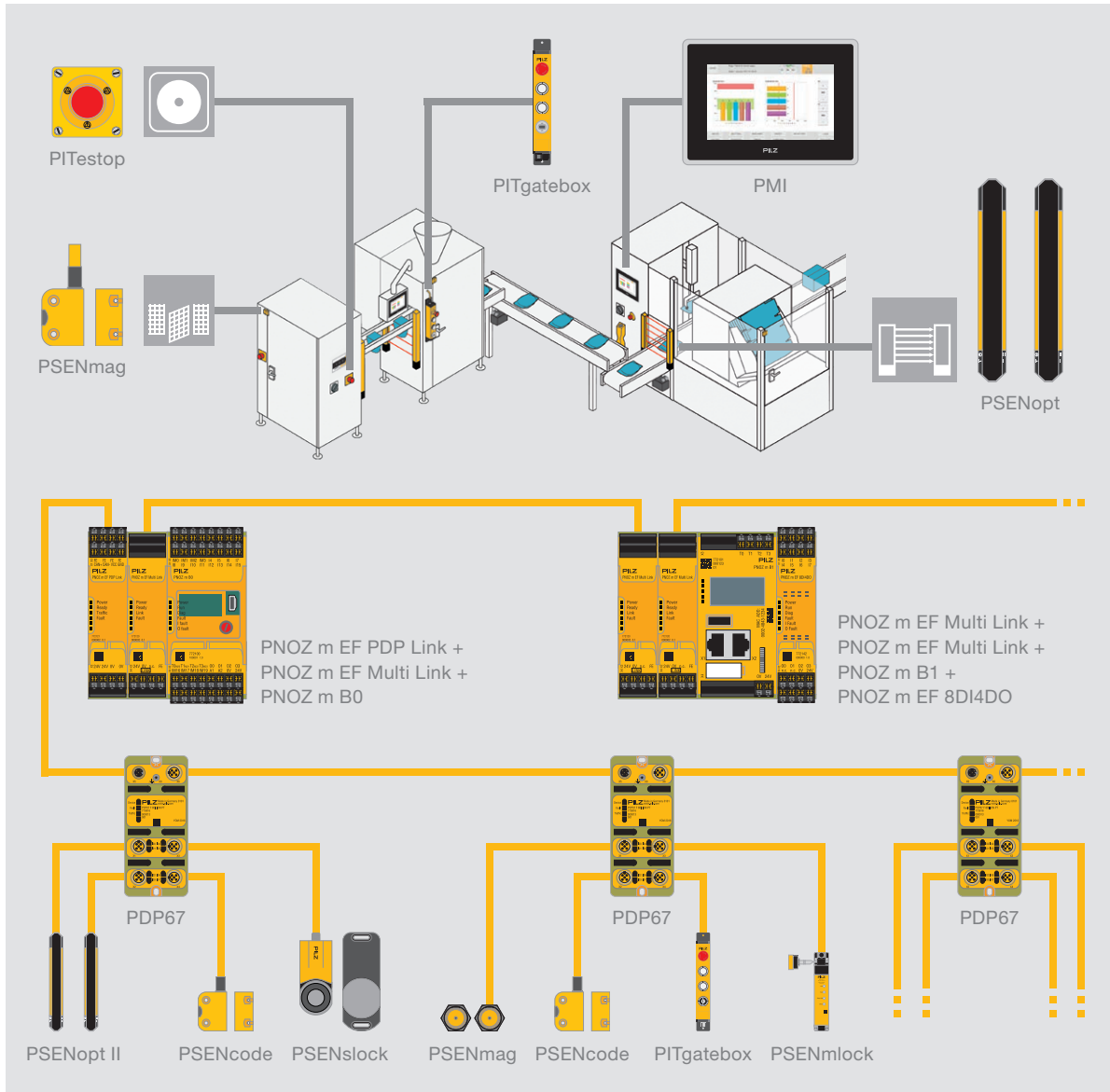

The decentralized modules PDP67 can be connected to the PNOZmulti 2 via a link module – for cost-effective, simple, decentralized expansion. Multi-link modules are also available for networking several base units.

## Decentrally in the field

The PDP link module serves as the interface for the decentralized modules PDP67 (to protection type IP67) to the base unit. The signals from the connected sensors are directly forwarded to the PDP link module from the field for further processing. With up to 16 PDP67 modules on one base unit, the number of sensors that can be connected increases by 64. This is what an economical solution looks like!

## Complex tasks – a team effort

The multi-link module enables simple, safe data exchange between several base units. Thanks to the modular structure of the PNOZmulti 2, different topologies can be implemented on one base unit with up to four link modules. As a result, users can connect several PNOZmulti units to implement safety functions for complex plant and machinery.

Keep up-to-date on configurable safe small controllers PNOZmulti 2:

 Webcode: web150500

Online information at [www.pilz.com](http://www.pilz.com)

## ▶ Safe communication via SafetyNET p RTFL

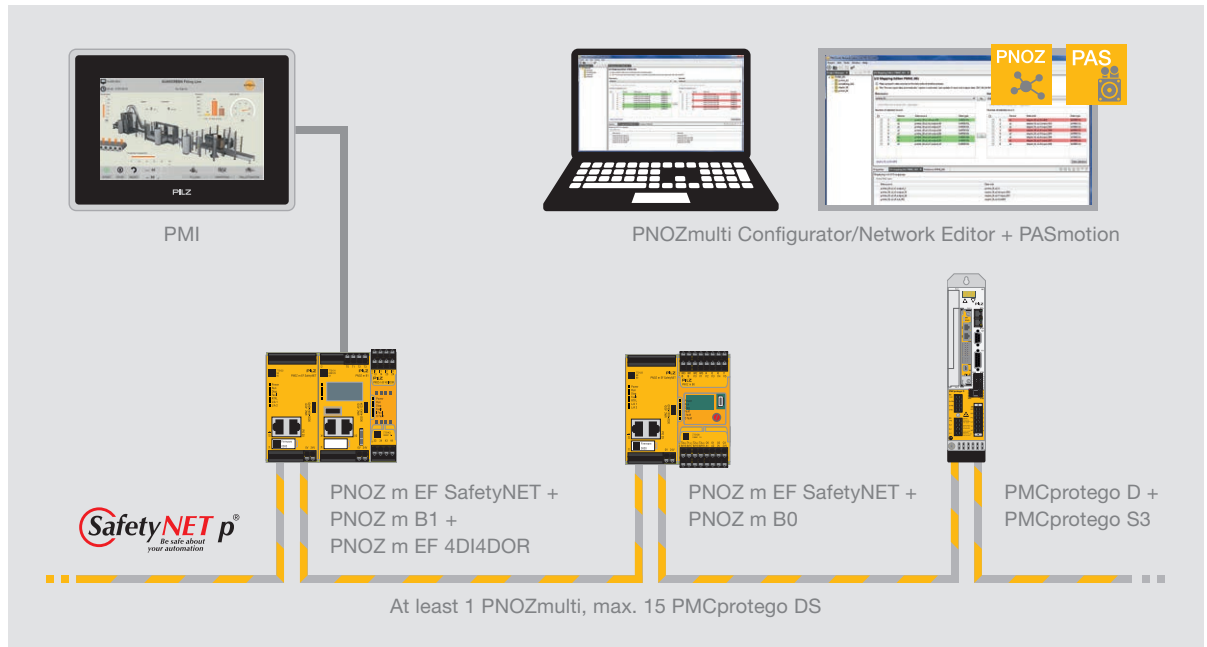

Safe communication via the real-time Ethernet SafetyNET p RTFL with PNOZmulti 2 and safe motion solution PMCprotego DS. This is also possible as a purely PNOZmulti 2 network with up to 16 subscribers.

### For complex plant and machinery

You can now link up to 16 base units via the safe real-time Ethernet SafetyNET p RTFL. Use the expansion module PNOZ m EF SafetyNET to achieve this. 32-bit data is exchanged via RTFL for short scan times in practice. A clearly structured data interface where the inputs are configured with 128 bit and the outputs with 32 bit characterizes the data link. PNOZmulti Network Editor is used for configuration of a SafetyNET p network and for project linking. It is called up directly from the PNOZmulti Configurator and can interlink variables of the input or output image of PNOZmulti projects. After upload into the PNOZmulti systems, the SafetyNET p network is ready to use.

### Safe drive solutions in the system

You can build the system out of only PNOZmulti 2 base units (PNOZ m B0 or B1) or integrate the safe motion solution PMCprotego DS in the SafetyNET p network. PMCprotego DS is composed of the servo amplifier PMCprotego D and the safety card PMCprotego S3. The end result is a safe drive solution in conjunction with PNOZmulti 2. This monitors the drive solution and ensures the movement is stopped in a controlled and therefore safe manner.

### Your benefits at a glance

- ▶ Safe communication via the real-time Ethernet SafetyNET p
- ▶ Fast RTFL communication with short scan times
- ▶ Up to 16 PNOZmulti systems in linear topology with easy networking with the PNOZmulti Network Editor
- ▶ Combination of PNOZmulti 2 and safe motion solution PMCprotego DS for a safe drive solution

Technical details on SafetyNET p module from page 92:

Webcode: web150393

Online information at [www.pilz.com](http://www.pilz.com)

## ► Monitoring analog input signals safely

The analog input module PNOZ m EF 4AI provides four independent safe analog current inputs. The inputs are suitable for connecting transducers or encoders with standardized current signals. Any measured variables such as pressure, temperature, fill level, distance etc. can be safely recorded. Elements/blocks are available in the software tool PNOZmulti Configurator with which you can parameterize limit values and range monitoring with a few clicks of the mouse. In addition, you can already scale the analog measurement values in numerical quantities with any unit during the configuration. Arithmetic functions such as averaging, differential pressure calculation and similar facilitate its use for special applications. In combination with the visualization software PASvisu, analog values can be displayed and evaluated. The analog input module is suitable for many varied possible applications, in particular for the industries of process engineering and cable car and chair lift design.

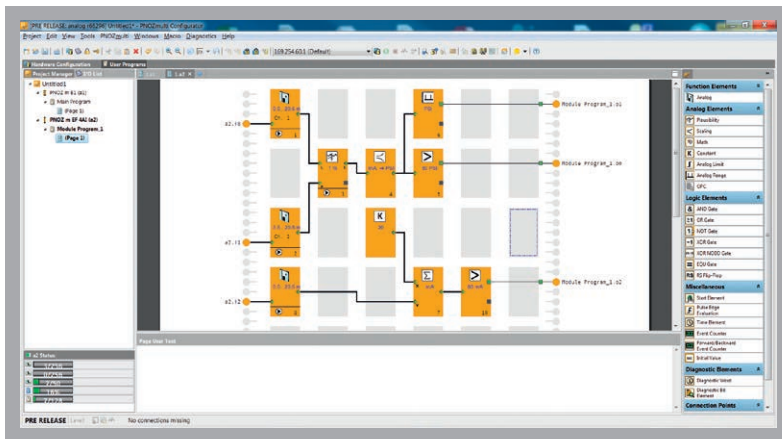

Configurable safe small controllers PNOZmulti 2: simple configuration of analog functions in the software tool PNOZmulti Configurator in a separate module program. Benefit: fast project planning thanks to new software blocks for input, feasibility, scaling and arithmetic functions with fine adjustment of the values. Quick and easy commissioning is possible thanks to the dynamic program display.

### Your benefits at a glance

- Safe and precise monitoring of process values: up to PL e, SIL CL 3
- Fast, simple project planning: new software blocks for input, feasibility, scaling and arithmetic functions
- Limit value and range monitoring can be parameterized
- Fast reaction times: module program technology mIQ with decentralized processing in the module
- User-friendly diagnostics: up to 6 analog values can be transferred to the fieldbus for each module
- Play it safe and use PNOZmulti 2 – the worldwide safety standard for all machine types

Keep up-to-date on configurable safe small controllers PNOZmulti 2:

 Webcode: web150500

Technical details from page 88. You can find a video tutorial on the configuration on our YouTube channel.

 Webcode: web150385

Online information at [www.pilz.com](http://www.pilz.com)

mIQ

FS-AI



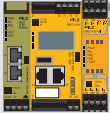

PNOZ m ES Profinet +  
PNOZ m B1 +  
PNOZ m EF 4AI

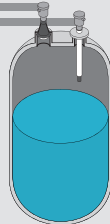

### Fill level measurement application

This example application shows the safe sensing of the fill level using a chemical tank as an example. Monitoring is performed with PNOZmulti 2 base unit PNOZ m B1 and analog module PNOZ m EF 4AI. Two non-safety-related sensors are connected to the analog module. The limit value and hysteresis are monitored. The two sensors are compared.

## ► For safe monitoring of your drives

### Safe motion monitoring modules

The safe motion monitoring modules PNOZ m EF 1MM/2MM for the configurable safe small controllers PNOZmulti 2 ensure safe monitoring of your drives. Together with a base unit PNOZ m B0 or PNOZ m B1 the expansion modules monitor one or two axes. You can easily configure the safe motion monitoring modules for PNOZmulti 2 using the software tool PNOZmulti Configurator. In the tool you can then also configure a separate module program (mlQ), which is then run directly on the motion monitoring module. This brings significant benefits to you as the user: it's possible to have fine granular configuration of several monitoring areas, such as velocity or rotational speed, which are then executed locally on the expansion module. That means greater flexibility for you as the user. User-friendly diagnostic options and a wide range of fieldbus and communications options are also available to you.

### Flexible and robust

All common incremental encoders can be connected using drive-specific connection cables via the **industry-compatible Mini I/O interface**, characterized by particularly high durability.

### Safe motion functions in accordance with EN/IEC 61800-5-2 and safe monitoring functions

EN/IEC 61800-5-2 describes so-called "safe motion functions" that are intended to reduce risks during ongoing operation. A safe monitoring function can be considered a supplementary safety function: the monitoring function is based on the normative motion function. Exceeding of parameterized limit values is signalled and PNOZmulti 2 triggers a safe reaction in the event of a fault and if detection zones/protected areas are violated.

More information on EN/IEC 61800-5-2:

Webcode:  
web200448

Online information at [www.pilz.com](http://www.pilz.com)

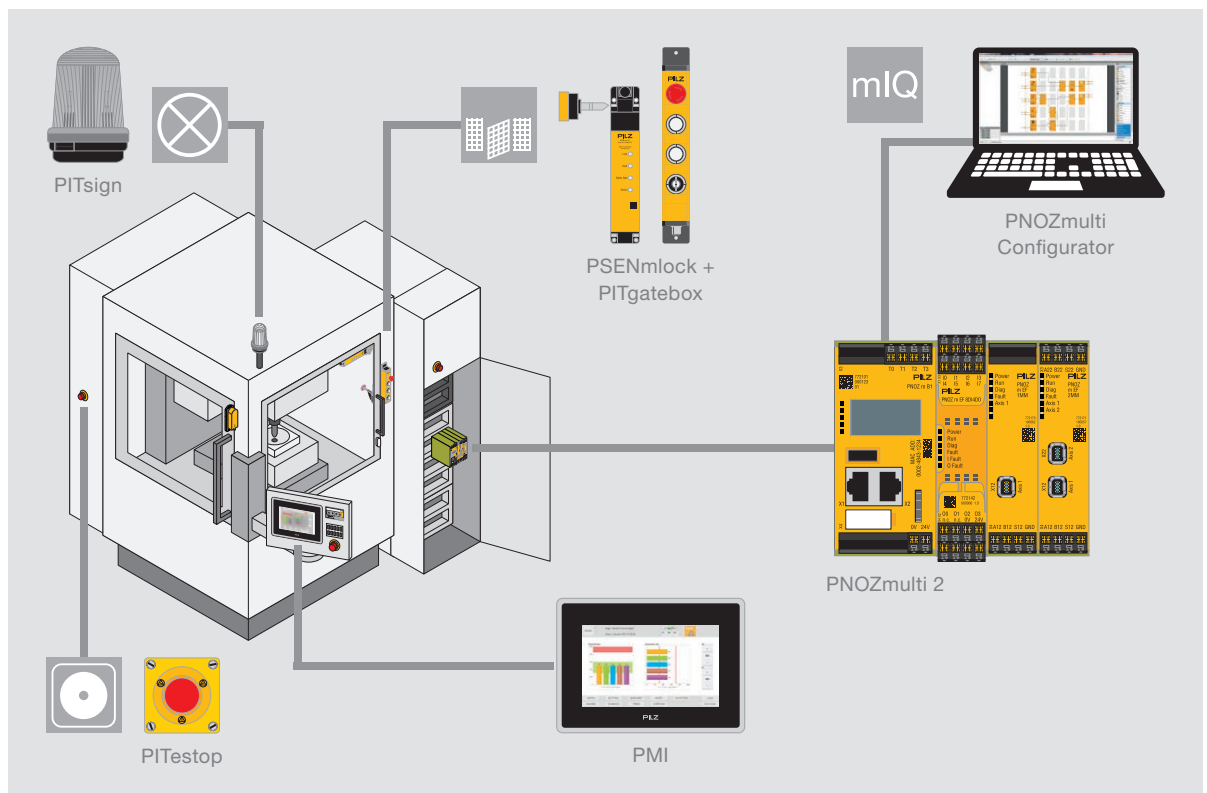

Accessories:

Webcode:  
web87010

Online information at [www.pilz.com](http://www.pilz.com)

Safe small controllers PNOZmulti 2 with module program (mlQ) for configuration of several monitoring areas, such as velocity or rotational speed, which are then executed locally on the expansion module.

**Available monitoring functions on the small controllers PNOZmulti 2**

- ▶ Safe stop 1: SS1
- ▶ Safe stop 2: SS2
- ▶ Safe speed monitor: SSM
- ▶ Safe speed range: SSR-M
- ▶ Safe direction: SDI-M
- ▶ Safe operating stop: SOS-M
- ▶ Safely limited acceleration: SLA-M
- ▶ Safe acceleration range: SAR-M
- ▶ Analog voltage (track S)

**Rotary encoder PSEnenco for safe motion monitoring!**

The safe incremental encoders PSEnenco send position changes of a machine or machine parts, e.g. in machine tools or presses, to the evaluation device such as the small controller PNOZmulti 2. You can output and evaluate HTL or SIN/COS signals to optimize the design of your application. The high resolution enables fast reaction times and precise measurements. Together with PNOZ m EF 1MM/2MM, PSEnenco offers safety functions for speed, direction, acceleration and standstill with different safety levels in the respective function. The quick and easy wiring is supported by M23 cables from Pilz.

**Your benefits at a glance**

- ▶ Maximum flexibility due to the new module program technology (mIQ): can be configured with the usual simplicity in the PNOZmulti Configurator
- ▶ Fast reaction times: lightens the load on the base unit
- ▶ Simple configuration of the motion monitoring safety functions via software blocks in the PNOZmulti Configurator
- ▶ Productive plant and machinery: with PNOZmulti 2 you have reduced costs with maximum safety
- ▶ Connection to all common incremental encoders via industry-compatible interface Mini I/O

**Your benefits at a glance**

- ▶ Enables speed and position-based safety functions
- ▶ High flexibility through scalable evaluation system
- ▶ High resolution enables fast reaction times and precise measurements
- ▶ Holistic safety solution for motion and position monitoring from a single source
- ▶ Simple, fast implementation



SS1



SS2



SSM



SSR-M



SDI-M



SOS-M



SLA-M



SAR-M

Configurable safe small controllers

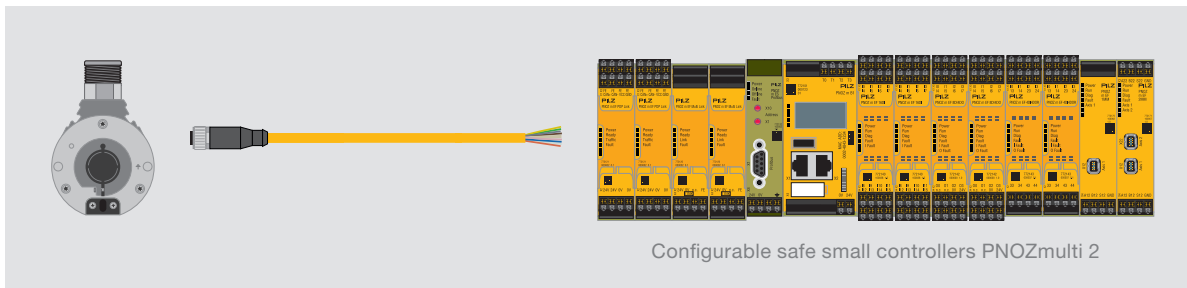

Configurable safe small controllers PNOZmulti 2

Technical details on the motion monitoring modules from page 90:

Webcode: web150385

Online information at [www.pilz.com](http://www.pilz.com)

Together with PNOZ m EF 1MM/2MM, PSEnenco offers safety functions for speed, direction, acceleration and standstill with different safety levels in the respective function.

## ► For safe press applications



### Dual-pole semiconductor output module PNOZ m EF 8DI2DOT

The dual-pole semiconductor output module PNOZ m EF 8DI2DOT is available to you for the safe monitoring of mechanical presses. Two safety outputs are used to control the press safety valves or other actuators that require dual-pole switching. You can configure the eight inputs with an individual filter time to enable correct operation with a variety of input signals. Press blocks in the software tool PNOZmulti Configurator, e.g. for operating modes or monitoring functions, make it easy and economical to use. A special advantage is the option of configuring a separate module program (mIQ), which is then run locally on the module with very short cycle times of approx. 3 ms. Output control is also extremely fast, so you benefit from very short reaction times of < 8 ms.

### Press elements/blocks in the software tool PNOZmulti Configurator:

- ▶ Operating modes such as setup, single-stroke, automatic
- ▶ Monitoring a mechanical rotary cam arrangement
- ▶ Run monitoring to monitor the mechanical transmission for shear pin breakage
- ▶ Monitoring of electrosensitive protective equipment in detection and/or cycle mode
- ▶ Control and monitoring of the press safety valve
- ▶ Cycle initiation via a two-hand control device

### Your benefits at a glance

- ▶ Maximum safety: simple configuration of press functions using certified software blocks with module program technology (mIQ) for each module
- ▶ Rapid reaction times (< 8 ms) and short cycle times of approx. 3 ms: press application is processed directly in the module
- ▶ Fine module-specific adjustment
- ▶ Particularly well suited for retrofit thanks to narrow width
- ▶ Depending on the application up to PL e, SIL CL 3
- ▶ Play it safe and use PNOZmulti 2 – the worldwide safety standard for all machine types

Technical details from page 90:

Webcode:  
web150500

Online information at [www.pilz.com](http://www.pilz.com)

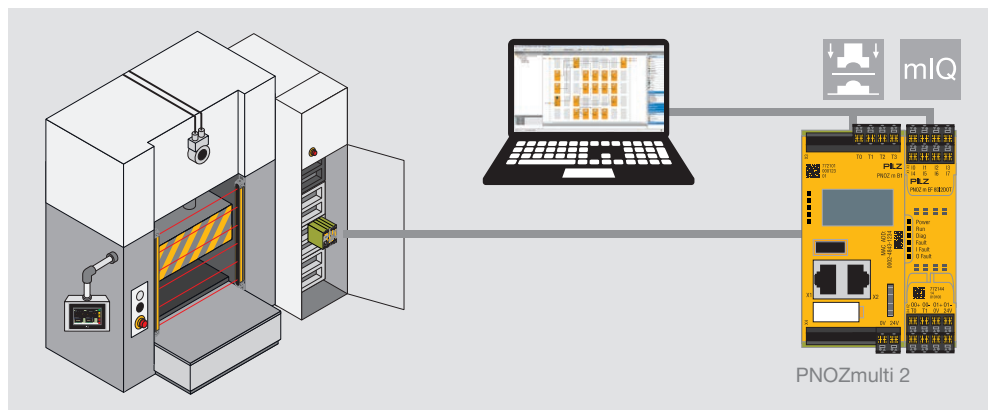

Configurable safe small controllers PNOZmulti 2: Base unit PNOZ m B1 with the dual-pole semiconductor output module PNOZ m EF 8DI2DOT for configuring safe press functions. The module program technology mIQ enables particularly fast reaction times (< 8 ms) and short cycle times of approx. 3 ms.

## ► For applications in industrial burner management

### Base unit PNOZ m B1 Burner in combination with software element “burner”

As a manufacturer of burner and heat-related plant and machinery, you must observe a number of legal and normative requirements. The safety requirements in particular are extremely stringent.

New to the range of safe small controllers PNOZmulti 2 is a base unit for the safe control and monitoring of furnaces. The base unit is configured in the software tool PNOZmulti Configurator with the burner element (function block) that reproduces the expanded functionality of a flexibly configurable electronic automatic burner control. You can thus easily configure a number of burner applications. These include various burner types, such as master burners or slave burners, direct or indirect ignition, low or high-temperature operation and much more.

### Tested and certified

Our solution has been tested and certified according to the corresponding standards, including EN 298, EN 50156 and NFPA 85/86. Testing according to international standards is in preparation.

### Your benefits at a glance

- Flexible and safe design of your furnace
- Saves lots of time during design and engineering as you can easily and quickly implement even complex safety applications with just one small controller
- Connection options with numerous automation environments and communication systems
- Maximum safety thanks to tested and certified hardware and software elements
- Tested and certified in accordance with EN 298, EN 50156, NFPA 85/86

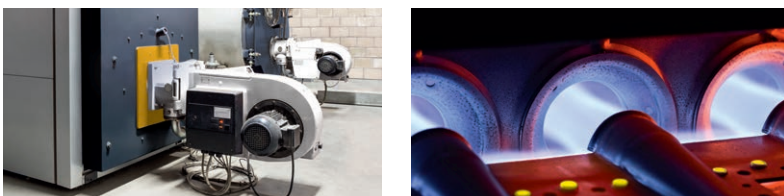

Webcode:  
web150382

Online information  
at [www.pilz.com](http://www.pilz.com)

Configurable safe small controllers PNOZmulti 2 for monitoring and controlling your furnace. All plant-dependent safety functions such as emergency stop, limit value monitoring and many others can also be monitored and controlled.

## ▶ Access permission and operating mode selection



### Access permissions with PITreader

The software tool PNOZmulti Configurator offers you an input element with which you can easily configure access permissions for plant and machinery. In combination with the base unit PNOZ m B1 and up to four reading units PITreader with RFID technology, you can implement authentications and authorizations for plant and machinery. Users can authenticate themselves on the PNOZmulti by inserting a transponder key into the read area of the PITreader; they will then be authorized to carry out certain operations. The permission on the transponder key must meet the condition for the required permission as configured. The options range from a simple enable and authentication of specific machine component functions to a complex hierarchical permission matrix. PITreader can be used flexibly as a stand-alone device or in conjunction with a controller from Pilz, in particular the base unit PNOZ m B1. PITreader and PNOZmulti 2 thus combine safety and security functions.

### Your benefits at a glance

- ▶ PITreader: Control of access permissions with excellent manipulation protection
- ▶ Every user is given the machine enables that match their abilities
- ▶ Functionally safe operating mode selection up to PL d/ SIL CL 2, using the operating mode selection and access permission system PITmode in combination with PITreader





# - made easy!

## Functionally safe operating mode selection PNOZmulti 2 and PITreader

In addition to the access permissions, you can configure the functionally safe operating mode selection on plant and machinery with new operating mode selector elements (function blocks) in the software tool PNOZmulti Configurator. In combination with the operating mode selection and access permission system PITmode, especially the PITreader, you have two convenient solutions for the operating mode selection. The permission for selection is configured in combination with PITreader and the corresponding RFID keys. In PNOZmulti 2 the selected operating mode can be read out.



PITreader



PIT oe4S



PMI v704e

Configurable safe small controllers

### PITreader with Pilz FS controller and LED pushbutton (PITmode flex)



#### Operating mode selection via button:

On the one hand, the operating mode can be selected via the Pilz PIT oe4S or also via conventional buttons.

### PITreader with Pilz FS controller and Pilz HMI (PITmode flex visu)



#### Operating mode selection via touch panel:

As an alternative, safe selection of the operating mode is possible via a key field on an HMI. The operator and visualization terminal PMIvisu thus enables safe selection of the operating mode.

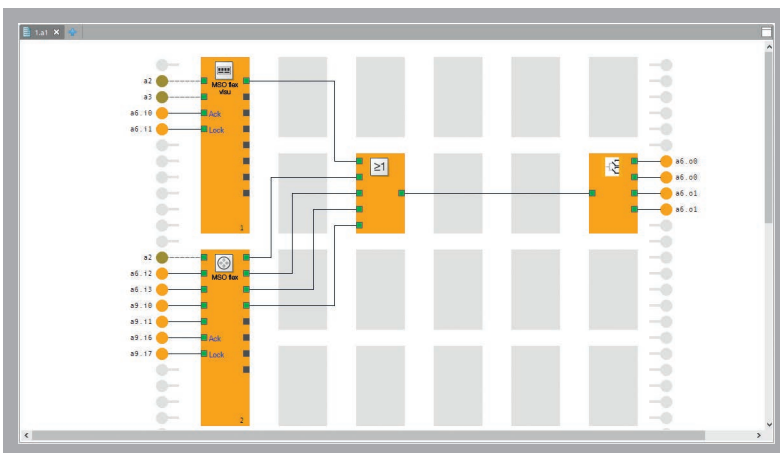

Monitor functionally safe operating mode selection in conjunction with small controllers PNOZmulti 2 and PITreader from the operating mode selection and access permission system PITmode! Two elements/function blocks are available in the PNOZmulti Configurator!

## ► The perfect combination – automation solutions

Safe sensors, operator and monitoring devices from Pilz guarantee the efficient, compliant use of plant and machinery in combination with the small controllers PNOZmulti 2. Our turnkey systems and universally compatible solutions offer a high savings potential. Our solutions can be used in almost all industries and applications.

### Safe protection zone monitoring with radar technology

The world's first complete solution for protection zone monitoring based on radar technology consists of the safe LBK System radar system from Inxpect S.p.A. and the configurable safe small controller PNOZmulti 2. This complete solution enables complex applications and rugged environments to be monitored safely, even outdoors. The robust radar technology ensures high availability even where there are external influences such as dust, dirt, rain, light, sparks or steam.

### Your benefits at a glance

- Series connection of up to 6 sensors
- Two protection zone configurations (narrow and wide) – depending on the size of the area to be monitored
- A Configurator is used to select the sensors and set up the protection zone
- Warning zone to signalize approaching objects
- Integral muting for the whole system or for individual sensors
- Restart interlock to prevent the machine restarting when there are people in the danger zone

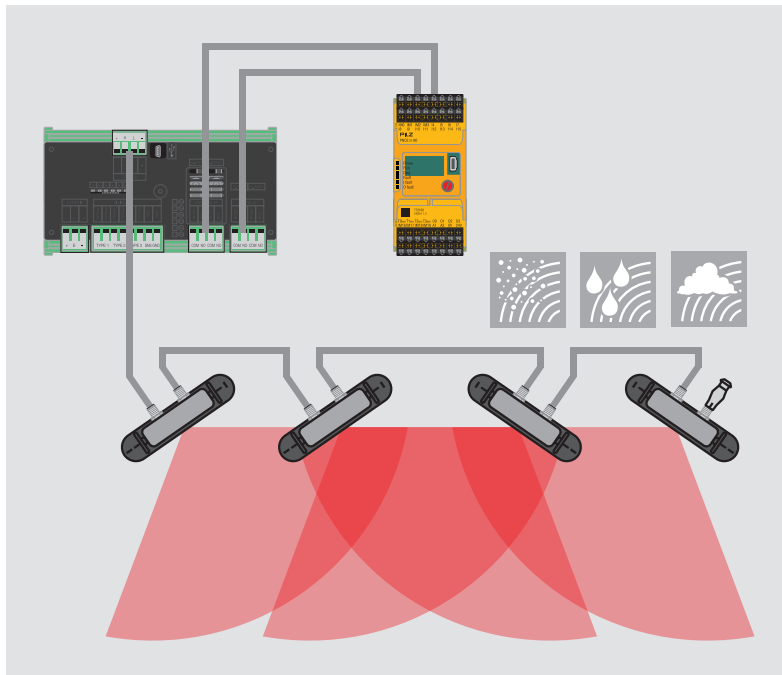

Monitoring of danger zones with the LBK System from Inxpect and the configurable safe small controller PNOZmulti 2.

Additional information on the LBK System:

Webcode:  
web199925

Online information at [www.pilz.com](http://www.pilz.com)



# from Pilz

## Safe complete solution with safety light curtains PSENOpt II

The safety light curtains PSENOpt II are used for safe intervention in the production process and, depending on the requirement, provide finger, hand and body protection. The first type 3 safety light curtains are specifically designed for applications up to PL d of EN/IEC 61496-1. Type 4 light curtains are also available for applications up to PL e of EN/IEC 61496-1/-2. The safety light curtains are available in the lengths of 150 mm to 1 800 mm. Combining with configurable safe small controllers PNOZmulti 2 gives you a safe, complete, one-stop solution. The compatible accessories range from fitting aids to mirror columns.

### Your benefits at a glance

- ▶ Body protection versions for applications up to PL e
- ▶ Highly robust for protection against shock, collision and vibration
- ▶ User-friendly diagnostics via LEDs to reduce downtimes
- ▶ Flexible use with enhanced safety – thanks to freedom from dead zones
- ▶ Coding for greater flexibility when installing the light curtains
- ▶ Economical, complete, one-stop solution with control technology from Pilz

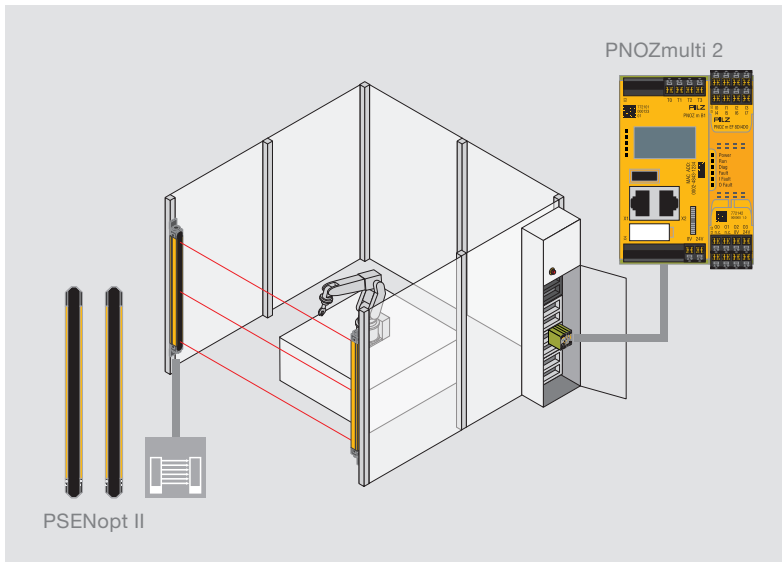

The perfect team: light curtain PSENOpt II and configurable safe small controller PNOZmulti 2.

Configurable safe small controllers



Additional information on the safety light curtains PSENOpt II:

Webcode:  
web150418

Online information at [www.pilz.com](http://www.pilz.com)

## ► The perfect combination – automation solutions

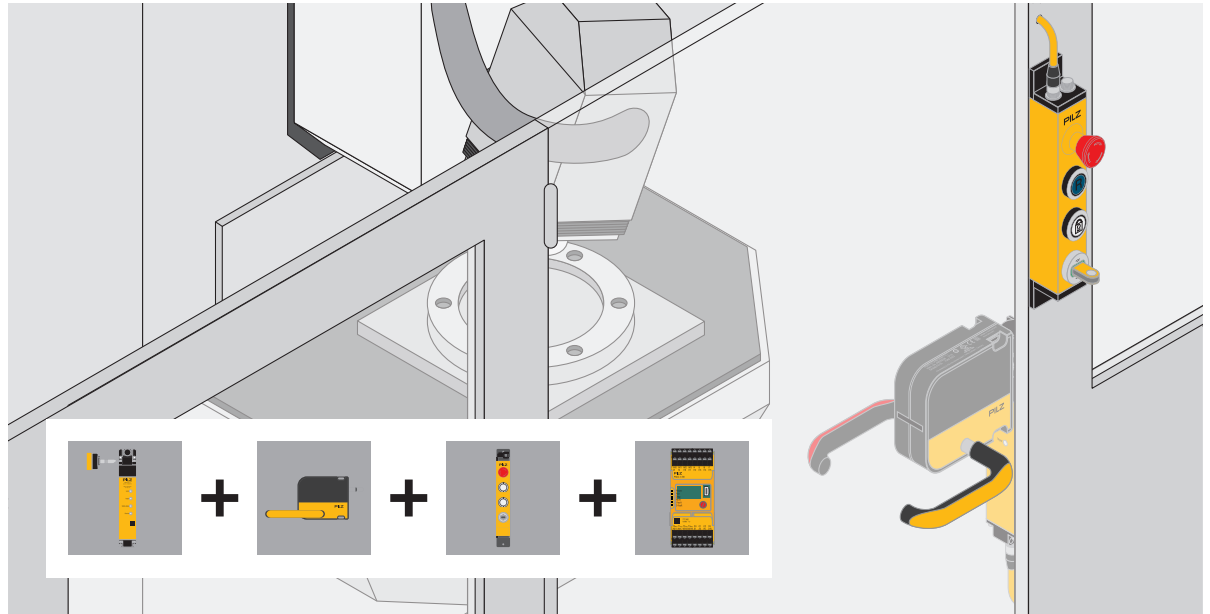

### Modular safety gate system

The modular safety gate system offers you an individual safety gate solution that is ideally tailored to your application. That means you can combine individual components flexibly to suit your own particular requirements.

Put together your system for safety gate monitoring – optionally with access permission management.

The following components are available for selection:

- ▶ Safety gate sensor PSEnmlock for safe interlocking and safe guard locking up to PL e. Different versions are available as a base unit, for series connection and with and without power reset
- ▶ PSEnmlock handle module for accessible safety gates with integrated escape release and simple, flexible installation inside and outside of the danger zone
- ▶ Escape releases and suitable handles for the safety gate system PSEnmlock
- ▶ Pushbutton unit PITgatebox for simple operation of the safety gate system, optionally with integrated access permission system PITreader
- ▶ Safety Device Diagnostics (SDD) for comprehensive diagnostic and status information as well as for the safe series connection of safety sensors and targeted individual control of the guard locking of individual switches in the series

Combining with the configurable safe small controller PNOZmulti 2 gives you a cost-effective, complete, one-stop solution.



from Pilz

Modular safety gate system – components			
<b>Sensor</b>	<b>PSEnmlock (safety guard locking device)</b> ▶ PSEnmlock base version (with/without auto. reset) ▶ PSEnmlock series connection (with/without auto. reset)		
<b>Handle</b>	<b>Handle module</b> Integrated escape release, for swing/sliding gates	<b>Handles</b> For swing gates	For sliding gates
		<b>Escape release</b> Classic escape release	Remote escape release
<b>Pushbutton unit</b>	<b>PITgatebox<sup>1)</sup></b>		
<b>Pushbutton unit with access permission system</b>	<b>PITgatebox with PITreader</b>		
<b>Evaluation device</b>	<b>Configurable safe small controllers PNOZmulti 2</b>		
<b>Diagnostics and targeted control</b>	<b>Safety Device Diagnostics</b>		

Additional information on the modular safety gate system:

Webcode: web194460

Online information at [www.pilz.com](http://www.pilz.com)

Configurable safe small controllers

<sup>1)</sup> Figure shows only one selection. Additional versions are available

### Firewall SecurityBridge – protect your controller

With the firewall SecurityBridge you protect the configurable safe small controllers PNOZmulti 2 against manipulation through unauthorized access. It is connected upstream of the base unit and functions as a VPN server. This banishes the spectre of espionage and manipulation, and guarantees the safety of your employees and the availability of your machinery! Further information from page 112.



Webcode: web188268

Online information at [www.pilz.com](http://www.pilz.com)

# ► Configurable safe small controllers PNOZmulti 2

## Configurable safe small controllers PNOZmulti 2 – base units

### Common features

- ▶ Modular and expandable
- ▶ Application range: for monitoring E-STOP buttons, two-hand buttons, safety gate limit switches, light beam devices, scanners, enable switches, safety gate switches PSEN, operating mode selector switches, pressure-sensitive mats, safe motion monitoring and many other applications
- ▶ Safety-related characteristic data: depending on the application, up to Performance Level PL e/Cat. 4 of EN ISO 13849-1 and Safety Integrity Level (SIL) CL 3 of EN/IEC 62061
- ▶ Can be configured using the software tool PNOZmulti Configurator
- ▶ Exchangeable program memory
- ▶ Illuminated display for status and device information
- ▶ If the diagnostic solution PVIS is activated, it is possible to display customized texts
- ▶ Visualization software PASvisu, with direct connection to PNOZmulti
- ▶ Supply voltage: 24 VDC
- ▶ LED status indicators
- ▶ Plug-in connection terminals: either spring-loaded terminals or screw terminals available as obligatory accessories



PNOZ m B1



PNOZ m B1 Burner



PNOZ m B0

Type	Features
<b>PNOZ m B1</b>	<ul style="list-style-type: none"> <li>▶ Automation project is transferred to the base unit using a USB stick (512 MB, included) or via the integrated ETH interface:                             <ul style="list-style-type: none"> <li>- multiple projects can be stored</li> <li>- only one can be executed</li> <li>- managed via the project manager</li> </ul> </li> <li>▶ Larger programs in the PNOZmulti Configurator only with PNOZ m B1:                             <ul style="list-style-type: none"> <li>- up to 1 024 connection lines possible</li> <li>- macro programming not yet available</li> <li>- module programs (mIQ) supported</li> </ul> </li> <li>▶ Date and time for PNOZ m B1 can be set in the PNOZmulti Configurator</li> <li>▶ USB stick as storage medium</li> </ul>
<b>PNOZ m B1 Burner</b>	<p>Base unit – specifically for burner management:</p> <ul style="list-style-type: none"> <li>▶ Control and monitoring of furnaces, e.g. monitoring of safety sequences, combustion air pressure, ignition, flame, external compound controller and leak-tightness control</li> <li>▶ Control of safety valves, ignition valves, exhaust valves, ignition, external compound controller and combustion air blowers</li> </ul>
<b>PNOZ m B0</b>	<ul style="list-style-type: none"> <li>▶ Automation project is transferred to the base unit using a chip card (not included, available as an accessory) or via the integrated USB interface</li> <li>▶ 20 safe inputs, up to 8 of which can be configured as auxiliary outputs</li> <li>▶ 4 safe semiconductor outputs, depending on the application up to PL e, SIL CL 3</li> <li>▶ Chip card as storage medium</li> </ul>

# technical details

	Certification	Order number		
		Without terminals	Plug-in spring-loaded terminals	Plug-in screw terminals
<ul style="list-style-type: none"> <li>▶ 4 test pulse outputs for detecting shorts across contacts between the inputs, otherwise no inputs and outputs on the base unit</li> <li>▶ Right side: max. 12 safe expansion modules, 1 output module for standard applications</li> <li>▶ Left side: up to 4 safe link modules, max. 1 fieldbus module</li> <li>▶ Modbus TCP on board</li> <li>▶ Display with backlighting for diagnostics, for activating the project, Ethernet settings, for setting the date and time of the system, for stopping and starting the device</li> <li>▶ Multifunction switch for menu control</li> <li>▶ 2 Ethernet interfaces with switch: transmission rate 10 MBit/s, 100 MBit/s; connector type RJ45</li> <li>▶ Dimensions (H x W x D) in mm: 100 x 45 x 120.2</li> </ul>	CE, cULus Listed, EAC (Eurasian), TÜV, KOSHA	772101  RJ45 cable ▶ 1.5 m _____ 314094	751016	750016
<ul style="list-style-type: none"> <li>▶ Monitoring of the following oil and gas burner types: Master burner with direct ignition, master burner with indirect ignition and joint flame monitoring</li> <li>▶ Up to 12 burner function blocks can be configured per base unit</li> <li>▶ Safety-related characteristic data: depending on the application, up to Performance Level PL e/ Cat. 4 of EN ISO 13849-1 and Safety Integrity Level (SIL) CL 3 of IEC 61508</li> <li>▶ Other features: as for PNOZ m B1</li> </ul>	CE, cULus Listed, EAC (Eurasian), TÜV, KOSHA	772102	751016	750016
<ul style="list-style-type: none"> <li>▶ 4 test pulse outputs, up to 4 of which can be configured as standard outputs</li> <li>▶ Right side: max. 6 safe expansion modules</li> <li>▶ Left side: max. 4 safe link modules, max. 1 fieldbus module and max. 1 communication module</li> <li>▶ Display with backlighting to indicate the status of the supply voltage and the inputs and outputs</li> <li>▶ Rotary knob for menu control</li> <li>▶ Dimensions (H x W x D) in mm: 101.4/98<sup>1)</sup> x 45 x 120</li> </ul>	CE, cULus Listed, EAC (Eurasian), TÜV, KOSHA	772100  Mini USB cable ▶ 3 m _____ 312992 ▶ 5 m _____ 312993  ▶ Chip card 8 kByte 1 piece ____ 779201 ▶ Chip card 32 kByte 1 piece ____ 779211	751008 (1 set)	750008 (1 set)

<sup>1)</sup> Height incl. plug-in spring-loaded terminals/screw terminals

Keep up-to-date on PNOZmulti 2 base units:

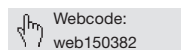

Online information at [www.pilz.com](http://www.pilz.com)

## ► Configurable safe small controllers PNOZmulti 2

### Configurable safe small controllers PNOZmulti 2 – expansion modules, connectible on the right



PNOZ m EF 16DI



PNOZ m EF 4AI



PNOZ m EF 8DI4DO



PNOZ m EF 4DI4DOR

Type	Application area
PNOZ m EF 16DI	Safe input module
PNOZ m EF 4AI	Safe analog input module
PNOZ m EF 8DI4DO	Safe input/semiconductor output module
PNOZ m EF 4DI4DOR	Safe input/relay output module

#### Common features

- For each expansion module PNOZ m EF 4AI, PNOZ m EF 8DI2DOT, PNOZ m EF 1MM/2MM a separate module program (mIQ) with 256 connection lines can be configured. The user program consists of a main program and one or more module programs. The module program is set up like the main program. Configuration is performed directly in the module program. Processing is decentralized and occurs in the module.



# technical details

Features	Certification	Order number		
		Without terminals	Plug-in spring-loaded terminals	Plug-in screw terminals
<ul style="list-style-type: none"> <li>▶ 16 safe inputs</li> <li>▶ Monitoring of shorts across contacts by means of test pulse outputs at the inputs</li> <li>▶ Dimensions (H x W x D) in mm: 101.4 x 22.5 x 120</li> </ul>	CE, cULus Listed, EAC (Eurasian), TÜV, KOSHA	772 140	751 004 (1 set)	750 004 (1 set)
<ul style="list-style-type: none"> <li>▶ 4 independent safe analog current inputs, each input can be configured separately</li> <li>▶ Current range: 4 ... 20 mA, measuring range: 0 ... 25 mA</li> <li>▶ Resolution: 15 bit + sign bit; sampling rate: 10 kHz</li> <li>▶ Workspace monitoring in accordance with Namur NE 43 (range limits are freely configurable)</li> <li>▶ Limit value/range monitoring (limit values freely configurable)</li> <li>▶ Safety-related characteristic data: depending on the application, up to PL e in accordance with EN ISO 13849-1 and up to SIL CL 3 in accordance with EN/IEC 62061</li> <li>▶ Exact analog values can be passed on via fieldbus to a higher level controller for diagnostic purposes. Visualization via the web-based software PASvisu.</li> <li>▶ Dimensions (H x W x D) in mm: 101.4 x 22.5 x 120</li> </ul>	CE, cULus Listed, EAC (Eurasian), TÜV, KOSHA	772 160	751 004 (1 set)	750 004 (1 set)
<ul style="list-style-type: none"> <li>▶ 8 safe inputs</li> <li>▶ 4 safe semiconductor outputs, depending on the application up to PL e, SIL CL 3</li> <li>▶ Dimensions (H x W x D) in mm: 101.4 x 22.5 x 120</li> </ul>	CE, cULus Listed, EAC (Eurasian), TÜV, KOSHA	772 142	751 004 (1 set)	750 004 (1 set)
<ul style="list-style-type: none"> <li>▶ 4 safe inputs</li> <li>▶ 4 safe relay outputs, depending on the application up to PL e and SIL CL 3</li> <li>▶ Dimensions (H x W x D) in mm: 101.4 x 22.5 x 120</li> </ul>	CE, cULus Listed, EAC (Eurasian), TÜV, KOSHA	772 143	751 004 (1 set)	750 004 (1 set)

In order to use the full scope of the PNOZmulti Configurator, you will need a valid license in addition to the software package. Purchasing a license converts the demo software with restricted functionality to a full version. Information on the available licenses can be found at [www.pilz.com](http://www.pilz.com), webcode: web151344

Demo software can be downloaded from the Internet (for registered users), information at [www.pilz.com/pnozmulti-tools](http://www.pilz.com/pnozmulti-tools), webcode: web150399

Keep up-to-date on PNOZmulti 2 I/O modules:

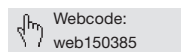

Online information at [www.pilz.com](http://www.pilz.com)

## ► Configurable safe small controllers PNOZmulti 2

### Configurable safe small controllers PNOZmulti 2 – expansion modules, connectible on the right



PNOZ m EF 8DI2DOT



PNOZ m EF 1MM



PNOZ m EF 2MM



PNOZ m ES 14DO

Type	Application area
PNOZ m EF 8DI2DOT	Dual-pole semiconductor output module
PNOZ m EF 1MM	Safe motion monitoring module for monitoring one axis
PNOZ m EF 2MM	Safe motion monitoring module for monitoring two axes
PNOZ m ES 14DO	Output module for standard applications

#### Common features

- For each expansion module PNOZ m EF 4AI, PNOZ m EF 8DI2DOT, PNOZ m EF 1MM/2MM a separate module program (mIQ) with 256 connection lines can be configured. The user program consists of a main program and one or more module programs. The module program is set up like the main program. Configuration is performed directly in the module program. Processing is decentralized and occurs in the module.

# technical details

Features	Certification	Order number		
		Without terminals	Plug-in spring-loaded terminals	Plug-in screw terminals
<ul style="list-style-type: none"> <li>▶ 2 dual-pole safety outputs using semiconductor technology: Depending on the application, up to PL e in accordance with EN ISO 13849-1 and up to SIL CL 3 in accordance with EN/IEC 62061. The outputs are suitable for controlling a press safety valve in accordance with EN ISO 16092-2. Open circuit detection can be configured</li> <li>▶ 8 digital inputs: the inputs can be used to evaluate a run monitor for press applications. Configurable pulse suppression at the inputs.</li> <li>▶ 2 test pulse outputs for detection of shorts across contacts</li> <li>▶ Press elements in the PNOZmulti Configurator: operating modes such as setup, single-stroke and automatic; monitoring a mechanical rotary cam arrangement; run monitoring to monitor the mechanical transmission for shear pin breakage; monitoring of electrosensitive protective equipment in detection and/or cycle mode; control and monitoring of the press safety valve plus cycle initiation via a two-hand control device</li> <li>▶ Dimensions (H x W x D) in mm: 101.4 x 22.5 x 120</li> </ul>	CE, cULus Listed, EAC (Eurasian), TÜV, KOSHA	772 144	751 004 (1 set)	750 004 (1 set)
<ul style="list-style-type: none"> <li>▶ Safe monitoring functions in accordance with EN 61800-5-2 (electrical power drive systems with adjustable speed)                             <ul style="list-style-type: none"> <li>- Stop 1 (SS1) and stop 2 (SS2)</li> <li>- Safe speed monitoring (SSM)</li> <li>- Safe speed range monitoring (SSR-M)</li> <li>- Safe direction monitoring (SDI-M)</li> <li>- Safe operating stop monitoring (SOS-M)</li> <li>- Safely limited acceleration (SLA-M)</li> <li>- Safe acceleration range (SAR-M)</li> <li>- Analog voltage (track S)</li> </ul> </li> <li>▶ Dimensions (H x W x D) in mm: 101.4 x 22.5 x 111</li> </ul>	CE, cULus Listed, EAC (Eurasian), TÜV, KOSHA	772 170	783 542 (1 set)	793 542 (1 set)
	CE, cULus Listed, EAC (Eurasian), TÜV, KOSHA	772 171	783 544 (1 set)	793 544 (1 set)
<ul style="list-style-type: none"> <li>▶ Expansion module with 14 semiconductor outputs for non-safety-related applications</li> <li>▶ Max. 1 output module can be connected on the right side of the base unit PNOZ m B1</li> <li>▶ Dimensions (H x W x D) in mm: 101.4 x 22.5 x 120</li> </ul>	CE	772 181	751 004 (1 set)	750 004 (1 set)

In order to use the full scope of the PNOZmulti Configurator, you will need a valid license in addition to the software package. Purchasing a license converts the demo software with restricted functionality to a full version. Information on the available licenses can be found at [www.pilz.com](http://www.pilz.com), webcode: web151344

Demo software can be downloaded from the Internet (for registered users), information at [www.pilz.com/pnozmulti-tools](http://www.pilz.com/pnozmulti-tools), webcode: web150399

Keep up-to-date on PNOZmulti 2 I/O modules:

 Webcode: web150385

Online information at [www.pilz.com](http://www.pilz.com)

## ► Configurable safe small controllers PNOZmulti 2

### Configurable safe small controllers PNOZmulti 2 – expansion modules, connectible on the left



PNOZ m EF PDP Link



PNOZ m EF Multi Link



PNOZ m EF SafetyNET

Type	Application area
PNOZ m EF PDP Link	Safe link module for connecting a base unit to up to 4 decentralized modules PDP67
PNOZ m EF Multi Link	Safe link module for connecting two base units. As many base units as needed can be connected via link modules
PNOZ m EF SafetyNET	Expansion module for safe data exchange between SafetyNET p subscribers via SafetyNET p RTFL
PDP67 F 8DI ION PDP67 F 8DI ION HP	Decentralized input modules

#### Common features

- Can be configured with the software tool PNOZmulti Configurator
- Status indicators via LEDs

# technical details

Features	Certification	Order number		
		Without terminals	Plug-in spring-loaded terminals	Plug-in screw terminals
<ul style="list-style-type: none"> <li>▶ Maximum number of devices which can be connected:                             <ul style="list-style-type: none"> <li>- 4 PDP link modules on the left side of the base unit</li> <li>- 4 decentralized modules PDP67 F 8DI ION (VA) or PDP67 F 8DI ION HP (VA) to 1 PDP link module (maximum configuration: 16 PDP67 modules)</li> <li>- 4 sensors to 1 decentralized PDP67 module (maximum configuration: 64 sensors)</li> </ul> </li> <li>▶ Dimensions (H x W x D) in mm: 101.4 x 22.5 x 120</li> </ul>	CE, cULus Listed, EAC (Eurasian), TÜV, KOSHA	772 121	783 540 (1 set)	793 540 (1 set)
<ul style="list-style-type: none"> <li>▶ On the left side, max. 4 multi-link modules can be connected to the base unit</li> <li>▶ Point-to-point connection via 4-core shielded, twisted-pair cable</li> <li>▶ Transfer of 32 bit input data and 32 bit output data (virtual I/Os)</li> <li>▶ Dimensions (H x W x D) in mm: 101.4 x 22.5 x 120</li> </ul>	CE, cULus Listed, EAC (Eurasian), TÜV, KOSHA	772 120	783 538 (1 set)	793 538 (1 set)
<ul style="list-style-type: none"> <li>▶ Safe communication via the real-time Ethernet SafetyNET p RTFL</li> <li>▶ In the PNOZmulti Configurator up to 128 virtual inputs and 32 virtual outputs can be defined for safe communication via SafetyNET p</li> <li>▶ Every PNOZmulti 2 SafetyNET p subscriber (base unit PNOZmulti 2) is assigned a module PNOZ m EF SafetyNET</li> <li>▶ Up to 16 SafetyNET p subscribers can be connected in a linear structure</li> <li>▶ Maximum of 1 fieldbus module can in addition be connected</li> <li>▶ Dimensions in mm (H x W x D): 96 x 45 x 110.7</li> </ul>	CE, cULus Listed, EAC (Eurasian), TÜV	772 122	751 017 (1 set)	750 017 (1 set)
For information please refer to pages 100–101	-	-	-	-

In order to use the full scope of the PNOZmulti Configurator, you will need a valid license in addition to the software package. Purchasing a license converts the demo software with restricted functionality to a full version. Information on the available licenses can be found at [www.pilz.com](http://www.pilz.com), webcode: web151344

Demo software can be downloaded from the Internet (for registered users), information at [www.pilz.com/pnozmulti-tools](http://www.pilz.com/pnozmulti-tools), webcode: web150399

Keep up-to-date on PNOZmulti 2 I/O modules:

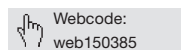

Online information at [www.pilz.com](http://www.pilz.com)

## ► Configurable safe small controllers PNOZmulti 2

**Configurable safe small controllers PNOZmulti 2 – communication/fieldbus modules, connectible on the left**



Type	Application area
PNOZ m ES PROFINET	Fieldbus module PROFINET (I/O device)
PNOZ m ES PROFIBUS	Fieldbus module PROFIBUS-DP (slave, DPV0)
PNOZ m ES EtherCAT	Fieldbus module EtherCAT (slave, CANopen over EtherCAT)
PNOZ m ES EtherNet/IP	Fieldbus module EtherNet/IP (adapter)
PNOZ m ES POWERLINK	Fieldbus module Ethernet POWERLINK V2 (slave)
PNOZ m ES CANopen	Fieldbus module CANopen (slave, CiA 301 V 4.2.0)
PNOZ m ES CC-Link	Fieldbus module CC-Link
PNOZ m ES ETH	Communication module with Ethernet/Modbus TCP interface
PNOZ m ES RS232	Communication module with serial interface

**Common features**

- Can be configured with the software tool PNOZmulti Configurator
- Status indicators via LEDs

# technical details

Features	Certification	Order number		
		Without terminals	Plug-in spring-loaded terminals	Plug-in screw terminals
<ul style="list-style-type: none"> <li>▶ Transmission rate 100 MBit/s (100BaseTX), full-duplex and half-duplex</li> <li>▶ Two RJ45 ports</li> <li>▶ PROFINET I/O Device (V2.2) functions in accordance with conformance class C</li> <li>▶ Supported functions: RT, IRT, MRP, LLDP</li> <li>▶ Dimensions (H x W x D) in mm: 101.4 x 22.5 x 110.4</li> </ul>	CE, cULus Listed, EAC (Eurasian)	772 138	783 542 (1 set)	793 542 (1 set)
<ul style="list-style-type: none"> <li>▶ Station addresses from 0 ... 99, selected via rotary switch</li> <li>▶ Transmission rate: max. 12 MBit/s</li> <li>▶ Connection to fieldbus via female 9-pin D-Sub connector</li> <li>▶ Dimensions (H x W x D) in mm: 101.4 x 22.5 x 115</li> </ul>	CE, cULus Listed, EAC (Eurasian)	772 132	783 542 (1 set)	793 542 (1 set)
<ul style="list-style-type: none"> <li>▶ Transmission rate: 100 MBit/s</li> <li>▶ Max. 148 bytes TxPDO and 20 bytes RxPDO</li> <li>▶ Connection to fieldbus via RJ45 connector</li> <li>▶ Dimensions (H x W x D) in mm: 101.4 x 22.5 x 115</li> </ul>	CE, cULus Listed, EAC (Eurasian)	772 136	783 542 (1 set)	793 542 (1 set)
<ul style="list-style-type: none"> <li>▶ Transmission rate: 10 MBit/s, 100 MBit/s</li> <li>▶ IP address is set at DIP switch on the front of the unit</li> <li>▶ 2-port switch</li> <li>▶ Connection to fieldbus via RJ45 connector</li> <li>▶ Integrated web server</li> <li>▶ Dimensions (H x W x D) in mm: 101.4 x 22.5 x 110.4</li> </ul>	CE, cULus Listed, EAC (Eurasian)	772 137	783 542 (1 set)	793 542 (1 set)
<ul style="list-style-type: none"> <li>▶ Station addresses from 1 ... 239, selected via rotary switch</li> <li>▶ Transmission rate: 100 MBit/s</li> <li>▶ Connection to fieldbus via RJ45 connector</li> <li>▶ Dimensions (H x W x D) in mm: 101.4 x 22.5 x 110.4</li> </ul>	CE, cULus Listed, EAC (Eurasian)	772 119	783 542 (1 set)	793 542 (1 set)
<ul style="list-style-type: none"> <li>▶ Station addresses from 0 ... 99, selected via rotary switch</li> <li>▶ Transmission rate: max. 1 MBit/s</li> <li>▶ Transmission rate selected via rotary switch</li> <li>▶ Connection to fieldbus via male 9-pin D-Sub connector</li> <li>▶ Dimensions (H x W x D) in mm: 101.4 x 22.5 x 115</li> </ul>	CE, cULus Listed, EAC (Eurasian)	772 134	783 542 (1 set)	793 542 (1 set)
<ul style="list-style-type: none"> <li>▶ Station addresses from 1 ... 63, selected via rotary switch</li> <li>▶ Station type: remote device</li> <li>▶ Occupied stations: 3</li> <li>▶ Transmission rate: max. 10 MBit/s</li> <li>▶ Connection to fieldbus: via 5-pin Combicon plug-in connector</li> <li>▶ Dimensions (H x W x D) in mm: 101.4 x 22.5 x 110.4</li> </ul>	CE, EAC (Eurasian)	772 135	783 542 (1 set)	793 542 (1 set)
<ul style="list-style-type: none"> <li>▶ With 2 Ethernet interfaces</li> <li>▶ Transmission rate 10 MBit/s or 100 MBit/s</li> <li>▶ Connection to fieldbus via RJ45 connector</li> <li>▶ Can only be used with base unit PNOZ m B0</li> <li>▶ Dimensions (H x W x D) in mm: 101.4 x 22.5 x 111</li> </ul>	CE, cULus Listed, EAC (Eurasian)	772 130	-	-
<ul style="list-style-type: none"> <li>▶ 1 serial interface RS232</li> <li>▶ Can only be used with base unit PNOZ m B0</li> <li>▶ Dimensions (H x W x D) in mm: 101.4 x 22.5 x 120</li> </ul>	CE, cULus Listed, EAC (Eurasian)	772 131	783 538 (1 set)	793 538 (1 set)

Keep up-to-date on PNOZmulti 2 communication modules:

 Webcode: web150393

Online information at [www.pilz.com](http://www.pilz.com)

In order to use the full scope of the PNOZmulti Configurator, you will need a valid license in addition to the software package. Purchasing a license converts the demo software with restricted functionality to a full version. Information on the available licenses can be found at [www.pilz.com](http://www.pilz.com), webcode: web151344

Demo software can be downloaded from the Internet (for registered users), information at [www.pilz.com/pnozmulti-tools](http://www.pilz.com/pnozmulti-tools), webcode: web150399

## ► Software tools for small controllers

### Software tool – PNOZmulti Configurator



Type	Features
PNOZmulti Configurator	<ul style="list-style-type: none"> <li>▶ Graphical tool for configuring and programming the configurable small controllers PNOZmulti</li> <li>▶ Project development, configuration generation, documentation and commissioning</li> <li>▶ Data transmission varies depending on the used base unit: via USB interface, ETH interface, chip card or USB stick</li> <li>▶ User interface in German, English, French, Italian, Spanish, Japanese and Chinese (selectable)</li> <li>▶ System requirements (version 10.0.0 or higher):                         <ul style="list-style-type: none"> <li>- Operating system: Windows 7; 8; 8.1; 10 ... (32 Bit, 64 Bit)</li> <li>- Standard PC with min. 1 GHz processor</li> <li>- RAM: min. 1 024 MB</li> <li>- Hard drive: 20 GB; min. 15 GB free memory space</li> <li>- Graphics card: Supports Super VGA graphics</li> <li>- Browser: Internet Explorer version 9 or higher</li> </ul> </li> <li>▶ To be able to fully utilize the PNOZmulti Configurator, you will need a valid license in addition to the software package because without a license the PNOZmulti Configurator will only run in the demo version; various licenses are available</li> <li>▶ Each license type is available as a full version or service version                         <ul style="list-style-type: none"> <li>- Full version: the full version provides the whole functional range of a license</li> <li>- Service version: the service version of a license is intended for service and maintenance; it provides only limited editing options</li> </ul> </li> </ul>

### Software tool – Diagnostic solution PVIS



Type	Features
PVIS	Diagnostic configurations can be created for all PVIS-capable controllers. This is done using the respective system software of the controller, e.g. using the PNOZmulti Configurator. The diagnostic configuration contains event notifications which can be displayed e.g. if errors occur in or at the controller, if the operating status of the control system changes or in the case of defined conditions.
PVIS OPC Server UA/OPC Server	The OPC Server "PVIS OPC Server UA" from Pilz is used for displaying the event notifications in visualization software. The OPC Server is installed on a PC or a PMI operator terminal.
PVIS OPC Configurator	The PVIS OPC Configurator is used to create an OPC project which contains the diagnostic configurations and the OPC data for the individual controller. The OPC Server connects to the controllers, reads in the data and makes it available in the namespace. In the namespace, not only the event notifications can be viewed but also status information and the process data of the controllers.
ActiveX Control UA/ActiveX Control	In order to retrieve the event notifications of a controller from the OPC Server and to display them in visualization software, ActiveX control can use "PVIS ActiveX Control UA".



License type	Order number		
	Type	Full version	Service version
<ul style="list-style-type: none"> <li>▶ <b>Basic License:</b> Single user license, issued to one owner (company name and location/project must be stated)</li> <li>▶ <b>User License:</b> Discounted license for an additional workstation, issued to the owner of a basic license</li> <li>▶ <b>Multi User License:</b> Multi-user license, graduated according to the number of workstations (up to 25, 50, 100 and over 100)</li> <li>▶ <b>Project License:</b> License to use the software within a contractually limited framework</li> <li>▶ <b>Basic/User/Multi User/Project Upgrade License:</b> Discounted license to allow existing license owners to upgrade to a newer version of the software</li> <li>▶ <b>Time Limited License:</b> Basic license limited to 2, 3 or 4 months</li> </ul>	Software can be downloaded from the Internet		
	▶ Basic License	773 010B	773 011B
	▶ User License	773010K	773011K
	▶ Multi User License	773010M	773011M
	▶ Project License	773010G	773011G
	▶ Time Limited License, 2 months	773010S	-
	▶ Time Limited License, 3 months	773010R	-
	▶ Time Limited License, 4 months	773010Q	-
	<b>Upgrade</b>		
	▶ Basic Upgrade License	773010U	773011U
	▶ User Upgrade License	773010V	773011V
	▶ Multi User Upgrade License	773010N	773011N
	▶ Project Upgrade License	773010W	773011W

Keep up-to-date on the software tool PNOZmulti Configurator:

 Webcode: web150399

Licenses:

 Webcode: web151344

Online information at [www.pilz.com](http://www.pilz.com)

License type	Order number		
	Type	Runtime license	Project license
<ul style="list-style-type: none"> <li>▶ <b>Runtime license:</b> OPC/OPC UA server application which is licensed for a target computer and can be used without time restriction</li> <li>▶ <b>Project license:</b> License to use the software within a contractually limited framework</li> </ul>	PVIS OPC Server for PMI, point-to-point	261 905	261 905G
	PVIS OPC Server for PMI, 8 devices	261 906	261 906G
	PVIS OPC Server for PC, point-to-point	261 907	261 907G
	PVIS OPC Server for PC, unlimited	261 908	261 908G

Keep up-to-date on the software tool "Diagnostic solution PVIS":

 Webcode: web150398

Online information at [www.pilz.com](http://www.pilz.com)

## ▶ Accessories – configurable safe small controllers

### Accessories – configurable safe small controllers PNOZmulti 2



PNOZmulti Toolkit



Chipcard



SafetyNET p Cable



PSEN ma adapter

Type	Application range/features	Order number
<b>PNOZmulti Toolkit</b>	The tool kit includes: chip card with 32k and seal PNOZmulti m1p VP: 10 pcs., chip card reader PNOZmulti, programming cable PNOZmulti, system manual PNOZmulti	779000
<b>USB memory 512 MB</b>	For base unit PNOZ m B1, for follow-up orders only	779213
<b>Chipcard</b>	Chip card for the base units PNOZ m B0, PNOZmulti Mini, PNOZmulti (obligatory accessories)	<ul style="list-style-type: none"> <li>▶ 8 kByte, 1 pieces ____ 779201</li> <li>▶ 8 kByte, 10 pieces ____ 779200</li> <li>▶ 32 kByte, 1 pieces ____ 779211</li> <li>▶ 32 kByte, 10 pieces ____ 779212</li> </ul>
<b>Chipcard Holder</b>	Chip card holder	779240
<b>Chipcard Reader</b>	Chip card reader, PNOZmulti Configurator version 9.6.0 or higher	779230
<b>PNOZmulti Seal</b>	Adhesive label for chip card, 12 pieces	779250
<b>SafetyNET p Cable</b>	Connection cable for all link modules of the small controllers PNOZmulti, available by the meter 1 ... 500 m, signal yellow RAL1003, 4-core, without connector	380000
	Connector X1/X2-RJ45 male connector (straight)	<ul style="list-style-type: none"> <li>▶ 0.5 m _____ 380001</li> <li>▶ 1 m _____ 380003</li> <li>▶ 2 m _____ 380005</li> <li>▶ 5 m _____ 380007</li> <li>▶ 10 m _____ 380009</li> </ul>
<b>SafetyNET p Connector RJ45s</b>	Plug-in connector	380400
<b>RJ45 Connector</b>	Pin connector	380401
<b>PSSu A RJ45-CAB 1.5M</b>	Patch cable with RJ45 connector, light grey	▶ 1.5 m _____ 314094
<b>PSSu A USB-CAB03</b>	Mini USB cable for the base units PNOZ m B0 and PNOZmulti Mini	<ul style="list-style-type: none"> <li>▶ 3 m _____ 312992</li> <li>▶ 5 m _____ 312993</li> </ul>
<b>PSEN ma adapter</b>	Adapter for connection to PSENmag safety switches	380300
<b>PSEN cs adapter</b>	Adapter for connection to PSENcode safety switches	380301

# PNOZmulti 2

## Accessories – configurable safe small controllers PNOZmulti 2



PNOZ msi1Ap



MM A MINI-IO-CAB

Type	Application range/features	Order number
<b>PNOZ msi1Ap</b> Adapter Si/Ha 25/25	▶ Connection cable for the safe speed and standstill monitors PNOZ ms1p/PNOZ ms2p/PNOZ ms3p, used to connect incremental encoders	▶ 2.5 m _____ 773 840
<b>PNOZ msi1Bp</b> Adapter Si/Ha 25/25		▶ 5 m _____ 773 844
<b>PNOZ msi3Ap</b> Adapter Si/Ha 15/15	▶ Connection cable for all common makes of drive	▶ 2.5 m _____ 773 841
<b>PNOZ msi3Bp</b> Adapter Si/Ha 15/15		▶ 5 m _____ 773 839
<b>PNOZ msi5p</b> Adapter Bos/Rex 15/15	▶ Connection to drive and incremental encoder via 25-pin or 15-pin D-Sub male and female connector, or wired with stranded cable	▶ 2.5 m _____ 773 842
<b>PNOZ msi6p</b> Adapter Elau 9/9	▶ For more information, please refer to the operating instructions	▶ 2.5 m _____ 773 843
<b>PNOZ msi7p</b> Adapter SEW 15/15		▶ 2.5 m _____ 773 857
<b>PNOZ msi8p</b> Adapter Lenze 9/9		▶ 1.5 m _____ 773 858
<b>PNOZ msi9p</b> adapter cable		▶ 7.5 m _____ 773 859
<b>PNOZ msi19p</b> ADAPTER ELAU PACDrive3		▶ 2.5 m _____ 773 860
<b>PNOZ msi b1 Box 9p</b>	▶ Adapter box for PNOZ msxp speed monitoring modules PNOZmulti	▶ 1.5 m _____ 773 861
<b>PNOZ msi b1 Box 15p</b>	▶ x-pin D-Sub male connector/female connector, 2 x female, 1 x male	▶ 2.5 m _____ 773 864
<b>PNOZ msi b1 Box 25p</b>		▶ 1.5 m _____ 773 865
<b>PNOZ msi S09</b>	▶ Connector sets/adapters for connecting frequency converters to speed monitors PNOZ msxp, PNOZ s30, PNOZ m EF 1MM/2MM, adapter box PNOZ msi b1 Box	▶ 2.5 m _____ 773 862
<b>PNOZ msi S15</b>	▶ Plug-in connector X1/X2: x-pin D-Sub male connector/female connector	▶ 1.5 m _____ 773 863
<b>PNOZ msi S25</b>		▶ 5.0 m _____ 773 856
<b>PNOZ msi9p</b>	▶ Connection cable for adapter box PNOZ msi b1 Box	▶ 2.5 m _____ 773 854
<b>PNOZ msi10p</b>	▶ Connection via RJ45 connector, stranded wire cables with wire end ferrules	▶ 1.5 m _____ 773 855
<b>PNOZ msi11p</b>		▶ 2.5 m _____ 773 847
<b>PNOZ msi b0 cable 15/RJ45</b>	▶ For adapter box PNOZ msi b1 Box	▶ 1.5 m _____ 773 848
<b>PNOZ msi b0 cable 25/RJ45</b>	▶ x-pin D-Sub male connector/ 8-pin RJ45 connector	▶ 2.5 m _____ 773 854
<b>MM A MINI-IO-CAB</b>	▶ Adapter cable for PNOZmulti 2, PNOZ m EF 1MM and PNOZ m EF 2MM ▶ Shielded ▶ Preassembled 8-pin Mini IO male connector at one end	▶ 25-pin, 2.5 m _____ 773 884
		▶ 1.5 m _____ 772 200
		▶ 2.5 m _____ 772 201
		▶ 5.0 m _____ 772 202

Webcode:  
web87010

Online information  
at [www.pilz.com](http://www.pilz.com)

## ► Decentralized modules PDP67

With the PDP67 modules you can achieve a high level of decentralization. The digital input module PDP67 F 8DI ION forwards signals from the sensors connected decentrally in the field to various evaluation devices, e.g. PNOZmulti 2, PNOZmulti Mini and PNOZmulti. Using the PDP67 modules up to 64 sensors can be connected to the analysis units.



PDP67 F 8DI ION

### Decentralized and passive – decentralized safety

The passive junction PDP67 F 4 code enables the connection of up to four sensors PSEnlock or PSEnini. In addition to the possibility of connection to the configurable control systems PNOZmulti, PNOZmulti Mini and PNOZmulti 2, the PNOZsigma safety relays are also available.

Versatile automation architectures are possible due to the possibility of connection to various evaluation devices.

### PDP67 – economical and safe

Integrated into dirt and water-repellent IP67 housings, the PDP67 modules can even be used where there are high demands on hygiene. The decentralized modules optimize the installation and wiring effort – saving you time, money and space in the control cabinet. PDP67 modules with stainless steel threads satisfy the requirements of the food industry.

### Type code for decentralized modules PDP67

PDP67 F 8DI ION HP VA

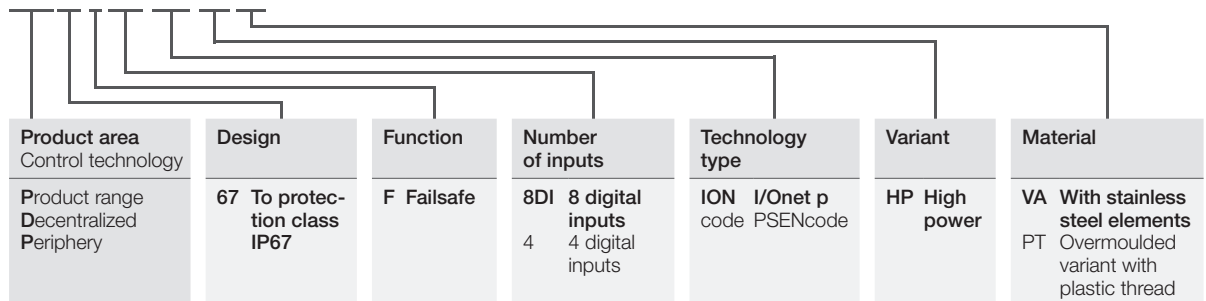

Keep up-to-date on decentralized modules PDP67:

Webcode:  
web150510

Online information at [www.pilz.com](http://www.pilz.com)



PDP67 F 8DI ION PT

**New decentralized input module  
PDP67 F 8DI ION PT**

Thanks to an improved manufacturing process, the new decentralized input module is a cost-effective alternative to existing solutions on the market. This new addition to the range of Pilz decentralized field devices allows modular machine concepts to be planned and implemented with ease.

**Your benefits at a glance**

- ▶ Less planning and design work thanks to simple installation
- ▶ Simple implementation of a modular machine concept
- ▶ Saving of space in the control cabinet
- ▶ Integrated in dirt and water-repellent housings
- ▶ Can be used for applications with high demands on hygiene

**Technical details – modules for alternative connection options for sensors**



PDP67 F 4 code



PDP67 Connector cs

Type	Features	Safety	Certification	Order number
PDP67 F 8DI ION	Decentralized input module for PNOZmulti 2, PNOZmulti Mini and PNOZmulti	<ul style="list-style-type: none"> <li>▶ PL e of EN ISO 13849-1</li> <li>▶ SIL CL 3 of EN/IEC 62061</li> </ul>	BG, CE, TÜV, cULus Listed	773 600
PDP67 F 8DI ION VA			BG, CE, TÜV, cULus Listed	773 614
PDP67 F 8DI ION PT			BG, CE, cULus Listed	773 616
PDP67 F 8DI ION HP	Decentralized input module for <ul style="list-style-type: none"> <li>▶ PNOZmulti 2, PNOZmulti Mini and PNOZmulti</li> <li>▶ High power</li> <li>▶ Additional supply voltage for PSEnslock and PSEnopt</li> </ul>		BG, CE, TÜV, cULus Listed	773 601
PDP67 F 8DI ION HP VA			BG, CE, TÜV, cULus Listed	773 615
PDP67 F 4 code	Passive junction PSEncode		CE, cULus Listed	773 603
PDP67 F 4 code VA			CE, cULus Listed	773 613
PDP67 Connector cs	Adapter for connection cable to the evaluation device	-	-	773 610
PDP67 Connector cs VA			-	773 612

## ► Cable navigator

The cable navigator helps in the creation of your application. It provides a fast, simple overview of which cable and which adapter can be used to connect to the respective analysis unit and on various sensors.

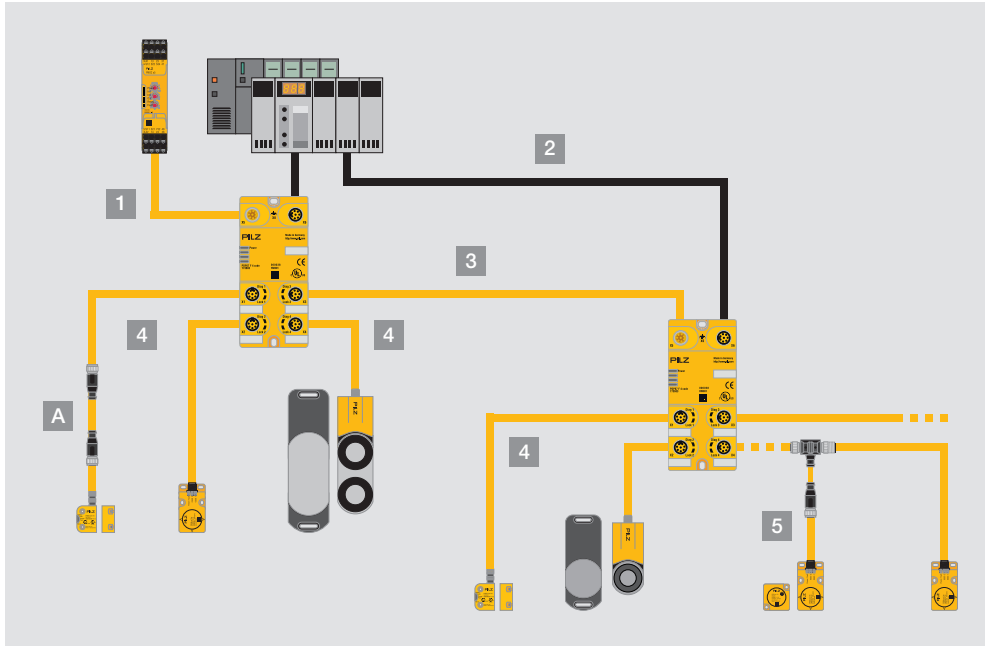

Use of cables for an application with PDP67 F 4 code.

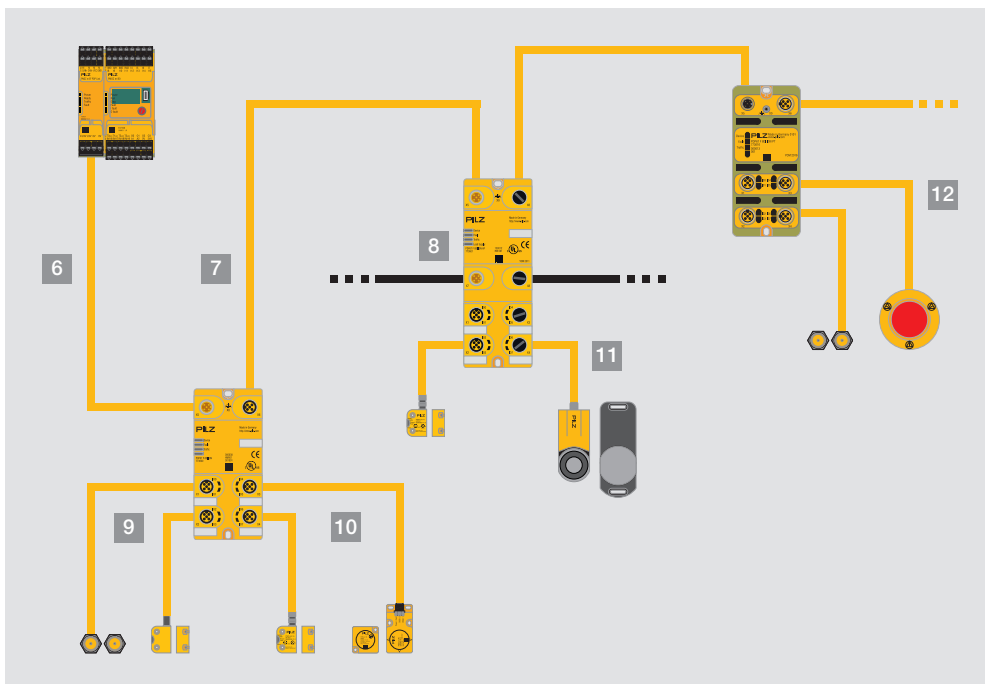

Use of cables for an application with PDP67 F 8DI ION.

### Cable navigator

#### Type

- |    |  |
|----|--|
| A  | Adapter for M8 connection, 8-pin sensors                               |
| 1  | Connection cable evaluation device – PDP67 (X5)                        |
| 2  | Connection cable standard evaluation device – PDP67 (X6)               |
| 3  | Connection cable PDP67 (X1–X4) – PDP67 (X5)                            |
| 4  | Connection cable PSENcode, PSENslock, PSENini (X1–X4)                  |
| 5  | PSEN Y-junction/PSEN T-junction for series connection                  |
| 6  | Connection cable PNOZ m EF PDP Link/PNOZ ml2p/ PNOZ mml2p – PDP67 (X5) |
| 7  | Connection cable PDP67 (X6) – PDP67 (X5)                               |
| 8  | Supply cable PDP67 F 8DI ION HP (X7–X8)                                |
| 9  | Connection cable PSENmag (X1–X4)                                       |
| 10 | Connection cable PSENcode (X1–X4)                                      |
| 11 | Connection cable PSENslock (X1–X4)                                     |
| 12 | Connection cable PIT, sensors without M12 connection (X1–X4)           |

Features	Certification	Order number	Order number						
			2 m	3 m	5 m	10 m	20 m	30 m	
PSEnconverter, straight, M8, 8-pin, socket to M12, 8-pin, connector	UL	540329	-	-	-	-	-	-	
PSEncable, straight, M12, 8-pin, open-ended socket	UL	-	-	540319	540320	540321	540333	540326	
PDP67 cable, straight, M12, 8-pin, open-ended connector	UL	-	380700	-	380701	380702	380703	380704	
PSEncable, straight, M12, 8-pin, plug/socket	UL	-	540340	-	540341	540342	540343	540344	
PSEncable, straight, M12, 8-pin, plug/socket	UL	-	540340	-	540341	540342	540343	540344	
PSEN Y-junction M8-M12/M12, pigtail, series connection with M8, 8-pin	-	540337	-	-	-	-	-	-	
PSEN Y-junction M12-M12/M12, pigtail, series connection with M12, 8-pin	-	540338	-	-	-	-	-	-	
PSEN T-junction, M12, diagnostic connector	-	540331	-	-	-	-	-	-	
PSEN op cable, straight, M12, 5-pin, open-ended socket	UL	-	-	630310	630311	630312	630298	630297	
PSS67 cable, straight, M12, 5-pin, plug/socket	UL	-	-	380208	380209	380210	380220	380211	
X7: PSS67 supply cable, straight, M12, 5-pin, open-ended socket, B-coded	UL	-	-	380256	380257	380258	-	-	
X7-X8: PSS67 supply cable, straight, M12, 5-pin, plug/socket, B-coded	UL	-	-	380250	380251	380252	-	-	
n-type: PSS67 cable, straight, M12, 5-pin, plug/socket	UL	-	-	380208	380209	380210	380220	380211	
p-type (M8, 4-pin): PSS67 cable, straight, M8, 4-pin, socket, M12, 4-pin, connector	UL	-	-	380200	380201	380202	-	380203	
Adapter for p-type: PSEnmag adapter	-	-	380300	-	-	-	-	-	
n-type: PSS67 cable, straight, M12, 5-pin, plug/socket	UL	-	-	380208	380209	380210	380220	380211	
p-type (M12, 8-pin): PSS67 cable, straight, M12, 5-pin, plug/socket	UL	-	-	380208	380209	380210	380220	380211	
Adapter for p-type: PSEN cs adapter	-	-	380301	-	-	-	-	-	
n-type: PSS67 cable, straight, M12, 5-pin, plug/socket	UL	-	-	380208	380209	380210	380220	380211	
p-type (M12, 8-pin): PSS67 cable, straight, M12, 5-pin, plug/socket	UL	-	-	380208	380209	380210	380220	380211	
PSEN sl adapter	-	-	380325	-	-	-	-	-	
PDP67 cable, straight, M12, 5-pin, open-ended connector	UL	-	-	380705	380709	380706	380707	380708	

## ▶ PLC controllers and I/O systems

You can use controllers and decentralized I/O systems from Pilz to easily and flexibly implement safety and automation applications of any size: machines with an elementary function range, machines with multiple axes, interlinked plant and machinery. High availability and productivity, as well as maximum safety, are guaranteed for your plant and machinery.

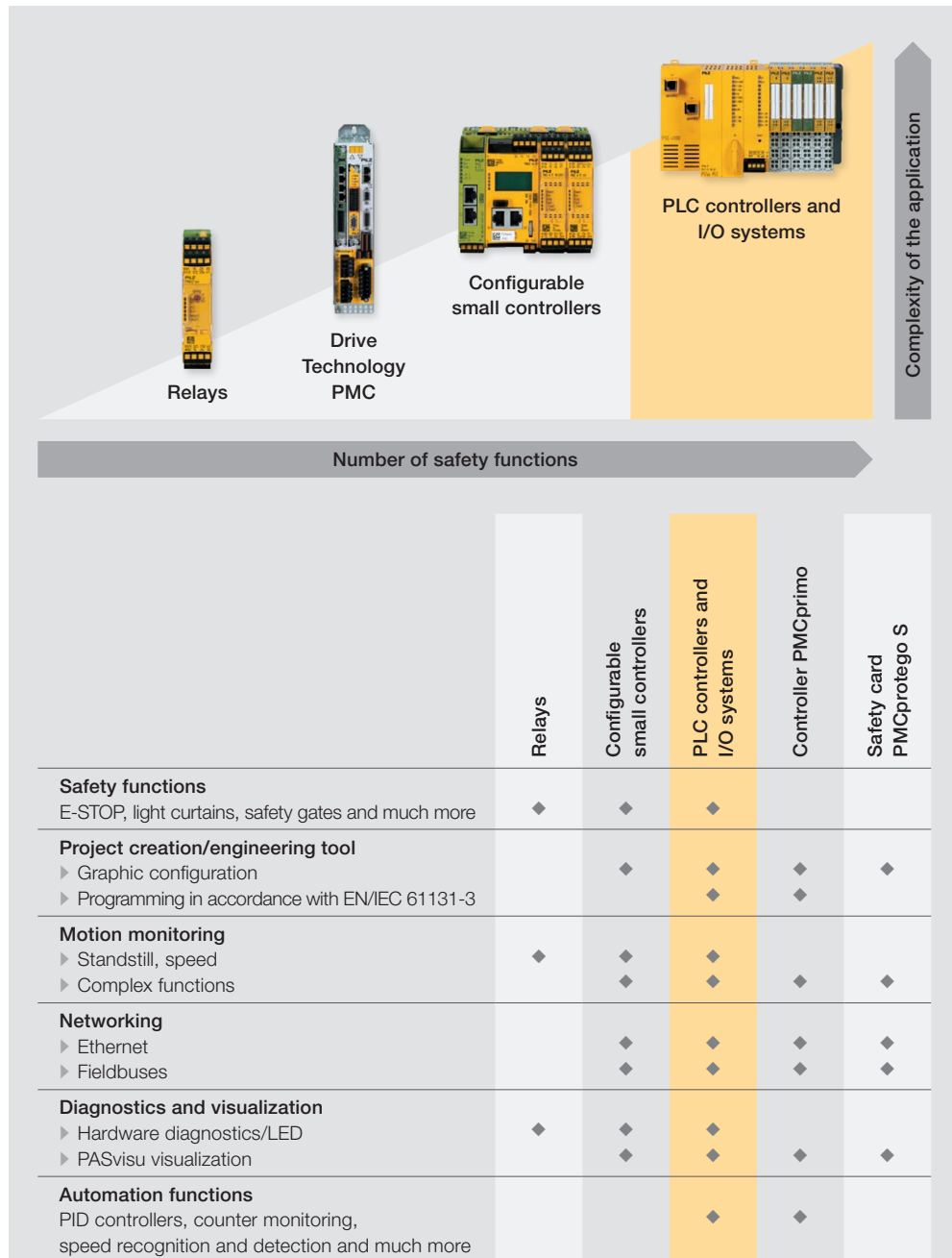





**Product range**

**PLC controllers and I/O systems**

▶ PLC controllers and I/O systems PSSuniversal	106
▶ Automation system PSS 4000	108
▶ Firewall SecurityBridge	112

**Product range**

**Decentralized I/O system PSSuniversal**

▶ Technical details	116
---------------------	-----

**Product group**

**Remote I/O system PSSuniversal 2**

▶ Technical details	136
---------------------	-----

## ► PLC controllers and I/O systems PSSuniversal

The PLC controllers and I/O systems PSSuniversal from Pilz can be used for the most diverse applications and offer maximum flexibility. Various hardware and software components for safety and automation enable different combinations for implementing your application. Openness and easy handling are key features of our systems.

### Overview of product range PSSuniversal

Head modules

Head modules with control functions



**SafetyNET p**  
Be safe about your automation

PSSu PLC

Head modules with I/O functions



**SafetyNET p**  
Be safe about your automation

PSSu I/O

Head modules with I/O functions



**PROFINET**



PSSu I/O



I/O modules

Input and output modules



Systems

Control and I/O systems of automation system PSS 4000



The automation system PSS 4000 is the optimum solution for monitoring safety-related and non-safety-related functions. The various controllers and I/O systems, combined with configuration and programming software, make the system scalable and allow it to be used in all branches of industry in existing networks with SafetyNET p or other Ethernet protocols.

PSSuniversal decentralized I/O system

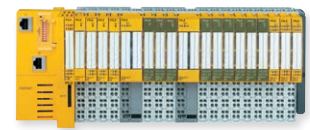

The decentralized I/O systems PSSuniversal can be tailored for use as remote I/Os at field level. Connection to a higher-level third-party controller is via common industrial communication protocols such as PROFINET/PROFIsafe. They can be configured using the PSSuniversal Assistant.

The new generation

Head modules with I/O functions



PSS u2 I/O



Input and output modules



PSSuniversal 2 remote I/O system

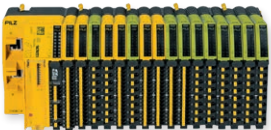

The remote I/O system PSS u2 is the new generation of universal systems. Connection to a higher-level third-party controller is via common industrial communication protocols such as PROFINET/PROFIsafe and EtherNet/IP, CIP Safety. Thanks to technical and mechanical improvements users benefit from time and cost savings.

Easy to configure!

With PSSuniversal you can monitor and control safety-related and non-safety-related functions on your plant. Both worlds merge together intelligently. So that the safety of human and machine is guaranteed at all times, the system fulfils the requirements for absence of feedback and enables extremely short reaction times. This ensures that changes or expansions in the control section have no influence on safety. PSSuniversal therefore complies with EN/IEC 61508 up to SIL 3 and EN ISO 13849 up to PL e. The PSSu I/O decentralized I/O systems are connected to a higher-level controller PSSuniversal PLC via SafetyNET p.

Your benefits at a glance

- ▶ Processing of safety and automation functions
- ▶ Modular system structure for maximum flexibility
- ▶ Extensive selection of modules to meet your specific requirements
- ▶ Ready for use in a variety of applications
- ▶ Digital and analog value processing
- ▶ Fast installation, fast module change even during operation
- ▶ Greater energy efficiency thanks to intelligent system design
- ▶ Functions comply with the international standards for machine safety
- ▶ Simple handling thanks to easily understandable software



Keep up-to-date on PLC controllers and I/O systems:

Webcode: web150509

Online information at [www.pilz.com](http://www.pilz.com)

## ► PLC controllers for more safety



Are you looking for a safe and easy way to automate your plant or machinery? As the heart of the automation system PSS 4000, our PLC controllers in protection types IP20 and IP67 monitor safety-related as well as non-safety-related functions in one system! The automation system PSS 4000 can be customized according to your specific needs. You choose the combination of PLC controllers and numerous I/O modules that you need for the safety of your plant. The engineering software PAS4000 and the visualization software PASvisu complete the system.



### Your benefits at a glance

- One system for the entire automation technology
- Merging safety and automation
- Solution for Industrie 4.0
- Distribution of control functions according to the multi-master principle
- Easy programming and configuration with the PAS4000 software
- Web-based visualization with the PASvisu software
- Safe communication via real-time Ethernet SafetyNET p
- High level of flexibility thanks to modular system structure
- Can be used in all branches
- Special approvals for use for railway and lifts/escalators
- Can be integrated into existing automation structures



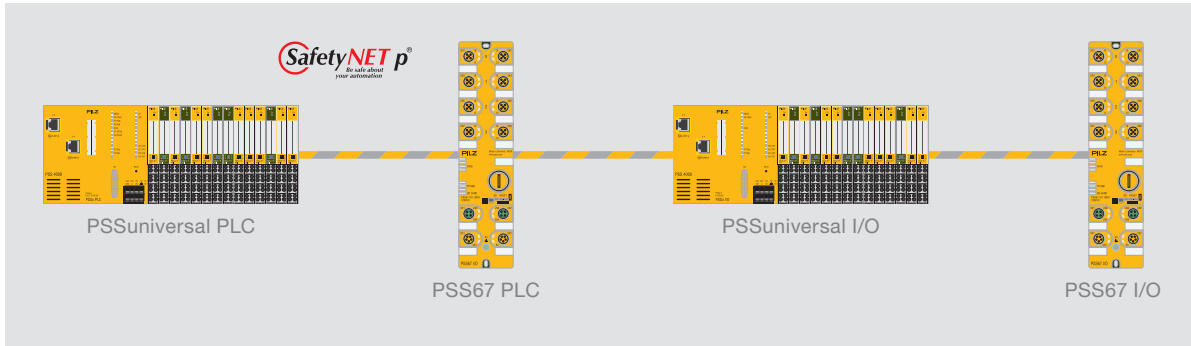

**For your control cabinet: PSSuniversal PLC**

PLC controllers PSSuniversal PLC are all-rounders in the automation system PSS 4000. You can use them as a “classical” central PLC for safety and automation or as a distributed system. They can be configured and programmed in the main languages defined in EN/IEC 61131-3.

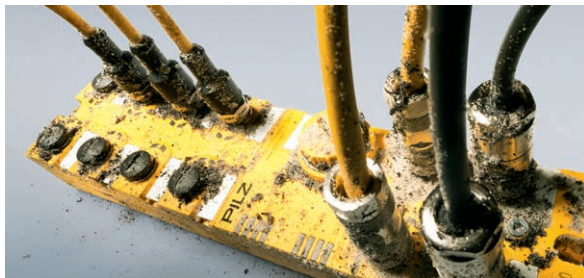

**Outside the control cabinet: PSS67 PLC**

The PLC controller PSS67 PLC with protection type IP67 is responsible for control outside the control cabinet. The module electronics is fully encapsulated, meaning it can withstand dust and short-term submersion. You can program the controller PSS67 PLC as well as the IP20 controllers using the engineering software PAS4000.

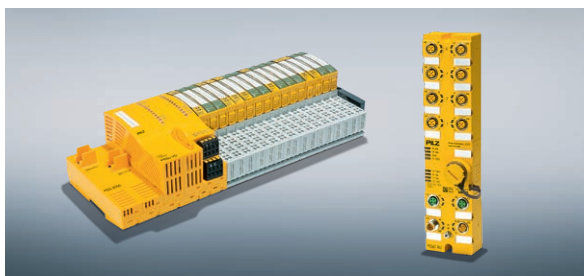

**Modifications for the field level**

The modules PSSuniversal I/O and PSS67 I/O are used for decentralized networking and transfer of safety-related and non-safety-related signals at field level. PSSuniversal I/O enables a wide range of applications to be implemented by connecting up to 64 I/O modules. The I/O block PSS67 with its protection type IP67 is ideal for installation without a control cabinet!

Keep up-to-date on the automation system PSS 4000:

Webcode: web151338

Online information at [www.pilz.com](http://www.pilz.com)

PLC controllers and I/O systems



### Firewall SecurityBridge – protect your controller

With the firewall SecurityBridge you protect the automation system PSS 4000, for example, against manipulation through unauthorized access. It is connected upstream of the PLC controller PSSuniversal PLC and functions as a VPN server. This banishes the specter of espionage and manipulation, and guarantees the safety of your employees and the availability of your machinery! For more information, see page 112.



### Engineering software PAS4000 – simple programming

With PAS4000 you can create programs for safety and automation quickly and intuitively using just one interface. You can choose between the graphics program editor PASmulti or the programming languages in accordance with EN/IEC 61131-3: PAS STL (Structured Text), PAS LD (Ladder Diagram) and PAS IL (Instruction List). The comprehensive library of safety-related and non-safety-related software blocks make creating automation programs easy.

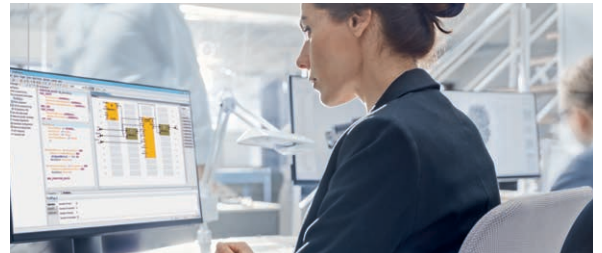

### Visualization software PASvisu – easy overview

The PASvisu web-based visualization software allows you to keep a close eye on the automation system PSS 4000: both locally and by remote access. You can link PASvisu directly to the control project from the software PAS4000. In this way, you benefit from shorter project runtimes, faster engineering and reduced potential for error. Further information on PASvisu is available on page 182.



### Real-time-Ethernet SafetyNET p – Pure communication

In addition to the connection to communication networks such as EtherNet/IP, EtherCAT, Modbus TCP, PROFINET and PROFIBUS-DP, the controllers PSSuniversal PLC also have a SafetyNET p communication interface. SafetyNET p is the backbone of the whole system. Various infrastructure components such as switches allow the network to be adapted to the plant structure. Gateways are also available to connect to various third-party controllers.

**More intelligence with the multi-master design**

Automation of the future requires solutions that can distribute control intelligence and are still easy to use. The automation system PSS 4000 makes this possible. Multiple controllers with identical authorization rights are connected simply via the real-time Ethernet SafetyNET p. SafetyNET p exchanges data and state information between the controllers and synchronizes it. In PAS4000, you program and configure all network subscribers centrally. That makes handling your project really simple, however large it is!



Webcode:  
web150609

Online information  
at [www.pilz.com](http://www.pilz.com)

**Safety for rail transport**

We developed the automation system PSS 4000 as a R(ail) variant specifically for railway technology. It corresponds to the specifications from CENELEC and is robust against electromagnetic interference, extreme temperatures and mechanical loads. It enables a clear path for safe railway applications up to SIL 4!

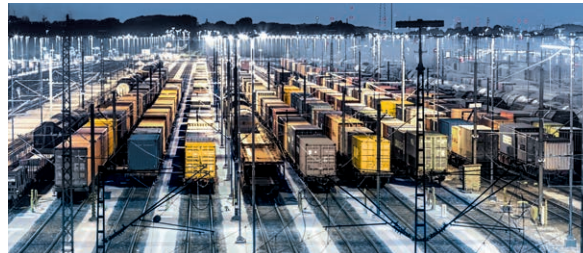

Webcode:  
web8485

Online information  
at [www.pilz.com](http://www.pilz.com)

**Safety despite high temperature fluctuations**

For harsh environments and high temperature fluctuations, we offer the automation system as a T(emperature) variant. The specified operating temperature range is from  $-40\text{ }^{\circ}\text{C}$  to  $+70\text{ }^{\circ}\text{C}$ . In addition, the modules are protected against condensation in compliance with pollution degree 2. This variant is suitable for applications such as wind turbines and cable cars. In many cases, using these modules means there is no need for additional climate control measures, reducing costs considerably.



## ► Firewall SecurityBridge

If people, machinery and industrial processes are intelligently linked, they are also more susceptible to attack. So how do you protect your controllers against manipulation? We offer you the optimum solution with the SecurityBridge! The SecurityBridge protects controllers from manipulation and unauthorized access.



PCOM ser br1

We as a supplier of safe automation solutions are committed to the protection of people against dangers arising from a machine (functional safety) as well as protection of the machinery against people (industrial security). For this reason, we have developed our firewall, the SecurityBridge, using a secure development process in accordance with the standard IEC 62443-4-1 and had it certified by TÜV Süd in combination with IEC 62443-3-3.

### The firewall SecurityBridge protects against:

- Unauthorized access by monitoring the communication
- Manipulation through authentication and permission management
- Unauthorized changes by monitoring projects of the control and automation systems from Pilz

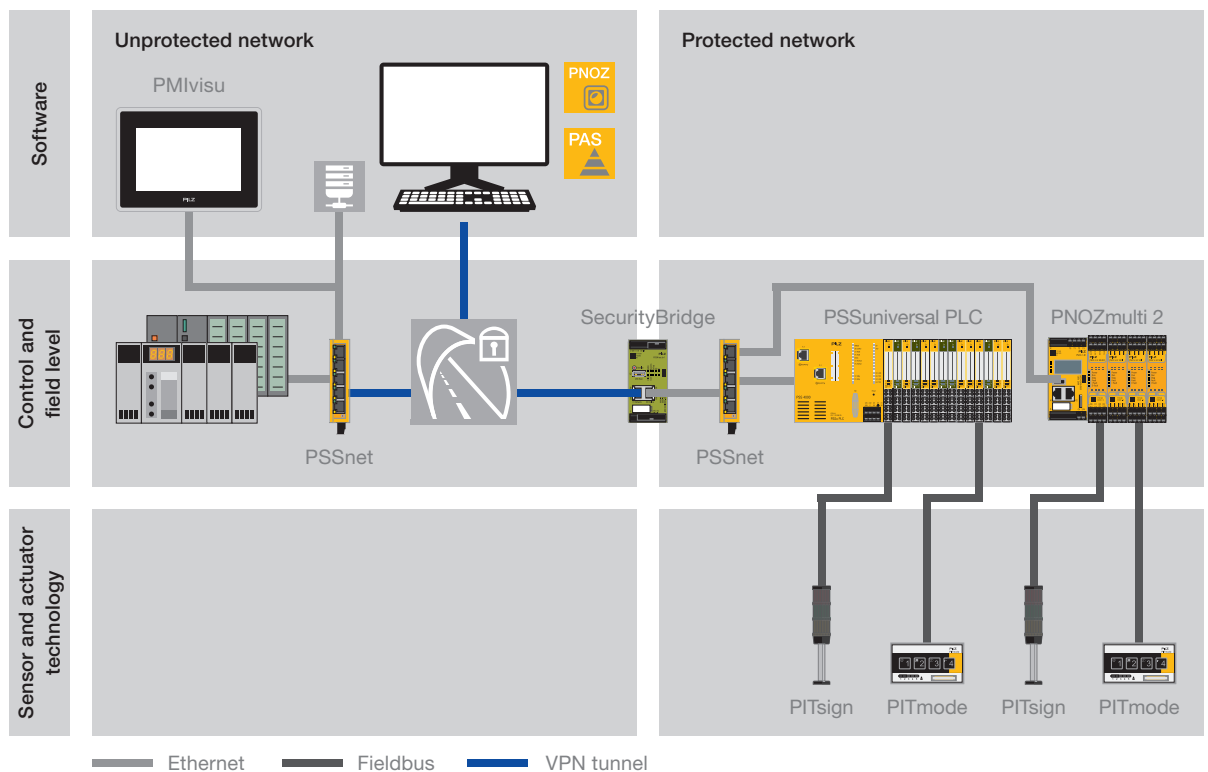

Webcode:  
web188268

Online information  
at [www.pilz.com](http://www.pilz.com)

The SecurityBridge prevents unauthorized access to its downstream devices.



### Package filtering

The firewall SecurityBridge monitors the communication between controllers to be protected and the programming and visualization PCs or service computers. It functions as a package filter: only necessary data (authorized configuration and process data) is transmitted. The SecurityBridge can thus be easily integrated into existing plants. Due to its unique design, it offers the option of rapid forwarding of process data with minimum latency. This is particularly advantageous for applications with time-critical process data.



User management via the SecurityBridge web server.

### User management

To ensure that controller project data is protected against manipulation or incorrect operation, only authorized personnel with the corresponding training and instruction is allowed access to the controllers. The SecurityBridge web server can be used as a central authentication server for this purpose. In addition to the user name and password, the role of the employee is also defined there. This ensures that only authorized persons are given access to the protected product.

### Protected access via VPN

To ensure that authenticated personnel can safely exchange data with a system, the SecurityBridge offers a standardized VPN solution. As a result a service PC can be part of the protected network. To accomplish this, a VPN client on the service PC establishes an encrypted connection to the firewall. Authentication is performed in the next step. A check is performed here as to which person on which devices is allowed access to the protected zone and if so, with which permissions.

### Your benefits at a glance

- ▶ TÜV SÜD-certified and developed in accordance with IEC 62443-4-1 and IEC 62443-3-3
- ▶ Protection against manipulation of data through authentication and authorization management
- ▶ Increases plant availability because only required data (authorized configuration and process data) is transferred
- ▶ Forwarding of low-latency process data
- ▶ Reveals unauthorized changes to the project by monitoring the check sum (CRC)
- ▶ Prevents unauthorized access because downstream devices are in a protected network
- ▶ Only suitably authorized users can make changes to a project's configuration



### An all-round safe solution

It is also possible to combine this with our operating mode selection and access permission system PITmode fusion in order to utilize another factor for two-factor authentication.

Webcode:  
web150439

Online information  
at [www.pilz.com](http://www.pilz.com)

## ▶ Decentralized I/O system PSSUniversal

The decentralized I/O system PSSUniversal allows you to perform safety-related and automation functions at field level. Communication with the control level takes place via common fieldbus protocols. Here all sensor and actuator signals are connected to one module. This ensures clear cabling and avoids errors during installation.

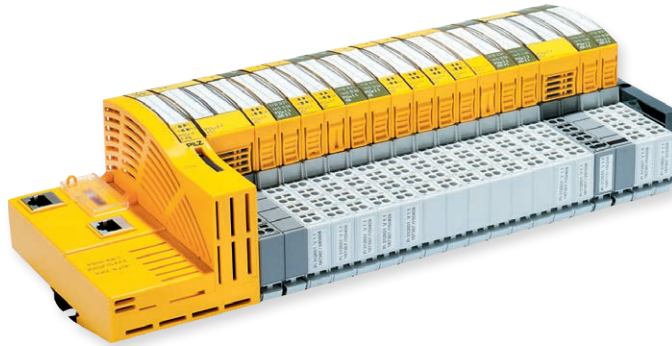

### Your benefits at a glance

- ▶ Processing of safety-related and automation functions decentrally at field level
- ▶ Reduction of switching times
- ▶ Optimum availability thanks to safe block switching
- ▶ Fast commissioning and easy configuration thanks to the independent periphery test

The decentralized I/O systems can be connected to different higher-level controllers as a cost-effective variant of a remote I/O system. The PSSUniversal system is therefore a solution for connecting periphery and safety-related functions to a central controller.

### Safe block switching of individual plant sections

Safe block switching is used to shut down the supply voltage to a group of standard outputs (e.g. several motors) if a hazardous event occurs. When a hazardous event does occur (e.g. an E-STOP pushbutton is pressed), safe block switching ensures safe shutdown of a complete plant section while other sections can continue to operate.



**Simple configuration,  
fast commissioning**

The decentralized I/O systems are configured using the PSSUniversal Assistant. Thanks to the PSSUniversal Startup Tool, the system can be commissioned quickly. You can already perform the first cable and function tests before the plant or machine is set up. That way all of the periphery is already tested and functional when you come to commission the plant. Commissioning operations can be carried out independently and simultaneously – reducing dependencies and saving time!

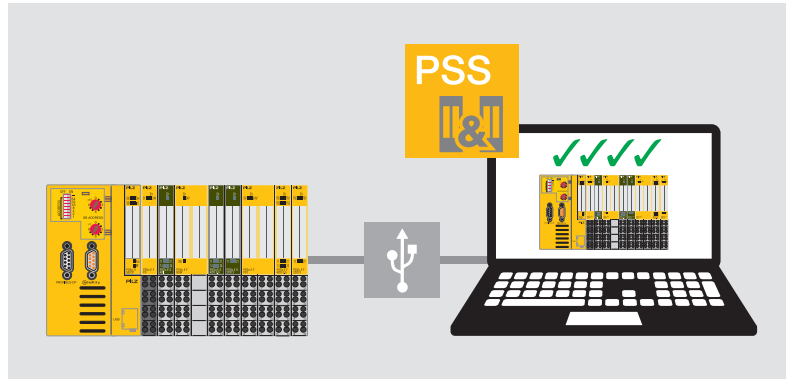

Cable and function tests performed easily via the USB port on the notebook.

**PSSUniversal –  
also for PROFINET users**

Optimized address management on the PROFINET versions of the decentralized I/O system is particularly convincing. The PROFINET/PROFIsafe address is only required once per decentralized station. This means, for example, that safety settings for each device only need to be made at a single point, i.e. in the head module. There is no need for address setting and management on each individual I/O module. As a result, the failsafe addresses are optimally utilized. This saves planning and management costs.

**PSSu Configurator**

- ▶ Called up via TCI
- ▶ Configures the system
- ▶ Generates station-specific GSDML files
- ▶ Manages all safety-related CRC sums

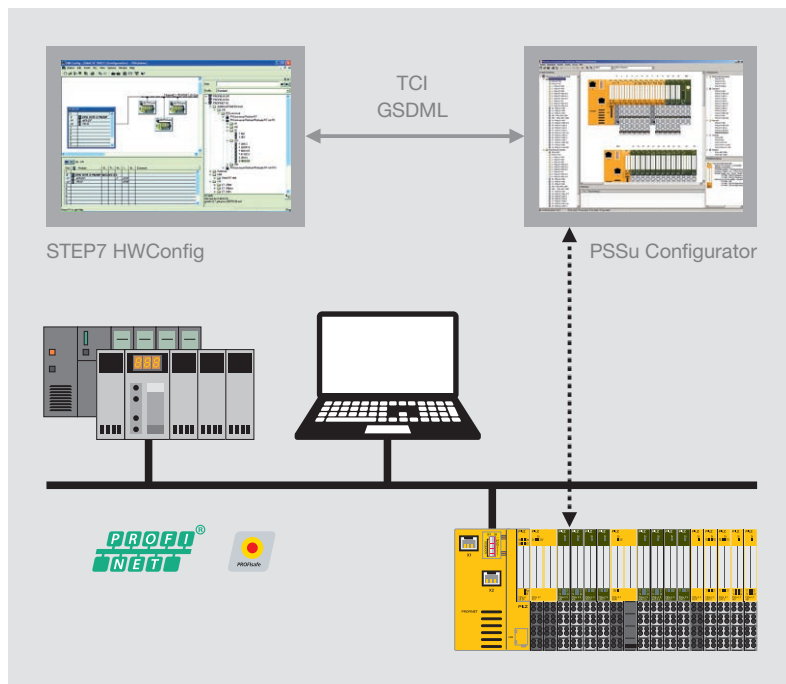

Comprehensive tool support for configuration, commissioning and diagnostics.

PLC controllers and I/O systems

## ▶ Technical details – PLC controllers and I/O systems

### Decentralized I/O system PSSuniversal – head modules



PSSu H F PN

Type	Application area		Communication interfaces
	Failsafe functions	Automation functions	
PSSu H F PN	◆	◆	<ul style="list-style-type: none"> <li>▶ 1 x PROFINET</li> <li>▶ 1 x PROFI-safe</li> </ul>
PSSu H F PN o	◆	◆	<ul style="list-style-type: none"> <li>▶ 1 x PROFINET</li> <li>▶ 1 x PROFI-safe</li> <li>▶ Fiber-optic</li> </ul>
PSSu H S PN		◆	2 x PROFINET

### Automation system PSS 4000 – head modules with control and I/O function



PSSuniversal PLC



PSSuniversal I/O

Type	Application area		Communication interfaces
	Failsafe functions	Automation functions	
▶ PSSuniversal PLC			
PSSu H PLC1 FS SN SD	◆	◆	2 x SafetyNET p
PSSu H PLC1 FS DP SN SD	◆	◆	<ul style="list-style-type: none"> <li>▶ SafetyNET p</li> <li>▶ PROFIBUS-DP (slave, DPV0)</li> </ul>
PSS67 PLC1 16FDI	◆	◆	2 x SafetyNET p
▶ PSSuniversal I/O			
PSSu H FS SN SD	◆	◆	2 x SafetyNET p
PSS67 IO1 16FDI	◆	◆	2 x SafetyNET p

#### Common features

- ▶ PSSuniversal module bus for connection of up to 64 I/O modules for safety-related and non-safety-related functions
- ▶ Integral power supply
- ▶ Integrated switch function for SafetyNET p linear topology
- ▶ SD card to store the device project and configuration data
- ▶ International safety standards (up to SIL CL 3 of EN/IEC 61508, up to PL e of EN ISO 13849), lifts standard EN 81/2 and EN 50129
- ▶ Dimensions (H x W x D) in mm: 125.6 x 130 x 83.7

# PSSuniversal

Features	Certification	Order number		
		Regular version	T-type <sup>1)</sup>	R-type <sup>2)</sup>
<ul style="list-style-type: none"> <li>▶ PSSuniversal module bus for connection of up to 64 I/O modules for safety-related and non-safety-related functions</li> <li>▶ Dimensions (H x W x D) in mm: 128.4 x 75.2 x 79.4</li> </ul>	BG, CE, EAC, TÜV, cULus Listed	312043	-	-
	CE, EAC, TÜV, cULus Listed	312042	-	-
	CE, cULus Listed	312041	-	-

Features	Certification	Order number		
		Regular version	T-type <sup>1)</sup>	R-type <sup>2)</sup>
<ul style="list-style-type: none"> <li>▶ Can be configured using the graphics program editor PASmulti</li> <li>▶ Programming in PAS IL (instruction list), PAS LD (ladder diagram) and PAS STL (structured text) in accordance with EN/IEC 61131-3</li> <li>▶ Programming via Ethernet TCP/IP</li> <li>▶ Max. number of failsafe tasks: 9</li> <li>▶ Max. number of standard tasks: 9</li> </ul>	BG, CE, EAC (Eurasian), KOSHA, TÜV, cULus Listed	312070	314070	315070
	BG, CE, EAC (Eurasian), KOSHA, TÜV, cULus Listed	312071	-	-
<ul style="list-style-type: none"> <li>▶ 16 safe inputs with IP67 protection – suitable for use in the extended temperature range (0 °C to +70 °C)</li> </ul>	CE, TÜV	316020	-	-
<ul style="list-style-type: none"> <li>▶ Communication with other SafetyNET p devices (RTFN)</li> <li>▶ Standard module bus for standard I/O modules</li> </ul>	BG, CE, EAC (Eurasian), KOSHA, TÜV, cULus Listed	312085	314085	315085
<ul style="list-style-type: none"> <li>▶ Communication with other SafetyNET p devices (RTFN)</li> <li>▶ With IP67 protection – suitable for use in the extended temperature range (-30 °C to +70 °C)</li> </ul>	CE, TÜV	316010	-	-

<sup>1)</sup>  The modules are also available as T-type for increased environmental requirements. The order numbers of the T-type modules are 314 ... instead of 312 ...

<sup>2)</sup>  The modules are also available as R-type for railway applications. The order numbers of the R-type modules are 315 ... instead of 312 ...

PLC controllers and I/O systems

Keep up-to-date on controllers PSSuniversal and I/O systems:

 Webcode: web150509

Online information at [www.pilz.com](http://www.pilz.com)

## ► Technical details – PSSuniversal

### Supply modules, junction modules and safe block switching module



Type	Suitable for		Function	Application area		Electrical data	
	PSSuniversal – I/O system	PSSuniversal – controllers PSS 4000		Failsafe functions	Automation functions	Supply voltage	Current load capacity Module supply
PSSu E F PS	◆	◆	Power supply	◆	◆	24 VDC	Max. 1.5 A
PSSu E F PS1	◆	◆	Power supply, buffered	◆	◆	24 VDC	Max. 2.0 A
PSSu E F PS2		◆	Power supply, buffered	◆	◆	24 VDC	Max. 1.0 A
PSSu E F PS-P	◆	◆	Power supply, periphery	◆	◆	24 VDC	-
PSSu E PD	◆	◆	Voltage distribution		◆	-	-
PSSu E PD1	◆	◆	Voltage distribution		◆	-	-
PSSu E S PD-D	◆	◆	Voltage distribution		◆	-	-
PSSu E F BSW	◆		Block switching function	◆	◆	24 VDC	-
PSSu E PS-P 5 V	◆	◆	Voltage distribution		◆	24 VDC	-
PSSu E PS-P +/- 10 V	◆	◆	Voltage distribution		◆	24 VDC	-
PSSu E PS-P +/- 15 V	◆	◆	Voltage distribution		◆	24 VDC	-



PSSu E F PS



PSSu E PD

PLC controllers and I/O systems

#### Type code for PSSuniversal electronic module/supply modules

#### PSSu E F 4DI

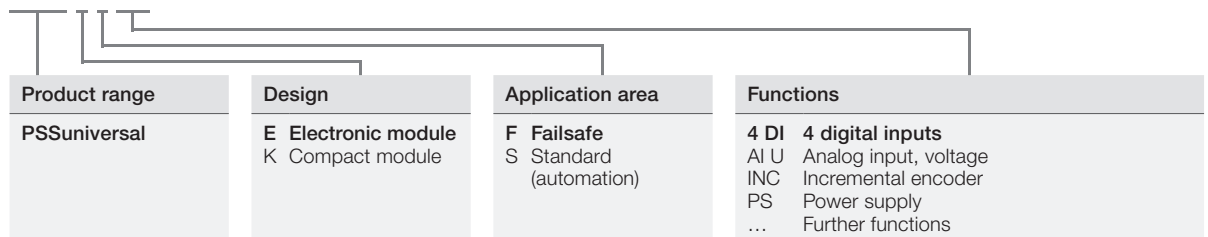



Keep up-to-date on PSSuniversal I/O modules:

Webcode:  
web150421

Online information at [www.pilz.com](http://www.pilz.com)

Current load capacity Periphery supply	Certification						Order number	Screw terminals <sup>5)</sup>										Cage clamp terminals <sup>6)</sup>																					
	BG (Federal law)	CE	EAC (Eurasian)	KOSHA	TÜV	cULus Listed		Suitable base module	Order number	PSSu BP 1/8 S <sup>3)</sup>	PSSu BP-C 1/8 S <sup>4)</sup>	PSSu BP 1/12 S	PSSu BP-C 1/12 S	PSSu BP-C1 1/12 S	PSSu BP 2/16 S	PSSu BP-C 2/16 S	PSSu BS 1/8 S	PSSu BS-R 1/8 S	PSSu BS-R 2/8 S	PSSu BS 2/8 S	PSSu BP 1/8 C <sup>3)</sup>	PSSu BP-C 1/8 C <sup>4)</sup>	PSSu BP 1/12 C	PSSu BP-C 1/12 C	PSSu BP-C1 1/12 C	PSSu BP 2/16 C	PSSu BP-C 2/16 C	PSSu BS 1/8 C	PSSu BS-R 1/8 C	PSSu BS-R 2/8 C	PSSu BS 2/8 C								
																																312600	312610	312618	312620	312622	312628	312630	312650
Max. 10 A	◆	◆	◆	◆	◆	◆	◆	◆								◆	◆																						
Max. 10 A	◆	◆	◆	◆	◆	◆	◆											◆	◆														◆	◆					
Max. 10 A	◆	◆	◆	◆	◆	◆	◆										◆																	◆	◆				
Max. 10 A	◆	◆	◆	◆	◆	◆	◆									◆																							
-		◆				◆		◆	◆	◆		◆								◆	◆	◆	◆																
-		◆				◆																					◆	◆											
-		◆				◆		◆	◆	◆		◆								◆	◆	◆	◆																
Max. 8 A		◆	◆	◆	◆	◆													◆																		◆		
-	◆	◆				◆	◆		◆		◆		◆							◆			◆	◆															
-	◆	◆				◆	◆		◆		◆		◆							◆			◆	◆															
-	◆	◆				◆	◆		◆		◆		◆							◆			◆	◆															

 <sup>1)</sup> The modules are also available as T-type for increased environmental requirements. The order numbers of the T-type modules are 314 ... instead of 312 ...

 <sup>2)</sup> The modules are also available as R-type for railway applications. The order numbers of the R-type modules are 315 ... instead of 312 ...

<sup>3)</sup> Without C-rail

<sup>4)</sup> With C-rail

<sup>5)</sup> Shield terminal available (312963)

<sup>6)</sup> Shield terminal available (312964)

## ► Technical details – PSSuniversal

### Digital inputs and outputs



PSSu E F 4DI



PSSu E S 4DI

Type	Suitable for		Function	Application area	
	PSSuniversal – I/O system	PSSuniversal – controllers PSS 4000		Failsafe functions	Automation functions
PSSu E F 4DI	◆	◆	4 digital inputs	◆	
PSSu E F 4DO 0.5	◆	◆	4 digital outputs	◆	
PSSu E F 2DO 2	◆	◆	2 digital outputs	◆	
PSSu E F DI OZ 2	◆	◆	1 digital input, 1 digital output	◆	
PSSu E F 2DOR 8	◆	◆	2 relay outputs	◆	
PSSu K F FCU		◆	12 digital inputs, 2 digital outputs (1-pin), 2 digital outputs (2-pin), Fast Control Unit	◆	
PSSu K F FAU P		◆	4 digital inputs, 2 digital outputs	◆	
PSSu K F FAU B		◆	4 digital inputs, 2 digital outputs	◆	
PSSu E S 4DI	◆	◆	4 digital inputs		◆
PSSu E S 4DO 0.5	◆	◆	4 digital outputs		◆
PSSu E S 2DO 2	◆	◆	2 digital outputs		◆
PSSu E S 2DOR 10	◆	◆	2 relay outputs		◆
PSSu E S 2DOR 2	◆	◆	2 relay outputs		◆
PSSu K S 8DI 8DO 0.5	◆	◆	8 digital inputs, 8 digital outputs		◆
PSSu K S 16DI	◆	◆	16 digital inputs		◆
PSSu K S 16DO 0.5	◆	◆	16 digital outputs		◆

#### Common features

- Supply voltage from module supply: 5 VDC
- Potential isolation

Keep up-to-date  
on PSSuniversal  
I/O modules:

Webcode:  
web150421

Online information  
at [www.pilz.com](http://www.pilz.com)



Electrical data  Feature Inputs Outputs	Certification					Order number		Screw terminals <sup>5)</sup>					Cage clamp terminals <sup>6)</sup>					
	BG (Federal law)	CE	EAC (Eurasian)	KOSHA	TÜV	cULus Listed	Regular version	Diagnostic modules (-D)	Suitable base module	Order number								
-	◆	◆	◆	◆	◆	◆	312200 <sup>1)</sup>	-		PSSu BP 1/8 S <sup>3)</sup>	312600							
0.5 A	◆	◆	◆	◆	◆	◆	312210 <sup>1), 2)</sup>	-		PSSu BP-C 1/8 S <sup>4)</sup>	312610							
2 A	◆	◆	◆	◆	◆	◆	312215 <sup>1), 2)</sup>	-		PSSu BP 1/12 S	312618							
1 (2 A), 2-pin 1 test pulse output	◆	◆	◆	◆	◆	◆	312220 <sup>1), 2)</sup>	-		PSSu BP-C 1/12 S	312620							
2 N/O AC1: 250 V/8 A; 2 000 V DC1: 24 V/8 A	◆	◆	◆	◆	◆	◆	312225 <sup>1), 2)</sup>	-		PSSu BP-C1 1/12 S	312622							
- 2 (2 A) 1-pin 2 (2 A) 2-pin		◆	◆	◆	◆	◆	312435	-		PSSu BP 2/16 S	312628							
2 (3 A) 2-pin		◆	◆		◆	◆	312421	-		PSSu BP-C 2/16 S	312630							
2 (1.75 A) 1-pin		◆	◆		◆	◆	312420	-		PSSu BP 1/8 C <sup>3)</sup>	312601							
-	◆	◆			◆	◆	312400 <sup>1), 2)</sup>	312401		PSSu BP-C 1/8 C <sup>4)</sup>	312611							
0.5 A	◆	◆			◆	◆	312405 <sup>1)</sup>	312406 <sup>1)</sup>		PSSu BP 1/12 C	312619							
2 A	◆	◆			◆	◆	312410 <sup>1)</sup>	312411 <sup>1)</sup>		PSSu BP-C 1/12 C	312621							
2 N/O	◆	◆			◆	◆	312510 <sup>1)</sup>	-		PSSu BP-C1 1/12 C	312623							
2 N/O		◆			◆	◆	312511 <sup>1)</sup>	-		PSSu BP 2/16 C	312629							
0.5 A		◆	◆		◆	◆	312431 <sup>1)</sup>	-		PSSu BP-C 2/16 C	312631							
-		◆	◆		◆	◆	312430	-										
0.5 A		◆	◆		◆	◆	312432	-										

<sup>1)</sup>  The modules are also available as T-type for increased environmental requirements. The order numbers of the T-type modules are 314 ... instead of 312 ...

<sup>2)</sup>  The modules are also available as R-type for railway applications. The order numbers of the R-type modules are 315 ... instead of 312 ...

<sup>3)</sup> Without C-rail

<sup>4)</sup> With C-rail

<sup>5)</sup> Shield terminal available (312963)

<sup>6)</sup> Shield terminal available (312964)

## ► Technical details – PSSuniversal

### Analog inputs and outputs



PSSu E S 4AO U

Type	Suitable for		Function	Application area	
	PSSuniversal – I/O system	PSSuniversal – controllers PSS 4000		Failsafe functions	Automation functions
PSSu E S 2AI U	◆	◆	2 analog inputs		◆
PSSu E S 4AI U	◆	◆	4 analog inputs		◆
PSSu E S 2AI I s.e.	◆	◆	2 analog inputs		◆
PSSu E S 2AO U	◆	◆	2 analog outputs		◆
PSSu E S 4AO U	◆	◆	4 analog outputs		◆
PSSu E S 2AO I	◆	◆	2 analog outputs		◆
PSSu E S 2AI RTD	◆	◆	2 analog inputs		◆
PSSu E S 2AI TC	◆	◆	2 analog inputs		◆
PSSu E F AI I		◆	1 analog input	◆	
PSSu E F AI U		◆	1 analog input	◆	
PSSu E AI SHT1	◆	◆	1 analog input, 2 analog outputs	◆	◆
PSSu E AI SHT2	◆	◆	1 analog input, 2 analog outputs	◆	◆

Keep up-to-date  
on PSSuniversal  
I/O modules:

Webcode:  
web150421

Online information  
at [www.pilz.com](http://www.pilz.com)

Electrical data  Feature Inputs Outputs	Certification					Order number	Screw terminals <sup>5)</sup>										Cage clamp terminals <sup>6)</sup>										
	BG (Federal law)	CE	EAC (Eurasian)	KOSHA	TÜV		cULus Listed	Suitable base module	Order number	312600	312610	312602	312612	312618	312620	312622	312628	312630	312601	312611	312603	312613	312619	312621	312623	312629	312631
0 ... 10 V s.e.; diff; -10 ... +10 V	◆				◆	◆		◆	◆			◆	◆					◆	◆			◆	◆				
0 ... 10 V s.e.	◆					◆		◆	◆			◆	◆					◆	◆			◆	◆				
0 ... 20 mA; 4 ... 20 mA	◆				◆	◆		◆	◆			◆	◆					◆	◆			◆	◆				
0 ... 10 V; -10 ... +10 V	◆				◆	◆		◆	◆			◆	◆					◆	◆			◆	◆				
0 ... 10 V	◆					◆		◆	◆			◆	◆					◆	◆			◆	◆				
0 ... 20 mA; 4 ... 20 mA	◆					◆		◆	◆			◆	◆					◆	◆			◆	◆				
-	◆				◆	◆		◆	◆			◆	◆					◆	◆			◆	◆				
Thermocouples	◆				◆	◆				◆	◆									◆	◆						
0 ... 25 mA	◆							◆	◆			◆	◆					◆	◆			◆	◆				
-10 ... +10 V	◆							◆	◆			◆	◆					◆	◆			◆	◆				
0 ... 0.6 A; 0 ... 20 mA	◆	◆			◆	◆		◆	◆			◆	◆									◆	◆				
0 ... 0.2 A; 0 ... 20 mA	◆					◆		◆	◆			◆	◆					◆	◆			◆	◆				

<sup>1)</sup>  The modules are also available as T-type for increased environmental requirements. The order numbers of the T-type modules are 314 ... instead of 312 ...

<sup>2)</sup>  The modules are also available as R-type for railway applications. The order numbers of the R-type modules are 315 ... instead of 312 ...

<sup>3)</sup> Without C-rail

<sup>4)</sup> With C-rail

<sup>5)</sup> Shield terminal available (312963)

<sup>6)</sup> Shield terminal available (312964)

## ► Technical details – PSSuniversal

### Counter modules



PSSu E S INC

Type	Suitable for		Function	Application area	
	PSSuniversal – I/O system	PSSuniversal – controllers PSS 4000		Failsafe functions	Automation functions
PSSu E S ABS SSI	◆	◆	Absolute encoder SSI		◆
PSSu E S INC	◆	◆	Incremental encoder		◆
PSSu E S INC 24V se	◆	◆	Incremental encoder		◆
PSSu E F ABS SSI		◆	Absolute encoder SSI	◆	
PSSu E F INC		◆	Incremental encoder	◆	
PSSu K F INC		◆	Incremental encoder	◆	
PSSu K F EI		◆	Encoder interface	◆	
PSSu K F EI CV		◆	Encoder interface	◆	

### Electronic modules with serial interface



PSSu E S RS232

PSSu E S RS232	◆	◆	RS232 interface		◆
PSSu K S RS232		◆	RS232 interface		◆
PSSu K S RS232 Modbus ASCII		◆	RS232 interface		◆
PSSu E S RS485	◆	◆	RS485 interface		◆

Keep up-to-date on PSSuniversal I/O modules:

Webcode:  
web150421

Online information at [www.pilz.com](http://www.pilz.com)

Electrical data	Certification					Order number	Screw terminals <sup>5)</sup>										Cage clamp terminals <sup>6)</sup>											
	Feature	BG (Federal law)	CE	EAC (Eurasian)	KOSHA		TÜV	cULus Listed	Suitable base module	Order number	312600	312610	312602	312612	312618	312620	312622	312628	312630	312601	312611	312603	312613	312619	312621	312623	312629	312631
SSI		◆				◆		PSSu BP 1/8 S <sup>3)</sup>	312600	◆	◆			◆		◆			◆	◆		◆						
INC			◆				◆	PSSu BP-C 1/8 S <sup>4)</sup>	312610																	◆	◆	
INC			◆			◆	◆	PSSu BP 1/8 S-J	312602																			◆
SSI	◆	◆	◆	◆	◆	◆	◆	PSSu BP-C 1/8 S-J	312612		◆			◆		◆			◆	◆								
INC	◆	◆	◆	◆	◆	◆	◆	PSSu BP 1/12 S	312618																			◆
INC	◆	◆	◆	◆	◆	◆	◆	PSSu BP-C 1/12 S	312620																			◆
INC	◆	◆	◆	◆	◆	◆	◆	PSSu BP-C1 1/12 S	312622																			◆
Sin/Cos, TTL, HTL, initiators 24 V	◆	◆	◆	◆	◆	◆	◆	PSSu BP 2/16 S	312628																			◆
Sin/Cos, TTL, HTL, initiators 24 V	◆	◆	◆	◆	◆	◆	◆	PSSu BP-C 2/16 S	312630																			◆
								PSSu BP 1/8 C <sup>3)</sup>	312601																			◆
								PSSu BP-C 1/8 C <sup>4)</sup>	312611																			◆
								PSSu BP 1/8 C-J	312603																			◆
								PSSu BP-C 1/8 C-J	312613																			◆
								PSSu BP 1/12 C	312619																			◆
								PSSu BP-C 1/12 C	312621																			◆
								PSSu BP-C1 1/12 C	312623																			◆
								PSSu BP 2/16 C	312629																			◆
								PSSu BP-C 2/16 C	312631																			◆

PLC controllers and I/O systems

-		◆				◆				◆	◆			◆	◆					◆	◆								
-		◆				◆																						◆	
-		◆				◆																						◆	
-		◆				◆				◆	◆			◆	◆					◆	◆							◆	

<sup>1)</sup>  The modules are also available as T-type for increased environmental requirements. The order numbers of the T-type modules are 314 ... instead of 312 ...

<sup>2)</sup>  The modules are also available as R-type for railway applications. The order numbers of the R-type modules are 315 ... instead of 312 ...

<sup>3)</sup> Without C-rail

<sup>4)</sup> With C-rail

<sup>5)</sup> Shield terminal available (312963)

<sup>6)</sup> Shield terminal available (312964)

## ▶ Accessories – PSSuniversal

### Accessories – PSSuniversal



PSSu XB F-T



PSSu XR F-T



SD Memory Card  
512MB

Type	Function
PSSu XB F-T	Base station used to extend the PSSu module bus by 0.5 m or 1 m, inside the control cabinet
PSSu XR F-T	Remote station used to extend the PSSu module bus by 0.5 m or 1 m, inside the control cabinet
PSSu A ET	End bracket for top-hat rail
PSSu A ETM	End bracket for top-hat rail, metal version, for high mechanical stresses
PSSu A EC	Terminating plate with integrated terminating resistor
PSSu A ET PE	Earthing terminal for top-hat rail, PE connection, GN/YE
PSSu A USB-CAB03	PSSu USB cable, length 3 m
PSSu A USB-CAB05	PSSu USB cable, length 5 m
SD Memory Card 512 MB	512 MB SD memory card for PSSu head modules
PSSu A Con 1/4 S	Connector set for power supply, 1-row, 4-pin, screw connection
PSSu A Con 2/8 C	Connector set for power supply, 2-row, 8-pin, spring-loaded connection
PSSu A Con 1/10 C	Connector set for compact modules, 1-row, 10-pin, spring-loaded connection
PSSu A Con 3/30 C	Connector set for compact modules, 3-row, 30-pin, spring-loaded connection
PSSu A Con 4 S	Connector for compact modules, 4-pin, screw connection (for INC module)
PSSu A Con 4 C	Connector for compact modules, 4-pin, spring-loaded connection (for INC module)
PSSu A Con Set1 C	Connector set for compact modules, set consisting of 1-row, 5-pin and 10-pin, spring-loaded connection (for K-F-EI module)

Certification	Order number	Suitable for
BG, CE, EAC (Eurasian), KOSHA, TÜV, cULus Listed	314 092 <sup>1)</sup>	▶ PSSu BP 2/16 S _____ 312 628 ▶ PSSu BP 2/16 C _____ 312 629 ▶ PSSu BP-C 2/16 S _____ 312 630 ▶ PSSu BP-C 2/16 C _____ 312 631
BG, CE, EAC (Eurasian), KOSHA, TÜV, cULus Listed	314 093 <sup>1)</sup>	Connection cable PSSu A RJ45-CAB 1.5M _____ 314 094 <sup>1)</sup>
-	312 900	-
-	312 901	-
cULus Listed	312 902	-
CE, cULus Listed	314 902 <sup>1)</sup>	-
-	312 949	-
-	312 992	-
-	312 993	-
-	313 100	-
BG, CE, TÜV, cULus Listed	313 110	Head modules in the automation system PSS 4000 (page 116)
BG, CE, TÜV, cULus Listed	313 111	Head modules in the automation system PSS 4000 (page 116)
BG, CE, TÜV, cULus Listed	313 115	-
BG, CE, TÜV, cULus Listed	313 116	-
-	313 117	-
CE, cULus Listed	313 118	-
CE, cULus Listed	313 114	-

<sup>1)</sup>  The modules are available as T-type for increased environmental requirements.

Keep up-to-date  
on PSSuniversal  
accessories:

 Webcode:  
web84867

Online information  
at [www.pilz.com](http://www.pilz.com)

## ► Technical details – Infrastructure components

### Unmanaged switches PSSnet SLL



PSSnet SLL 5T

Type	Technical features	Certification	Order number
PSSnet SLL 5T	5 electrical ports	CE, cULus Listed	380600
PSSnet SLL 4T 1FMMSC	<ul style="list-style-type: none"> <li>▶ 4 electrical ports</li> <li>▶ 1 fiber-optic port</li> <li>▶ Multimode connection</li> </ul>	CE, cULus Listed	380604

#### Common features

- ▶ Plug and play (no configuration necessary)
- ▶ Diagnostic LEDs

### Managed switches PSSnet SHL



PSSnet SHL 6T 2FSMSC MRP

Type	Technical features	Certification	Order number
PSSnet SHL 6T 2FMMSC MRP	<ul style="list-style-type: none"> <li>▶ 6 electrical ports</li> <li>▶ 2 fiber-optic ports</li> <li>▶ Multimode connection</li> </ul>	CE, cULus Listed	380602
PSSnet SHL 6T 2FSMSC MRP	<ul style="list-style-type: none"> <li>▶ 6 electrical ports</li> <li>▶ 2 fiber-optic ports</li> <li>▶ Single-mode connection</li> </ul>	CE, cULus Listed	380650

#### Common features

- ▶ Extensive management functions for configuration and diagnostics
- ▶ Web-based management for access via web browser
- ▶ Ring redundancy MRP
- ▶ Redundant voltage supply

### Firewall SecurityBridge



PCOM sec br1

Type	Technical features	Certification	Order number
PCOM sec br1	For safe authentication and communication with the configurable safe small controllers PNOZmulti	CE and approval in accordance with IEC 62443-4-1	311501
PCOM sec br2	For safe authentication and communication with the controllers of the automation system PSSu H PLC1 and PSSu H m as well as the configurable safe small controllers PNOZmulti	CE and approval in accordance with IEC 62443-4-1	311502

Keep up-to-date on Firewall SecurityBridge

Webcode: web188268

Online information at [www.pilz.com](http://www.pilz.com)



IloT Gateway Revolution Pi



RevPi Connect – RevPi Core Module

Type	Technical features	Certification	Order number
RevPi Connect – RevPi Core Module	-	CE, RoHS	Z9000017
RevPi Connect+ 32 GB	-	CE, RoHS	Z9000032
RevPi Connect+ 16 GB	-	CE, RoHS	Z9000038

Keep up-to-date on IloT gateway Revolution Pi

Webcode: web194958

Online information at [www.pilz.com](http://www.pilz.com)

SafetyNET p connector, cable and stripping tool



SafetyNET p Connector RJ45s



SafetyNET p Cable

Type	Technical features	Certification	Order number
SafetyNET p Connector RJ45s	<ul style="list-style-type: none"> <li>▶ Standard connector for IP20 installation</li> <li>▶ Quick connection</li> <li>▶ RJ45 mating face</li> <li>▶ Housing form compatible with PSSuniversal stabilizing collar</li> <li>▶ Ambient temperature: -40 °C ... +70 °C</li> </ul>	-	380 400
SafetyNET p Cable	<ul style="list-style-type: none"> <li>▶ Cable (by the meter)</li> <li>▶ Cable cross section AWG 22</li> <li>▶ CAT 5e, 4-wire</li> </ul>	-	380 000
SN CAB RJ45s RJ45s, 0,5 m	0.5 m cable with 2 x RJ45 connector	-	380 001
SN CAB RJ45s RJ45s, 1 m	1 m cable with 2 x RJ45 connector	-	380 003
SN CAB RJ45s RJ45s, 2 m	2 m cable with 2 x RJ45 connector	-	380 005
SN CAB RJ45s RJ45s, 5 m	5 m cable with 2 x RJ45 connector	-	380 007
SN CAB RJ45s RJ45s, 10 m	10 m cable with 2 x RJ45 connector	-	380 009
Stripping-Tool	Installation tool for SafetyNET p cable and connector	-	380 070

Keep up-to-date on:  
▶ Infrastructure components SafetyNET p

Webcode: web150453

Gateways



PSSnet GW1 MOD-EtherCAT

Type	Technical features	Certification	Order number
PSSnet GW1 MOD-CAN	Protocol converter from Modbus/TCP Slave to CANopen Slave	CE, cULus Listed	311 602
PSSnet GW1 MOD-EtherCAT	Protocol converter from Modbus/TCP slave to EtherCAT slave	CE, cULus Listed	311 601

▶ Gateways

Webcode: web150452

Online information at [www.pilz.com](http://www.pilz.com)

## ▶ Selection guide – Software

### Configuration tools for decentralized I/O system PSSuniversal



Type	Features
<b>PSSuniversal Startup Software incl. PSSuniversal Assistant</b> Configuration of and independent periphery test on decentralized I/O system PSSuniversal	<ul style="list-style-type: none"> <li>▶ Function test performed on a PSSuniversal system via the USB interface, without controller connected</li> <li>▶ FS and ST outputs are switched on/off</li> <li>▶ Input status display (supports e.g. the cabinet manufacturer during the wiring test)</li> <li>▶ Online help</li> </ul>

<sup>1)</sup> Startup Software PSSuniversal Assistant is license-free



### Software in automation system PSS 4000



Type	Features
<b>PAS4000</b> Software platform in the automation system PSS 4000	<ul style="list-style-type: none"> <li>▶ PAS STL, PAS IL, PAS LD editors in accordance with EN/IEC 61131-3</li> <li>▶ Graphics program editor PASmulti</li> <li>▶ Online help</li> <li>▶ Special license model</li> </ul>



### Visualization software PASvisu



Type	Features
<b>PASvisu</b> Web-based visualization software	<ul style="list-style-type: none"> <li>▶ Consists of the configuration tool PASvisu Builder and PASvisu Runtime</li> <li>▶ Wide range of predefined GUI elements (tiles)</li> <li>▶ Sophisticated visualization thanks to a wide variety of different style sheets</li> <li>▶ Optimum link between the control project (PAS4000) and visualization (PASvisu)</li> <li>▶ Convenient overview, locally and via remote access</li> </ul>

**Order number**

Software can be downloaded from the Internet: [www.pilz.com/pssuniversal\\_tools](http://www.pilz.com/pssuniversal_tools)

- ▶ Single user license (basic)<sup>1)</sup> \_\_\_\_\_ 312 890B
- ▶ Additional license (user)<sup>1)</sup> for an additional workstation \_\_\_\_\_ 312 890K

**Order number**

Software can be downloaded from the Internet: [www.pilz.com/pas4000](http://www.pilz.com/pas4000)

PASunits: Once enabled for production operation, the project is licensed in PAS4000, PASunits for the used functions are calculated and then credited to the project from the software's points account.

- ▶ PASunits 500 \_\_\_\_\_ 317 910
- ▶ PASunits 1 000 \_\_\_\_\_ 317 920
- ▶ PASunits 5 000 \_\_\_\_\_ 317 930
- ▶ PASunits 10 000 \_\_\_\_\_ 317 940
- ▶ PASkey: USB crypto memory for secure storage and transfer of PASunits \_\_\_\_\_ 317 999

**Order number**

Software can be downloaded from the Internet at [www.pilz.com/pasvisu](http://www.pilz.com/pasvisu)

Keep up-to-date on:  
▶ PSSuniversal tools

 Webcode:  
web150426

▶ PSS 4000 tools

 Webcode:  
web150424

Online information  
at [www.pilz.com](http://www.pilz.com)

## ▶ Selection guide – Software blocks PAS4000®



### General failsafe control blocks



FS\_EmergencyStop



FS\_TwoHandControl



Type	Function
<b>FS_EmergencyStop</b>	Configures and monitors operation of E-STOP pushbuttons with one or two N/C contacts.
<b>FS_LightCurtain</b>	Monitors the function of light curtains with 2 N/C contacts.
<b>FS_SafetyGate</b>	Monitors the function of safety gate switches with up to 3 contacts.
<b>FS_Operating ModeSelectorSwitch</b>	Monitors up to 8 positions on an operating mode selector switch. Inputs which are not required can be left unassigned. After a switchover time has expired, no more than one contact is allowed to be in the closed state at any one time.
<b>FS_SafetyValve</b>	Monitors the operation of safety valves of the single, double and directional type.
<b>FS_TwoHandControl</b>	Monitors whether the two buttons on the two-hand control are operated simultaneously (within 0.5 s). In accordance with EN 574, two-hand pushbuttons of type IIIA (2 N/O contacts) or type IIIC (combination of 2 N/O and 2 N/C contacts) can be used.
<b>FS_Muting</b>	Used to temporarily suspend safety functions (ESPE/AOPD) without interrupting the process (muting), in accordance with EN 61496-1.
<b>FS_CounterDual</b>	Used in conjunction with the blocks FS_AbsoluteEncoder and/or FS_IncrementalEncoder to calculate the following safe values: Position, speed and standstill.

The PAS4000 software blocks can be found directly within the tool in the software library.  
Tool download: [www.pilz.com/PAS4000](http://www.pilz.com/PAS4000)

Hardware-related blocks



Type	Function
<b>FS_Absolute Encoder</b>	Calculates a counter status (in increments) from the measured value from the absolute encoder and monitors the module status.
<b>FS_Incremental Encoder</b>	Initializes the counter, calculates the current counter status (in increments) and transmits status information.
<b>FS_AnalogInput Dual</b>	Monitors redundant, analog input values for upward violation of a value range, downward violation of a value range and upward violation of a difference between the analog input value 0 and analog input value 1 over a defined period of time (plausibility check).
<b>FS_Scaling</b>	Scales an analog input value and sends it to an O-variable.
<b>FS_EI_Basic</b>	Block for compact module PSSu K F EI.
<b>FS_EI_SSM0</b>	Block for compact module PSSu K F EI for safe speed monitoring (SSM).
<b>FS_EI_SOSM</b>	Block for compact module PSSu K F EI for safe operating stop monitoring (SOS-M).
<b>FS_EI_SDIM</b>	Block for compact module PSSu K F EI for safe direction monitoring (SDI-M).
<b>FS_EI_SSM1_SSRM</b>	Block for compact module PSSu K F EI for safe speed range monitoring (SSR-M).

Press control blocks



Type	Function
<b>FS_PressOperating Modes</b>	Controls and monitors the setup, single stroke and automatic operating modes of a mechanical press.
<b>FS_CamEvaluation</b>	Monitors the mechanical rotary cam arrangement of a press for: plausibility of the signals from the overrun cam and run-up cam, failure of the dynamic cam and overrun cam, upward violation of the overrun at top dead center.
<b>FS_CycleMode LightCurtain</b>	Enables the cycle mode (control) for triggering the press stroke when using a light curtain in the standard and Sweden operating modes.
<b>FS_CamController</b>	Provides the position signals for a press control. It uses the angle values, e.g. from the block FS_PositionToAngle, to determine the signal for achieving the top dead center and so enables shutdown of the press. It is used in the safe, electronic rotary cam arrangement.

Keep up-to-date on PAS4000:

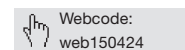

Online information at [www.pilz.com](http://www.pilz.com)

The PAS4000 software blocks can be found directly within the tool in the software library.  
 Tool download: [www.pilz.com/PAS4000](http://www.pilz.com/PAS4000)

## ▶ Remote I/O system PSSuniversal 2



The PSSuniversal 2 remote I/O system is the new generation of universal systems from Pilz. PSSuniversal 2 offers flexibility, openness and granularity in a single system for safety and automation. You can choose between a communication module with PROFINET/PROFIsafe or EtherNet/IP, CIP Safety interface and analog, digital, safety-related, non-safety-related I/O modules. The three-part system structure offers user-friendly installation and servicing.



EtherNet/IP™

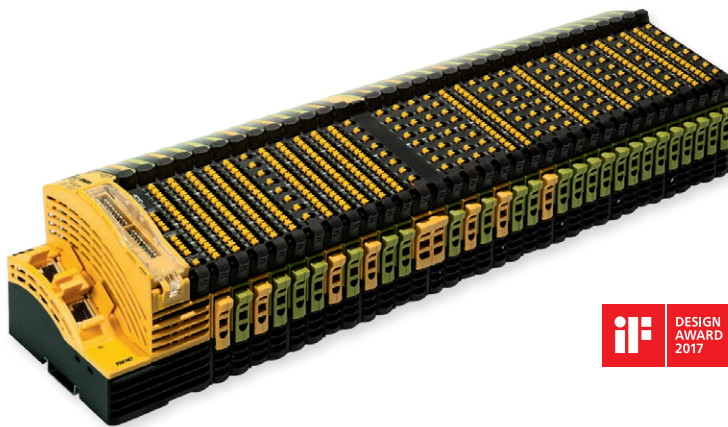

### Your benefits at a glance

- ▶ Easy, flexible and granular:
  - Optimized handling during commissioning and service
  - Three-part system structure reduces servicing work
- ▶ Compact:
  - Minimum dimensions due to maximum packing density, with up to 16 channels on 12.5 mm
- ▶ Functional safety as a basic function:
  - Design of safety and standard functions that can be combined at will
- ▶ Precise diagnostics:
  - Concordant display of the faulty module slot and the terminal affected
  - Rapid fault localization and troubleshooting
- ▶ Openness:
  - Ability to adapt to PROFINET/PROFIsafe, EtherNet/IP, CIP Safety and more by exchanging the head module
  - Safe I/O modules universally usable in an identical manner for a wide variety of safety protocols



**Simple configuration**

The remote I/O system PSSUniversal 2 is configured using the new software PASconfig. This software allows you to put the system into operation quickly and simply. PASconfig can be called up directly from the Tool Calling Interface of the TIA portal.

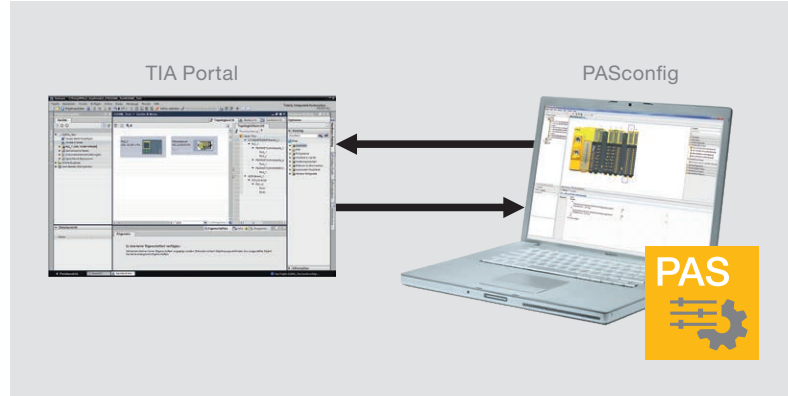

Software tool PASconfig for advanced configuration from the TIA Portal.

**Improved mechanical design**

The new three-part system design significantly reduces the work involved in service and maintenance. Diagnostics can be performed with great precision in the remote I/O system. Modules can be hot-swapped. As a result the head module can be swapped without having to reconfigure. It is no longer necessary to completely dismantle the system to swap the backplane. PSSUniversal 2 offers a high level of operating safety thanks to individual coding.

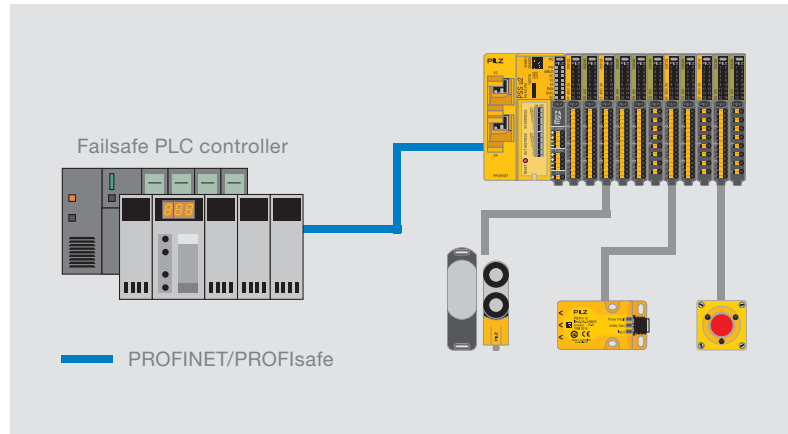

Standard and safety-related connection via PROFINET/PROFIsafe.

Keep up-to-date on the remote I/O system PSSUniversal 2:

Webcode: web150509

Online information at [www.pilz.com](http://www.pilz.com)

PLC controllers and I/O systems



**Connection to IO-Link devices possible**

A module with IO-Link master is available for the remote I/O system PSSUniversal 2 which can be integrated into PROFINET/PROFIsafe and EtherNet/IP, CIP Safety networks using appropriate head modules. The module provides four IO-Link ports to which you can connect IO-Link devices (sensors or actuators). This means that the remote I/O system PSSUniversal 2 can now also communicate with sensors and actuators via the globally standardized IO-Link interface (IEC 61131-9). The configuration of the IO-Link devices can be stored in the IO-Link master and simply transferred when exchanging during service. This saves time and reduces errors and plant downtimes!



## ► Technical details – PSSuniversal 2

### Remote I/O system PSSuniversal 2 – head module



PSS u2 P0 F/S PN

Type	Communication interfaces	Application area	
		Failsafe functions	Automation functions
PSS u2 P0 F/S PN	2 x PROFINET/PROFIsafe	◆	◆
PSS u2 P0 F/S EIP	2 x EtherNet/IP, CIP Safety	◆	◆

### Backplanes/module racks



PSS u2 B 4

Type	Function	Application area	
		Failsafe functions	Automation functions
PSS u2 B 4	Module rack with 4 slots	◆	◆
PSS u2 B 1	Module rack with 1 slot	◆	◆

### Supply modules/junction modules



PSS u2 ES 16PT 0V

Type	Function
PSS u2 ES 16PT 0V	Standard patch terminal module, 0 V supply, 16x
PSS u2 ES 16PT FE	Standard patch terminal module, functional earth, shield connection, 16x
PSS u2 ES 16PTD 24V	Standard patch terminal module, 24 V supply, with diagnostic capabilities, 16x
PSS u2 ES 8PTD 24V 0V	Standard patch terminal module, 24 V supply, 0 V supply, with diagnostic capabilities, 16x
PSS u2 ES PSP	Voltage supply module, 24 V/8 A periphery supply



Features	Certification	Order number	Suitable terminal block
<ul style="list-style-type: none"> <li>▶ Head module PROFINET Client/PROFIsafe Device</li> <li>▶ Integrated Ethernet switch (two Ethernet ports)</li> <li>▶ Can be configured using the PASconfig tool</li> <li>▶ PSS u2 backplane bus for connecting up to 64 I/O modules</li> <li>▶ Dimensions (H x W x D) in mm: 110.1 x 64.1 x 94.7</li> </ul>	CE, TÜV, cULus Listed	328061	328831
<ul style="list-style-type: none"> <li>▶ Head module EtherNet/IP Client/CIP Safety Device</li> <li>▶ Integrated Ethernet switch (two Ethernet ports)</li> <li>▶ Can be configured using the PASconfig tool</li> <li>▶ PSS u2 backplane bus for connecting up to 64 I/O modules</li> <li>▶ Dimensions (H x W x D) in mm: 110.1 x 64.1 x 94.7</li> </ul>	CE, TÜV, cULus Listed	328071	328831

Features	Certification	Order number
<ul style="list-style-type: none"> <li>▶ Backplane and module supply</li> <li>▶ Dimensions (H x W x D) in mm: 107.0 x 53.9 x 32.9</li> </ul>	CE, cULus Listed, UL	328810
<ul style="list-style-type: none"> <li>▶ Backplane and module supply</li> <li>▶ Dimensions (H x W x D) in mm: 107.0 x 16.4 x 32.9</li> </ul>	CE, cULus Listed, UL	328811

Features	Certification	Order number	Suitable terminal block
16 terminal connections, 0 V potential	CE, cULus Listed	328090	328850
16 terminal connections, functional earth	CE, cULus Listed	328091	328850
16 terminal connections, 24 VDC/0.5 A	CE, cULus Listed	328085	328850
<ul style="list-style-type: none"> <li>▶ 8 terminal connections, 0 V</li> <li>▶ 8 terminal connections, 24 VDC/0.5 A</li> </ul>	CE, cULus Listed	328092	328850
Infeed of periphery voltage 24 VDC, max. 8 A	CE, cULus Listed	328080	328840

PLC controllers and I/O systems

Keep up-to-date on the remote I/O system PSSuniversal 2:

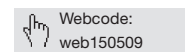

Online information at [www.pilz.com](http://www.pilz.com)

## ► Technical details – PSSuniversal 2

### Digital inputs and outputs



PSS u2  
EF 2DO R 8A



PSS u2 ES 4DI

Type	Function	Application area	
		Failsafe functions	Automation functions
PSS u2 EF 8DI	8 digital inputs	◆	
PSS u2 EF 8DO 0.5A	8 digital outputs	◆	
PSS u2 EF 4DO 2A	4 digital outputs	◆	
PSS u2 EF 2DO TP 2A	2 digital outputs	◆	
PSS u2 EF 2DO R 8A	2 relay outputs	◆	
PSS u2 ES 4DID	4 digital inputs		◆
PSS u2 ES 8DID	8 digital inputs		◆
PSS u2 ES 4DI	4 digital inputs		◆
PSS u2 ES 8DI	8 digital inputs		◆
PSS u2 ES 4DOD 0.5A	4 digital outputs		◆
PSS u2 ES 8DOD 0.5A	8 digital outputs		◆
PSS u2 ES 16DOD 0.5A	16 digital outputs		◆
PSS u2 ES 4DOD 2A	4 digital outputs		◆
PSS u2 ES 16 DI	16 digital inputs		◆
PSS u2 ES 4DO SR 0.5A	4 relay outputs		◆
PSS u2 ES 4AI U	4 analog inputs		◆
PSS u2 ES 4DO R 8A	4 relay outputs		◆
PSS u2 ES 4AI I	4 analog inputs		◆
PSS u2 ES 4AO U/I	4 analog outputs		◆
PSS u2 ES 4IOL	4 IO-Link master interfaces		◆
PSS u2 ES 8DI NPN	8 NPN inputs		◆
PSS u2 ES 6DI 120V AC	6 digital inputs		◆

Features	Certification	Order number	Suitable terminal block
8 digital inputs (24 V), 8/4 test pulse outputs	CE, TÜV, cULus Listed	328 101	328 850
8 positive switching semiconductor outputs, max. 0.5 A	CE, TÜV, cULus Listed	328 131	328 850
4 positive switching semiconductor outputs, max. 2 A	CE, TÜV, cULus Listed	328 133	328 840
2 semiconductor outputs, 2-pole, max. 2 A	CE, TÜV, cULus Listed	328 140	328 840
2 N/O contacts, 250 VAC/10 A, 24 V/10 A	CE, TÜV, cULus Listed	328 150	328 840
4 digital inputs (24 V), extended diagnostics	CE, cULus Listed	328 310	328 840
8 digital inputs (24 V), extended diagnostics	CE, cULus Listed	328 311	328 850
4 digital inputs (24 V)	CE, cULus Listed	328 300	328 840
8 digital inputs (24 V)	CE, cULus Listed	328 301	328 840
4 positive switching semiconductor outputs, max. 0.5 A, extended diagnostics	CE, cULus Listed	328 400	328 840
8 positive switching semiconductor outputs, max. 0.5 A, extended diagnostics	CE, cULus Listed	328 401	328 850
16 positive switching semiconductor outputs, max. 0.5 A, extended diagnostics	CE, cULus Listed	328 402	328 850
4 positive switching semiconductor outputs, max. 2 A, extended diagnostics	CE, cULus Listed	328 410	328 840
16 digital inputs (24 V)	CE, cULus Listed	328 303	328 850
4 N/O contacts, C/O contacts	CE, cULus Listed	328 421	328 850
4 analog inputs (voltage measurement)	CE, cULus Listed	328 500	328 850
4 N/O contacts	CE, cULus Listed	328 420	328 840
4 analog inputs (current measurement)	CE, <sup>1)</sup>	328 520	328 850
4 analog outputs (0 ... 10 V, -12 ... 12 V; 0 ... 20 mA, -24 ... 24 mA)	CE, <sup>1)</sup>	328 551	328 850
4 IO-Link ports v1.1	CE, IO-Link, <sup>1)</sup>	328 770	328 850
8 digital NPN inputs (type 3)	CE, <sup>1)</sup>	328 206	328 840
6 digital inputs (120 V)	CE, cULus Listed	328 308	328 840

<sup>1)</sup> Approval for the North American market is currently in preparation

Keep up-to-date  
on the remote  
I/O system  
PSSuniversal 2:

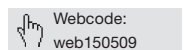

Webcode:  
web150509

Online information  
at [www.pilz.com](http://www.pilz.com)

## ► Technical details – PSSuniversal 2

### Accessories



PSS u2 A LA E1

Type	Function
PSS u2 A LC E1 (10 pcs.)	Label holder 23.5 x 10.5 mm, 10 pcs.
PSS u2 A LC E2 (10 pcs.)	Label holder 103 x 10.5 mm, 10 pcs.
PSS u2 A LC T3 (10 pcs.)	Label holder for terminal block, 61 x 11.5 mm, 10 pcs.
PSS u2 A CE E (10 pcs.)	Coding element, 10 pcs.
PSS u2 A CE T (10 pcs.)	Coding strip, 10 pcs.
PSS u2 A SH 4 (10 pcs.)	Shield connection element for backplane/module rack with 4 slots (pack of 10)
PSS u2 A LA E1 (10 pcs.)	Label strips 23.5 x 10.5 mm (10 DIN A4 sheets)
PSS u2 A LA E2 (10 pcs.)	Label strips 103 x 10.5 mm (10 DIN A4 sheets)
PSS u2 T 8 (1 pc.)	8-pin terminal block, scope: 1 piece
PSS u2 T 8 (10 pcs.)	8-pin terminal block, scope: 10 pieces
PSS u2 T 8 (5 x 10 pcs.)	8-pin terminal block, scope: 50 pieces
PSS u2 T 9 SD (1 pc.)	9-pin terminal block for head module, scope: 1 piece
PSS u2 T 16 (1 pc.)	16-pin terminal block, scope: 1 piece
PSS u2 T 16 (10 pcs.)	16-pin terminal block, scope: 10 pieces
PSS u2 T 16 (5 x 10 pcs.)	16-pin terminal block, scope: 50 pieces
µSD Card 512 MB industrial	microSD memory card 512 MB

	Certification	Order number
	-	328910
	-	328911
	-	328912
	-	328860
	-	328861
	-	328820
	-	328913
	-	328914
	cURus	328840
	cURus	328841
	cURus	328842
	cURus	328831
	cURus	328850
	cURus	328851
	cURus	328852
	CE	328835

Keep up-to-date  
on the remote  
I/O system  
PSSuniversal 2:

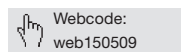

Online information  
at [www.pilz.com](http://www.pilz.com)

## ► Drive technology PMC

As a market and technology leader, Pilz offers overall solutions for safety and automation. Part of these solutions is Pilz drive technology. Pilz Motion Control – PMC provides overall solutions for automating your machine. From control systems to servo amplifiers, right up to servo motors: at Pilz you can buy everything from one source. Embedded within the respective system environment, including all safety aspects plus the relevant accessories. The focus is always on your application. Whether it's individual components or the complete solution: with Pilz drive technology, there are no limits.

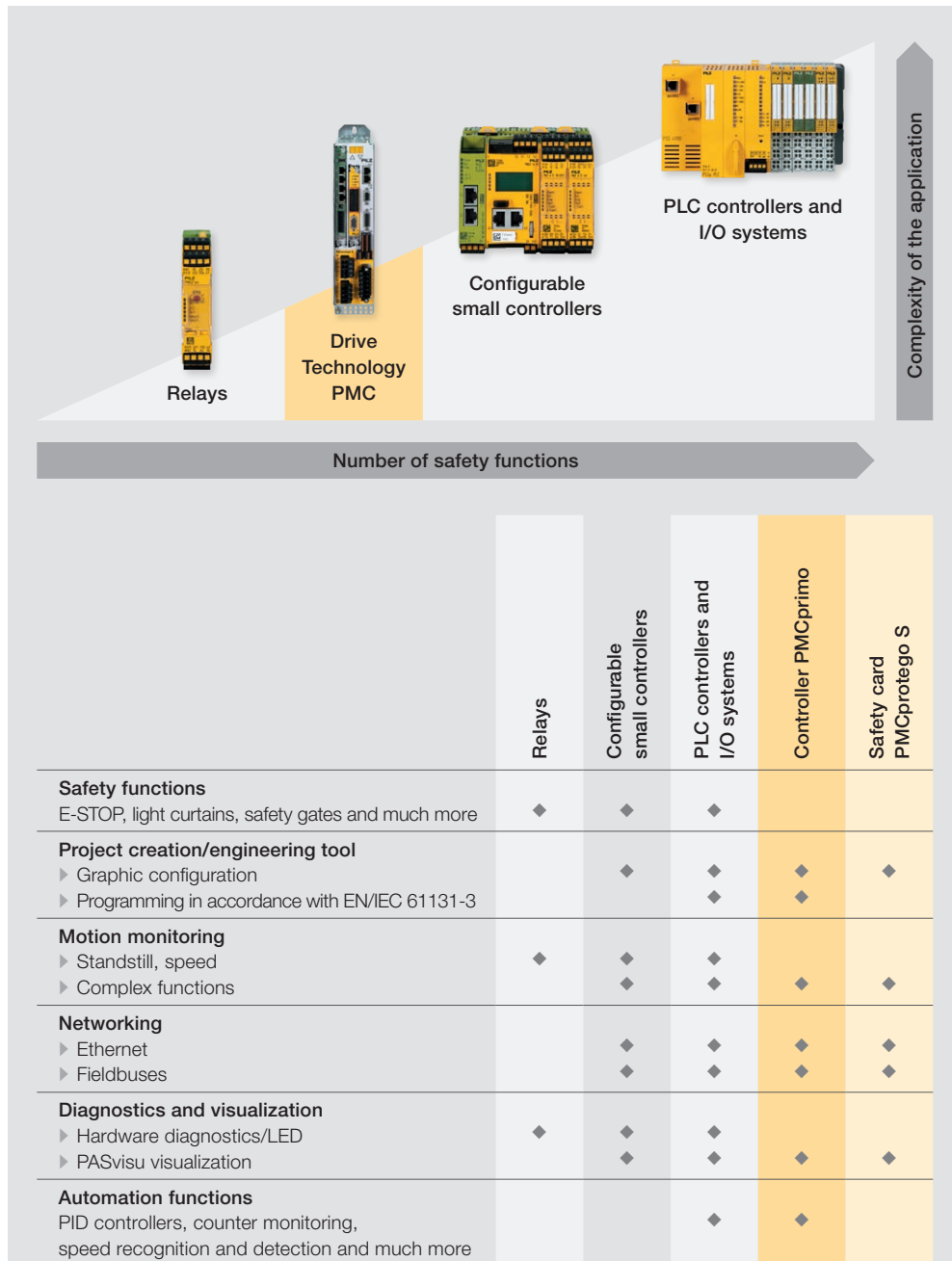



#### **Product area**

#### **Drive technology PMC**

144

- ▶ Applications and industries

146

#### **Product group**

#### **Motion control systems**

- ▶ Motion control system PMCprimo
- ▶ Control system PMCprimo DriveP
- ▶ Operator terminals PMI 6 primo

148

150

152

#### **Product group Servo amplifiers**

- ▶ Servo amplifier PMCprotego D
- ▶ Safety card PMCprotego S

158

162

#### **Product group Motors**

- ▶ Servo motors PMctendo SZ with HIPERFACE DSL®

166

## ▶ Pilz drive technology – safe, energy efficient, open,



Pilz Motion Control provides overall and energy-efficient solutions for your machine automation. The portfolio comprises both individual components and complete solutions: from motion control systems and servo amplifiers to servo motors, including all safety aspects. Pilz drive technology is embedded into the relevant system environment – whether a new structure or a retrofit – and is open for a variety of interfaces and functionalities.

### Expert advice on all issues relating to your drive

From planning to implementation, Pilz is right there beside you as your competent partner. The range of services extends from risk assessment to drive configuration, hardware and software design through to commissioning. Regular safety checks and a comprehensive range of training measures complete our range.

### Your benefits at a glance

- ▶ Safe: up to PL e of EN ISO 13849-1 for each piece of feedback
- ▶ Energy efficient: high energy savings thanks to efficient servo technology
- ▶ Open: highly flexible because various fieldbus systems, feedback systems and functionalities can be used
- ▶ Productive: short cycle times enable high performance
- ▶ Simple parameter setting and diagnostics thanks to intuitive commissioning tools

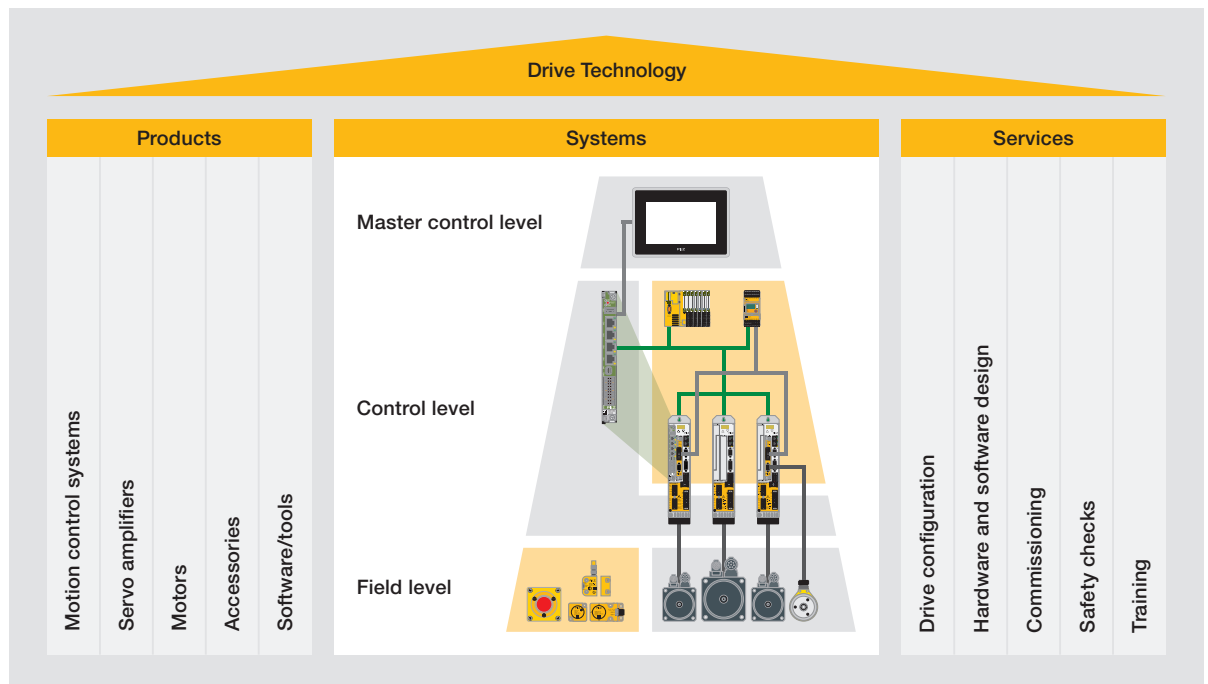

Pilz drive technology: Products, services, systems – the one stop shop.



# productive

## Minimize downtimes

Thanks to the PVIS diagnostic concept, system messages from the PMC control systems and servo amplifiers can be displayed in plain text. Remedy messages are displayed for each event. PVIS significantly reduces downtimes in the case of a fault. Thanks to pre-defined messages, even project configuration is simple.



## Your benefits at a glance







- ▶ For simple to high end applications
- ▶ Solution is always expandable thanks to the modular design
- ▶ Fast to commission and simple to service thanks to universal programming in accordance with EN/IEC 61131-3
- ▶ Complete automation solution or individual components – depending on your requirement
- ▶ Customized solutions incorporating all safety aspects
- ▶ Individual advice and customer care



## Open and flexible connection

Safe drive technology – safe motion – is open for connection to all standard PLC and motion control systems. Benefit from the high flexibility of our solutions, e.g. if only part of the machine is renovated during a retrofit.

### Overview of control systems and servo amplifiers

	Control systems			Safe drive-based	Servo amplifiers	
	Controller-based					
	 PMI 6 primo	 PMCprimo MC	 PMCprimo C2	 PMCprimo DriveP	 PMCprótego D	 PMCprótego DS
Soft PLC programming in accordance with EN/IEC 61131-3	◆	◆	◆	◆		
Motion control	◆	◆	◆	◆		
Servo amplifiers				◆	◆	◆
Safe Torque Off				◆		◆
Additional safety functions				◆		◆

Keep up-to-date on drive technology PMC:



Webcode: web150506

Online information at [www.pilz.com](http://www.pilz.com)

## ► For a wide range of applications

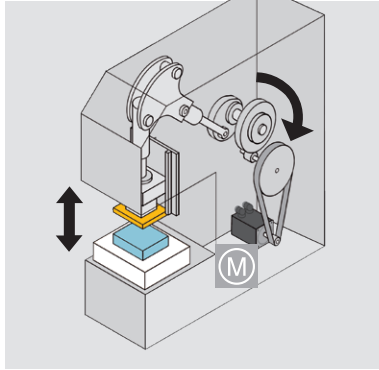

### Servo press

Presses with servo drive increase the output rate compared with conventional presses and provide maximum flexibility. The safe motion solution is suitable for implementation of the necessary safety level PL e of EN ISO 13849-1 and SIL CL 3 of EN/IEC 62061. Functions such as “Safely Limited Speed” in setup mode, “Safe Direction” during the light grids' muting phase and “Safe Brake Control” enable operators to work safely within the danger zone.

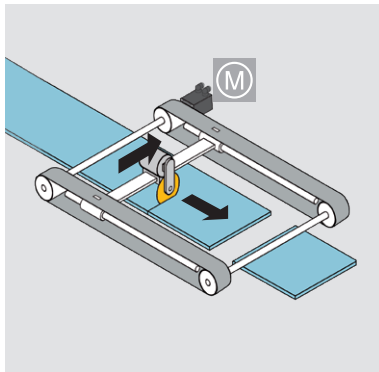

### Flying saw

When cutting endless material such as wood or sheet metal for example, the flying saw moves synchronously with the material to be cut, so that the machining process does not need to be stopped. Once machining is finished, the cycle is restarted. If you add a safety aspect to this classic motion control function, the flying saw can be set up without risk at “Safely Reduced Speed”, for example.

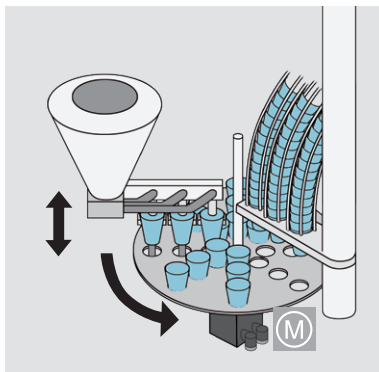

### Filling

When filling liquid or paste products, axis movements are precisely co-ordinated. Motion sequences for setting dosing plungers and lifters can be set individually. Filling is so accurate that no material is spilt. The packaging size and associated fill volume can be modified. Recipes can also be incorporated for different fillings or weights.



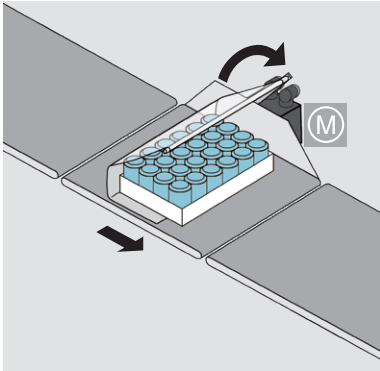

**Wraparound**

The wraparound application places high demands on precision and on the synchronicity of axis movements. The position of the product to be wrapped is identified first, then the film is unwound and the imprint is positioned precisely in the designated place. Plus the film is cut before the product is fully wrapped. An intelligent motion control system is a prerequisite for synchronizing the relevant axes.

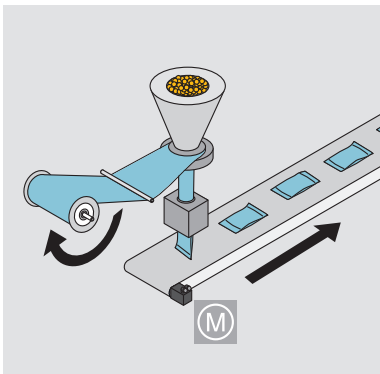

**Flow wrapping machine**

When flow wrap bags are filled, various motion sequences are synchronized, such as unwinding the flow wrap bags, packing the product and transporting it to the end packing station. The motion control system with its functions and reaction times has considerable influence on process quality. Fast inputs for print mark sensors enable a rapid reaction to print marks on the overwrap film and the necessary adjustment of the motion curves.

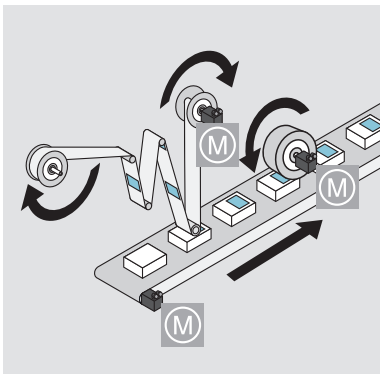

**Labelling**

The unwind shaft and conveyor must be synchronized in order to position labels precisely. A sensor detects the label and sends a signal to the motion control system, in order to compensate for the tolerances that occur by adapting the motion paths. Short cycle times and fast digital inputs on the motion control system guarantee optimum synchronization of the relevant axes and precision label placement.



## ► Motion control systems PMCprimo®

Control systems PMCprimo MC, PMCprimo DriveP (with control system PMCprimo C2) and PMI 6 primo are used for all types of control and motion tasks. They consist of PLC and motion technology. They perform the automation within a plant, including management of all the movements for several physically separate servo axes.

Universal programming under EN/IEC 61131-3 (CODESYS V3.5) in one project, covering standard PLC to motion control functionality, provides the basis for a wide range of functions:

- ▶ (Shock-free) positioning
- ▶ Virtual main shaft
- ▶ Electrical gearbox
- ▶ Cam mechanism
- ▶ Integral “flexible cam”
- ▶ Register control
- ▶ Web tension control
- ▶ PLC functionality
- ▶ Linear and circular interpolation
- ▶ Electronic camshaft
- ▶ Fast inputs to detect print marks

### Combining economy with safety

A compact and cost-effective solution is available with the drive-based control systems PMCprimo DriveP. From the second axis onwards, the servo amplifiers are simply connected to the drive bus. This reduces the space requirement in the control cabinet, plus you have an economical solution for your application. This solution also provides the “Safe Torque Off” (STO) function by connecting the servo amplifier PMCprotego D. The optional safety card PMCprotego S enables additional functions to be added such as SLS, SBC and SBT.

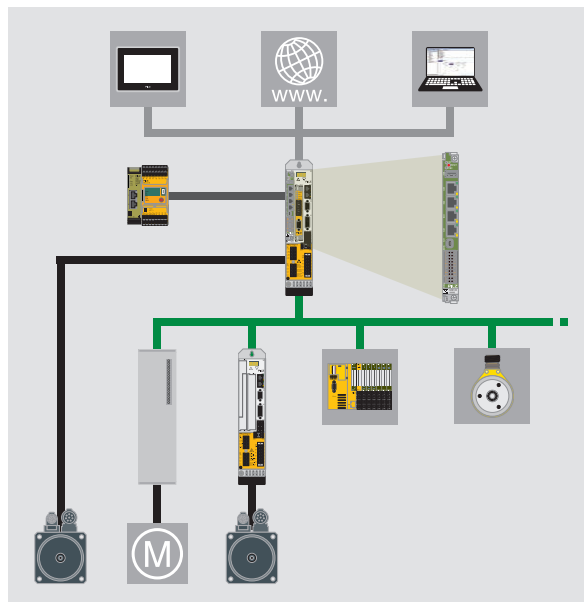

Safe drive-based control system  
PMCprimo DriveP with PMCprimo C2.

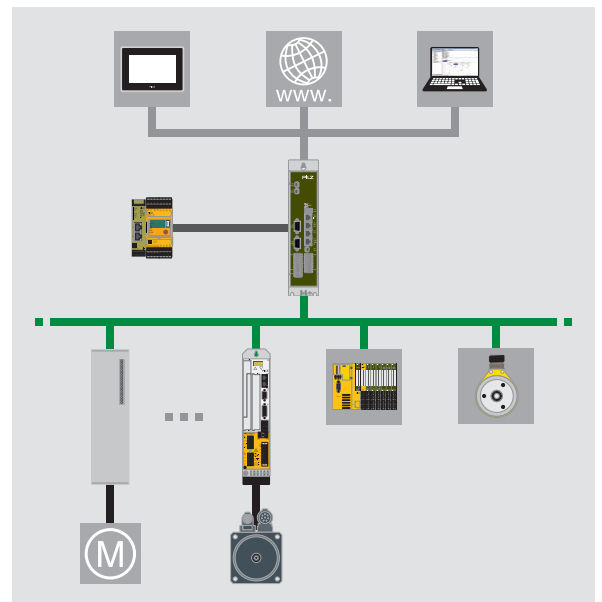

Open, controller-based control system  
PMCprimo MC.

### All-in-one motion control

The safe drive-based control system PMCprimo DriveP is suitable when the demand is for control tasks with a high performance level. Incorporate the motion control card PMCprimo C2 into the servo amplifier PMCprotego D and the result is an extremely compact, high-performance system for up to 16 axes. As an option, safety functions can also be expanded using the safety card PMCprotego S.

### Flexibility through openness

The controller-based hardware platform with its many interfaces provides the basis for an open system.

### Your benefits at a glance

- ▶ Solution is always expandable thanks to the modular design
- ▶ Two hardware platforms, providing the optimum hardware basis for each application
- ▶ Combination of PLC and power element (PMCprimo Drive) provides an economical solution
- ▶ Open for house standards and customer requirements thanks to a wide range of interfaces
- ▶ Fast to commission and simple to service thanks to universal programming in accordance with EN/IEC 61131-3
- ▶ Suitable for simple to complex applications

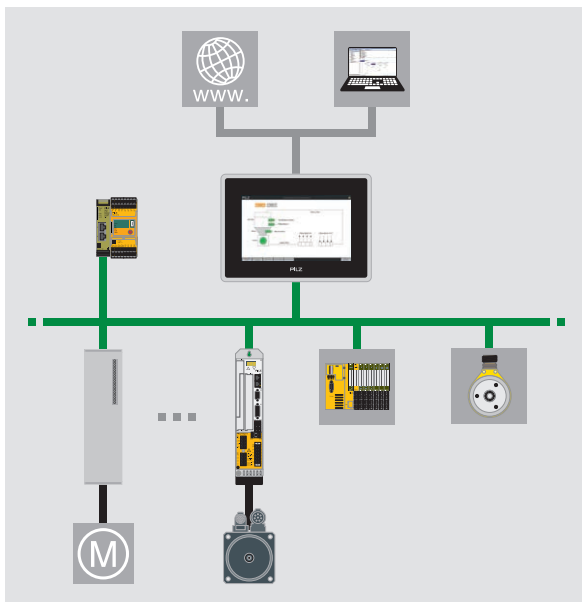
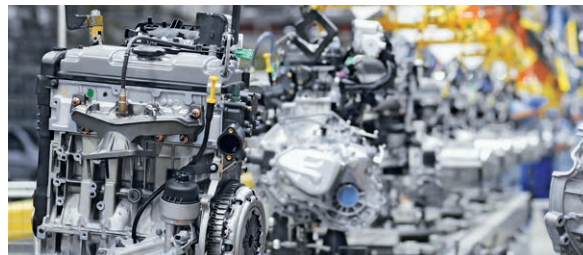

Visualization-based control system PMlprimo.

Keep up-to-date on control systems  
PMCprimo:

Webcode:  
web5531

Online information at [www.pilz.com](http://www.pilz.com)

## ▶ Control system PMCprimo DriveP: All-in-one motion

Plug the motion control card PMCprimo C2 into the servo amplifier PMCprotego D and the result is an extremely compact, high-performance motion control system.

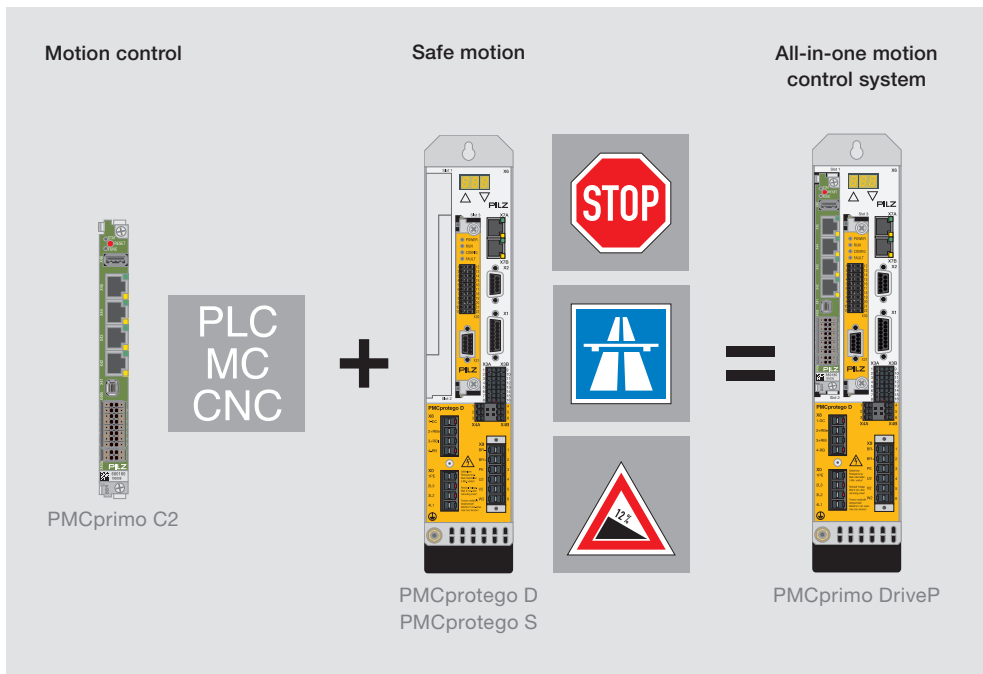

### Compact solution

Due to the compact dimensions, motion control, PLC and safety functions can be combined in one unit – making it the most compact solution on the market. Clear, user-friendly software tools simplify commissioning of the motion control system and can save time through clear project documentation.

Fieldbus communication lightens the load on the processor thanks to the FPGA chip, enabling the implementation of more complex plants with multiple axes. The integration of multiple communication stacks reduces the number of product types as well as storage costs. High performance communication between processor and FPGA also reduces the system reaction times.

The high processing power of the motion control system PMCprimo DriveP also enables low process tolerances. Thanks to the EtherCAT network, short cycle times with up to 16 axes can be achieved. This increases the process quality due to shorter bus cycle times. The parallel operation of up to two CANopen networks generates ample scope and flexibility for complex machinery.

### All-in-one with safe motion

The servo amplifier is used in safety-related applications up to PL e of EN ISO 13849-1 and SIL 3 of EN/IEC 62061. The safety card PMCprotego S can also be used as an option to expand the PMCprotego D with drive-integrated safety functions in accordance with EN 61800-5-2 – thus completing the all-in-one motion control system from Pilz.



# control

## Economical due to additional inputs and outputs

The inputs and outputs on the servo amplifier can be evaluated and controlled by the servo amplifier PMCprimo C2 as well as the eight digital input and outputs on the motion control system. The additional inputs and outputs guarantee an economical solution and flexibility for your application. The wide range of interfaces also offer openness to suit individual requirements. The use of fast inputs on the motion control card PMCprimo C2 in the servo amplifier also enables print mark detection. As a result, faster system reaction times are achieved, enabling more axes and therefore larger machines and systems to be controlled at the same time.

All the configuration data is stored on the SD memory card, so no additional components such as PC, software or cables are required when exchanging units or expanding the system. The memory card can simply be inserted into the new device.

## Your benefits at a glance

- ▶ Short cycle times and high performance
- ▶ Long availability through use of the latest Intel® processors
- ▶ Higher performance thanks to shorter scan times
- ▶ More space in the control cabinet thanks to the compact, drive-integrated solution
- ▶ Simple, fast commissioning
- ▶ High productivity thanks to short reaction times
- ▶ Fast digital inputs (5 µs) enable higher material speed
- ▶ Fast, user-friendly introduction and project documentation as a result of clear software tools



### Feedback



Resolver  
EnDat  
HIPERFACE DSL  
BiSS  
Incremental encoder  
Sensorless

### Bus interfaces PMCprotego D + DS



EtherCAT  
CANopen  
Optional:  
PROFINET  
PROFI BUS

### Bus interfaces PMCprimo DriveP



EtherCAT  
CANopen  
PROFI BUS

## ► Operator terminals PMI 6 primo – with PLC, motion



PMI 607 primo

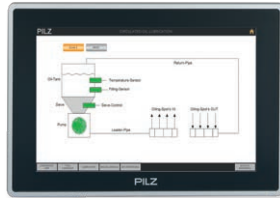

PMI 612 primo



PMI 638 primo

Operator terminals PMI 6 primo have PLC, motion and CNC functionality. They perform the automation within a plant, including motion management. Up to 16 axes can be linked flexibly to form a kind of electronic main shaft, and simple CNC tasks can be managed. The functions “flying saw”, “cross cutter” or “cam discs” and many more can be easily implemented with the operator terminal. Machine functions such as “flow wrapping” are also available.

The PMI 6 primo touchscreens are available in 7, 12 or 15 inches. The powerful processor and memory provide a powerful platform for your automation tasks.

The operator terminals are already equipped with a user-friendly visualization unit, yet are compatible with any standard HMI software. A PMI Assistant is available, making it even easier to install the software packages.



### Selection guide – Operator terminals PMI 6 primo

Type	Features
<b>PMI 607 primo</b>	<ul style="list-style-type: none"> <li>▶ Diagonal: 7"</li> <li>▶ Resolution: 800 x 480 pixels</li> <li>▶ Power consumption: 14.4 W</li> <li>▶ Capacitive glass touchscreen</li> <li>▶ Color depth: 16.2 million colors</li> <li>▶ Format: 16:9</li> </ul>
<b>PMI 612 primo</b>	<ul style="list-style-type: none"> <li>▶ Diagonal: 12"</li> <li>▶ Resolution: 1 280 x 800 pixels</li> <li>▶ Power consumption: 21.6 W</li> <li>▶ Capacitive glass touchscreen</li> <li>▶ Color depth: 16.2 million colors</li> <li>▶ Format: 16:9</li> </ul>
<b>PMI 638 primo</b>	<ul style="list-style-type: none"> <li>▶ Diagonal: 15"</li> <li>▶ Resolution: 1 024 x 768 pixels</li> <li>▶ Power consumption: 25.6 W</li> <li>▶ Resistive film touchscreen</li> <li>▶ Color depth: 65 000 colors</li> <li>▶ Format: 4:3</li> </ul>



# and CNC functionality

## Your benefits at a glance

- ▶ High degree of integration and fast commissioning with minimum space requirement
- ▶ Flexible to use, since PMI 6 primo comprises PLC, motion and CNC functionality
- ▶ Soft PLC in accordance with EN/IEC-61131-3 standard (CODESYS V3.5)
- ▶ Increased flexibility and wide range of applications thanks to EtherCAT Master, CAN, Modbus/TCP and PROFIBUS-DP-S
- ▶ Optimum combination options with PSSu I/Os from Pilz
- ▶ Integration of the configurable safe small controllers PNOZmulti via Ethernet
- ▶ Compact, powerful platform based on the latest processor
- ▶ Equipped with the Windows Embedded Compact 7 operating system
- ▶ Coordinated, preconfigured HMI packages for efficient project planning
- ▶ PMI 6 Assistant for straightforward software package installation
- ▶ Enhanced manufacturing quality and high cycle counts thanks to high performance
- ▶ Large memory for realizing complex applications

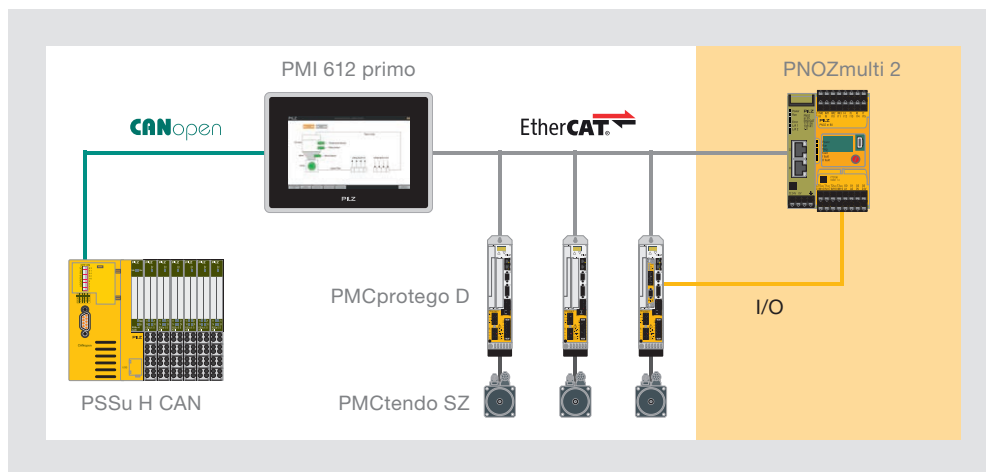

## Common features

- ▶ Motion control: dynamic curve calculation and CNC
- ▶ Display: graphic color TFT, LED backlight
- ▶ Master systems: CANopen, Modbus/TCP, EtherCAT
- ▶ Interfaces: 1 x RS232, 2 x RJ45ETH, 1 x SD card, 2 x USB 2.0
- ▶ Fieldbus interfaces: CAN, EtherCat
- ▶ Operating system: Windows Embedded Compact 7
- ▶ Processor: Intel 1.3 GHz, x86
- ▶ Memory: 512 MB RAM, 512 MB Flash
- ▶ Supply voltage: 24 VDC
- ▶ Ambient temperature: 0 ... 50 °C
- ▶ Battery-buffered real-time clock
- ▶ Protection type: IP65 front, IP20 rear
- ▶ Package contains: configuration stand and application memory (SDHC card 4 GB) with PMI 6 Assistant
- ▶ CODESYS Runtime and Target Visu preinstalled and licensed

## Order number

265 608

265 613

264 639

Keep up-to-date on operator terminals PMI 6 primo:

Webcode:  
web150595

Online information at [www.pilz.com](http://www.pilz.com)

# ▶ Technical details – PMCprimo DriveP

## Safe drive-based motion control system PMCprimo DriveP



PMCprimo DriveP

Technical details		Options
<b>Motion control card PMCprimo C2</b> <ul style="list-style-type: none"> <li>▶ Processor: Intel Atom 1.3 GHz</li> <li>▶ Digital inputs: 8</li> <li>▶ Digital outputs 0.5 A: 8</li> <li>▶ Encoder inputs: 1 (incr. or absolute); mini I/O female connector</li> <li>▶ CANopen Master: 2/1</li> <li>▶ PROFIBUS-DP-S: 0/1</li> <li>▶ Ethernet Modbus TCP (Client): 1</li> <li>▶ USB</li> <li>▶ RAM: 128/512 MB</li> <li>▶ Memory applications: 256 MB</li> <li>▶ Non-volatile memory: 512 kB</li> </ul>	<b>Servo amplifier PMCprotego D</b> <ul style="list-style-type: none"> <li>▶ Position controller with max. 200 motion tasks</li> <li>▶ Electronic gearing</li> <li>▶ Master-Slave mode</li> <li>▶ Encoder emulation</li> <li>▶ Universal voltage range</li> <li>▶ Intermediate circuits can be connected in parallel</li> <li>▶ Encoder: up to 2 encoder inputs, 3 encoder inputs with additional card, 1 encoder output if one encoder input is omitted</li> <li>▶ Digital inputs: 2 x 5 µs, 2 x 250 µs, 2 x STO Enable</li> <li>▶ 2 x digital inputs or outputs: 250 µs</li> <li>▶ Analog inputs: 2 x 16 Bit, ±10 V</li> <li>▶ CANopen profiles (DS301, DS402)</li> <li>▶ Serial interface RS 232</li> <li>▶ Read/write device for SD card (SD Memory Card 512 MB, order number: 313100)</li> <li>▶ Safe Torque Off (STO) up to SIL 3 of EN/IEC 62061, PL e of EN ISO 13849-1</li> <li>▶ Integrated mains filter</li> <li>▶ Internal brake resistor (size 01 ... 24)</li> <li>▶ Protection type: IP20</li> <li>▶ Mounting position: vertical</li> <li>▶ CE certification and UL approval</li> <li>▶ TÜV-approved safety</li> </ul>	<b>Hardware options:</b> <ul style="list-style-type: none"> <li>▶ As an option, slot 3 of the servo amplifier PMCprotego D can be configured with:                             <ul style="list-style-type: none"> <li>- PMCprotego S1-2</li> <li>- PMCprotego S2-2</li> <li>- Posl/O with fast bidirectional 5 V I/O for position encoder emulation (ROD or SSI) or RS 485 signals for encoder control or Master/Slave</li> <li>- Posl/O-AIO for Posl/O functions; Analog input ±10 V, 16 Bit; Analog output ±10 V, 16 Bit</li> </ul> </li> </ul> <b>Software options:</b> <ul style="list-style-type: none"> <li>▶ Dynamic curve calculation</li> <li>▶ Soft PLC in accordance with EN/IEC 61131-3</li> <li>▶ Path interpolation</li> </ul>

**Type code**

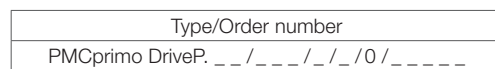

Current A	Size	Slot 1/2	Hardware:	CC0	CC1	CC2	CCC	CCD	CD0	CD1	CD2	CDCC	CCDD	
1.5	01	Slot 1/2	CC PMCprimo C2: 1.3 GHz CANopen/CANopen											
3	03		CD PMCprimo C2: 1.3 GHz CANopen/PROFIBUS DP											
6	06	Slot 3	0 Without											
12	12 <sup>1)</sup>		1 Posl/O <sup>2)</sup>											
24	24 <sup>1)</sup>		2 Posl/O-AIO <sup>3)</sup>											
48	48 <sup>4)</sup>		C PMCprotego S1-2											
72	72 <sup>4)</sup>		D PMCprotego S2-2											

We reserve the right to change technical details

Features	Unit	Size (other sizes in preparation)								
		01	03	06	12	12P	24	24P	48	72
<b>Nominal data</b>										
Mains voltage (power)	VAC	3 x 208 ... 3 x 480 V ±10 %								
Frequency range	Hz	50 ... 60								
Max. motor voltage	VAC	Mains voltage less 4 V					Mains voltage less 6 V			
Continuous output current (at 400 VAC)	A <sub>eff</sub>	1.5	3	6	12		24		48	72
Peak output current (max. 2 s)	A <sub>eff</sub>	4.5	9	18	24	30	48	72	96	140
Peak output current (max. 5 s)	A <sub>eff</sub>	3	6	12	24	24	48		96	140
Power consumption in S1 mode	kVA	1.1	2.2	4.5	9		18		35	50
Output stage clock frequency at I <sub>rms</sub>	kHz	8/16 (50% I <sub>rms</sub> )								
Supply voltage (electronics/with brake)	VDC	24 0 ... +15% (approx. 1 A/max. 3 A)							(approx. 2 A/max. 5 A)	
Power dissipation at I <sub>rms</sub>	W	40	70	100	160		330		635	1 005
<b>Ballast circuit</b>										
Internal brake resistor:										
Continuous output	W	50		75	100		200		-	
Max. peak output for max. 1 s	kW	15					23		-	
External brake resistor:	Ω	33					23		15	10
Max. continuous output	kW	0.3	1		1.5		4		6	6
Max. peak output for max. 5 s	kW	4 ... 21					6 ... 30		16 ... 70	16 ... 70
<b>Environmental conditions</b>										
Ventilation		Forced ventilation through built-in fans								
Ambient temperature	°C	0 ... +40 at rated power, +40 ... +55 with power derating 2.5%/K								
Rel. humidity during operation	%	85, non-condensing								
Storage temperature	°C	-25 ... +55								
Installation height	m above sea level	Up to 1 000 at rated power, 1 000 ... 2 500 with current reduction of around 1.5%/100 m								
<b>Mechanics</b>										
Weight	kg	4.4					5.5		13	
Dimensions (excl. connector)	Height	345					348		385	
	Width	70					100		190	
	Depth	243								



Further technical details in the operating manuals:  
- PMCprotego D  
- PMCprimo C

Drive technology PMC

Software option	2	3	4	5	6	7
Without						
Dynamic curve calculation						
EN/IEC -61131-3 programming						
Path interpolation						

Series	Mains voltage <sup>5)</sup>
230 V	110 ... 230 VAC
480 V	208 ... 480 VAC

Options	0	P
Standard		
I <sub>peak</sub> = 3x <sup>1)4)</sup>		

- <sup>1)</sup> Devices with increased peak output current, see Options
- <sup>2)</sup> Expansion card without analog inputs/outputs
- <sup>3)</sup> Expansion card with analog inputs/outputs
- <sup>4)</sup> Devices with supply voltage series 230 V not available
- <sup>5)</sup> Series 230 V without, series 480 V with UL listing

## ► Technical details – PMCprimo MC

### Motion control system PMCprimo MC



PMCprimo MC

#### Technical details

- ▶ CPU 1.3 GHz
- ▶ 1 Ethernet port
  - Modbus TCP for devices/device communication
  - TCP/IP for programming
- ▶ EtherCAT
- ▶ Interfaces: 4 x CANopen
- ▶ Alternative configuration: 3 x CANopen + 1 x PROFIBUS-DP-S (DPV0)
- ▶ USB interface for data backup (external USB stick)
- ▶ 16 digital inputs:
  - of which 6 x input filters can be set 5 μs/600 μs
- ▶ 16 digital outputs, 0.5 A
- ▶ I/O on the servo amplifier can be used
- ▶ 3 x encoder input incremental/SSI
- ▶ Memory: remanent (512 KB), RAM (512 MB), application (512 MB)
- ▶ Up to 30 subscribers available
- ▶ Freely definable synchronization between axes and encoder:
  - Electronic gearing (linear/non-linear)
  - Master-Slave mode
- ▶ Print mark detection
- ▶ Freely programmable
- ▶ Unlimited number of target positions

#### Options

- ▶ Dynamic curve calculation
- ▶ Soft PLC in accordance with EN/IEC 61131-3
- ▶ Path interpolation

#### Type code

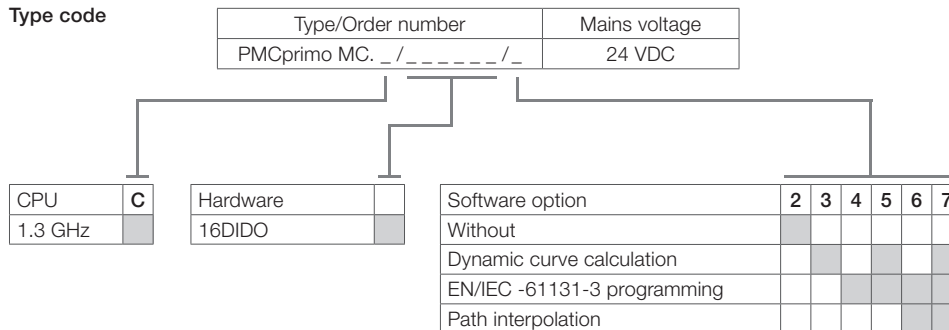

We reserve the right to change technical details

Features		Unit	Performance data
<b>Nominal data</b>			
Supply voltage		VDC	24
Voltage tolerance		%	-15/+20
<b>Environmental conditions</b>			
Cooling			Fan
Ambient temperature		°C	0 ... +40
Rel. humidity during operation		%	93 % r.h. at 40 °C
Storage temperature		°C	-40 ... +70
Max. operating height above sea level		m	2 000
Airgap creepage (EN 61131-2)			2
- Pollution degree			II
- Overvoltage category			
<b>Mechanics</b>			
Dimensions (excl. connector)	Height	mm	270.6
	Width	mm	60
	Depth	mm	183

Further technical details in the operating manual



## ▶ Servo amplifier PMCprotego D

Intelligent servo amplifiers from Pilz are used as drive controllers for the widest range of motor technologies. They can be used to operate all common types of motors, from servo motors to asynchronous and linear motors, including rotary direct drives, linear servo motors and applications with special motors. Take advantage of the benefits of the servo amplifier during design, control, application and operation.

These modern servo amplifiers do much more than just drive the motor:

- ▶ Positioning (driven via bus or inputs)
- ▶ Ability to store up to 200 motion tasks
- ▶ Implementation of complex motion sequences through motion tasks
- ▶ Speed control
- ▶ Torque control
- ▶ Electric gear function

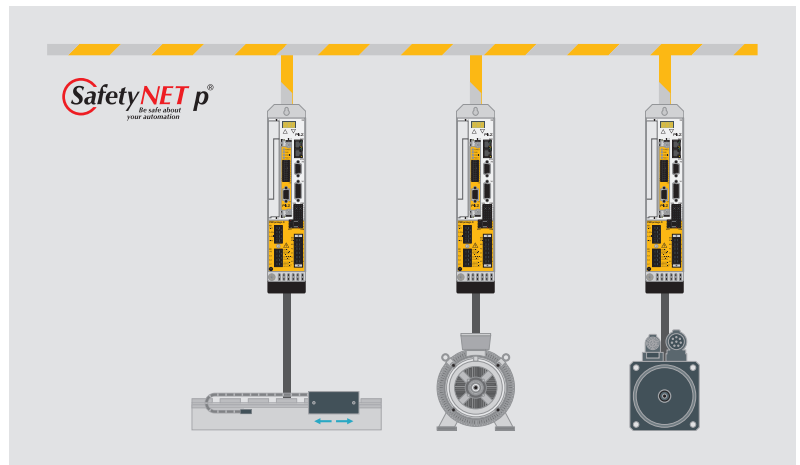

Servo amplifiers PMCprotego D can be used with the widest range of motor technologies.

### Universal application

The servo amplifiers PMCprotego D are designed for stand alone operation. Even the basic version provides all the functions necessary to operate a brushless motor in asynchronous or synchronous technology. More than 20 different feedback systems can be connected directly for operating the widest range of motor technologies. The servo amplifiers are compatible with a wide range of control systems thanks to the optional bus cards.

### Selection guide – Servo amplifier PMCprotego D

Type	Rated current	Power supply
PMCprotego D	1.5 ... 72 A	208 ... 480 VAC

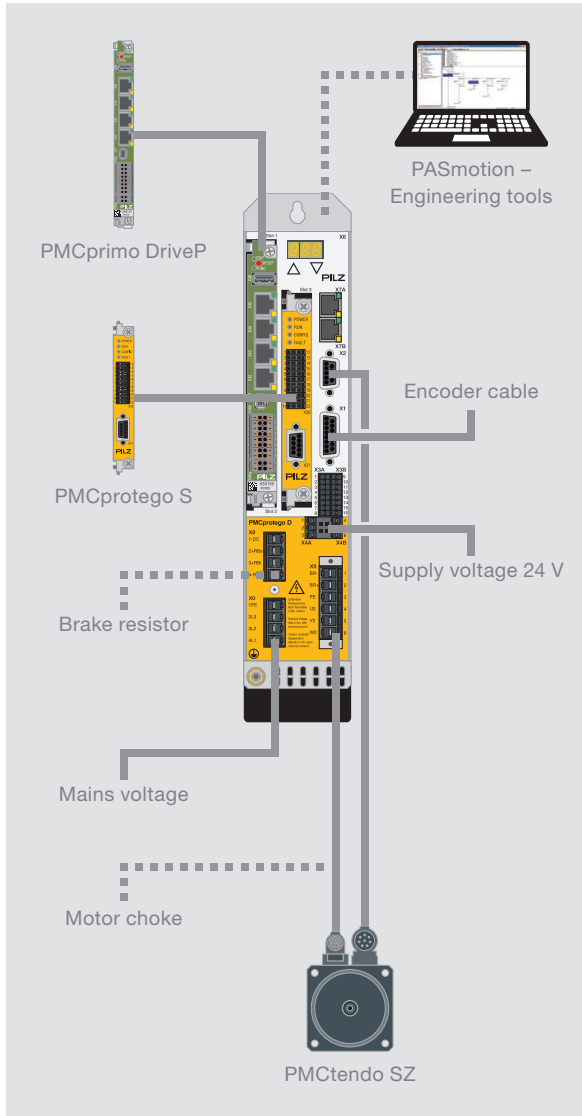

Selection guide PMcpratego D

**Open for option cards**

Expansion cards for fieldbus systems or PLCs can simply be plugged into the option slot on the servo amplifier. As a result, all amplifier functions can be accessed directly. The intermediate circuit connection with intelligent ballast circuit enables an optimum energy balance. So frequently there is no need for external brake resistors, even on critical axes.

**Safe motion and motion control can be integrated**

All servo amplifiers include the "Safe Torque Off" function, even in their basic configuration. The safety card PMcpratego S is used for additional safety functions.

The motion control system PMcprimo C2 can also be integrated into the servo amplifier as a plug-in card, creating the all-in-one motion control solution from Pilz.

Size	Safe torque off	Additional safe drive functions	
		External solution	Drive-integrated solution
Standard	◆	◆	◆

Servo amplifier  
PMcpratego D

Webcode:  
web150508

Online information  
at [www.pilz.com](http://www.pilz.com)

# ▶ Technical details – PMCprotego D

## Servo amplifier PMCprotego D



PMCprotego D  
(size 01 ... 12)



PMCprotego D  
(size 48/72)

Technical details	Options
<ul style="list-style-type: none"> <li>▶ Position controller with max. 200 motion tasks</li> <li>▶ Electronic gearing</li> <li>▶ Master-Slave mode</li> <li>▶ Encoder emulation</li> <li>▶ Universal voltage range</li> <li>▶ Intermediate circuits can be connected in parallel</li> <li>▶ 2 encoder inputs</li> <li>▶ 1 encoder output</li> <li>▶ 2 digital inputs, STO Enable</li> <li>▶ 2 digital inputs, 5 μs</li> <li>▶ 2 digital inputs, 250 μs</li> <li>▶ 2 digital inputs or outputs, 250 μs</li> <li>▶ 2 analog inputs ±10 V, 16 Bit</li> <li>▶ CANopen                             <ul style="list-style-type: none"> <li>- DS301 communication profile</li> <li>- DS402 drive profile</li> </ul> </li> <li>▶ Ethernet-based bus communication EtherCAT</li> <li>▶ Serial interface RS 232</li> <li>▶ Read/write device for SD card (SD Memory Card 512 MB, order number: 313 100)</li> <li>▶ Safe Torque Off (STO) up to SIL 3 of EN/IEC 62061, PL e of EN ISO 13849-1</li> <li>▶ Integrated mains filter</li> <li>▶ Internal brake resistor (size 01 ... 24)</li> <li>▶ Protection type: IP20</li> <li>▶ Mounting position: vertical</li> <li>▶ CE certification and UL approval</li> <li>▶ TÜV-approved safety</li> </ul>	<ul style="list-style-type: none"> <li>▶ As an option, slot 1 can be configured with:                             <ul style="list-style-type: none"> <li>- D1 I/O expansion card with 14 inputs and 8 outputs</li> <li>- Fieldbus: PROFIBUS-DP-S</li> <li>- PMC expansion card PROFINET</li> </ul> </li> <li>▶ As an option, slot 2 can be configured with:                             <ul style="list-style-type: none"> <li>- Posl/O with fast bidirectional 5 V I/O for position encoder emulation (ROD or SSI) or RS 485 signals for encoder control or Master/Slave</li> <li>- Posl/O monitor for Posl/O-AIO functions; 2 analog inputs ±10 V, 16 Bit; 2 analog outputs ±10 V, 16 Bit</li> </ul> </li> <li>▶ Slot 3 optionally configurable with safety card:                             <ul style="list-style-type: none"> <li>- PMCprotego S1-2</li> <li>- PMCprotego S2-2</li> <li>- Posl/O with fast bidirectional 5 V I/O for position encoder emulation (ROD or SSI) or RS 485 signals for encoder control or Master/Slave</li> <li>- Posl/O monitor for Posl/O functions; analog input ±10 V, 16 Bit; analog output ±10 V, 16 Bit</li> </ul> </li> <li>▶ Coated: increased protection from particle-loaded ambient air</li> <li>▶ Increased peak output current: <math>I_{peak} = 3 \times I_{nenn}</math> for size 12 and 24</li> </ul>

### Type code

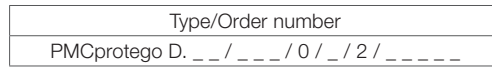

Current A	Size
1.5	01
3	03
6	06
12	12 <sup>1)</sup>
24	24 <sup>1)</sup>
48	48 <sup>4)</sup>
72	72 <sup>4)</sup>

Hardware option		000	100	200	A00	101	201	A01	102	202	A02	10C	20C	A0C	10D
Slot 1	0 Without														
	1 I/O expansion														
	2 PROFIBUS														
	A PROFINET														
Slot 2	0 Without														
	1 Posl/O <sup>2)</sup>														
	2 Posl/O-AIO <sup>3)</sup>														
Slot 3	0 Without														
	1 Posl/O <sup>2)</sup>														
	2 Posl/O-AIO <sup>3)</sup>														
	C PMCprotego S1-2														
	D PMCprotego S2-2														
	E PMCprotego S1-2-C <sup>5)</sup>														
F PMCprotego S2-2-C <sup>5)</sup>															

We reserve the right to change technical details





## ▶ Safe motion – safety card PMCprotego S

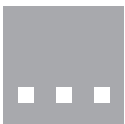
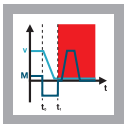
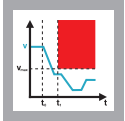
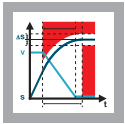

The combination of the safety card PMCprotego S and the servo amplifier PMCprotego D produces the safe drive solution – safe motion. It is open for all standard PLC and motion control systems. Benefit from the high flexibility of our solution.



Safe motion – Safety card PMCprotego S.

### Protection of man and machine

Safe motion describes the implementation of safety functions for one or more drive axes. This is necessary to prevent uncontrollable movements. At the same time it guarantees the safety of personnel during operation, setup, format change or maintenance.

### Open for individual requirements

The PMCprotego DS provides safe inputs and outputs to activate the safety functions. It also provides a variety of encoder interfaces plus a connection to common bus systems.

### Economical operation

Safe motion opens up new possibilities for co-operation between human and machine. For example, it's possible to set up machinery at "Safely Reduced Speed". This reduces the setup time and increases the availability of the process.

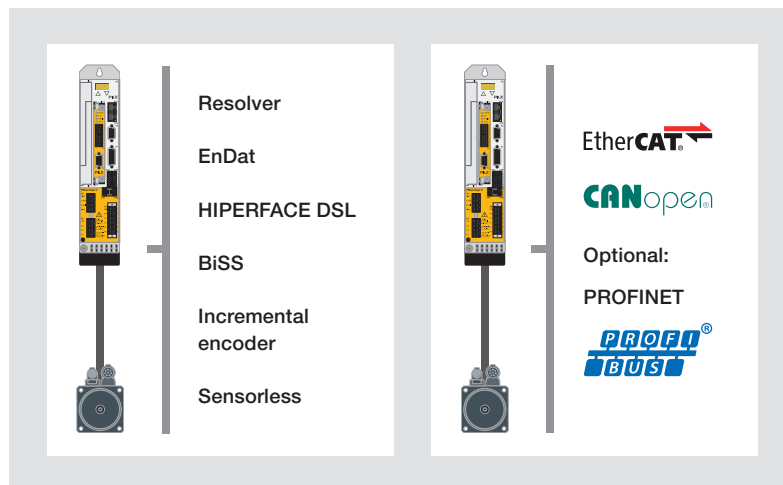

### Complete one-stop automation solution

With the safety card PMCprotego S, the automation solution from Pilz is complete. You benefit from a complete one-stop solution. Compatible products and tools reduce the work involved in training and documentation. Optimum integration of the safety card PMCprotego S brings significant cost savings.

Openness thanks to a variety of encoder interfaces and bus systems.

**Safety with a standard encoder**

Safety on the servo amplifier PMCprotego DS is based on the evaluation of internal system variables. The servo motor's existing standard feedback system is all that's needed for implementation. A second encoder is not required in order to achieve SIL 3, PL e, which reduces the overall costs.

**Safe networking**

Safe, sophisticated multi-axis applications are the result when the PMCprotego DS is connected to the control system.

**Simple diagnostics**

Thanks to the PVIS diagnostic concept, system messages from the safe servo amplifiers PMCprotego DS are displayed in plain text on the diagnostic device PMI via the motion controller PMCprimo. Remedy messages are displayed for each event. PVIS significantly reduces downtimes in the case of a fault. Thanks to pre-defined messages, even project configuration is simple.

**Reduced reaction times**

The servo amplifiers PMCprotego DS have integrated safety functions, opening up new possibilities for safe drive solutions. Motion is monitored precisely where it arises. Reaction times are reduced considerably as a result. This is very significant for safety, particularly with highly dynamic drives. Costs are reduced at the same time, as there are fewer external safety components.

**Your benefits at a glance**

- ▶ Highly dynamic, short reaction times
- ▶ Costs are reduced because the highest safety category PL e is achieved with one encoder (standard feedback system)
- ▶ Simple, fast commissioning
- ▶ Easy-to-use software tool
- ▶ Devices are easy to exchange thanks to the SD memory card (standard and safety configuration)
- ▶ Integrated diagnostics PVIS
- ▶ Less wiring
- ▶ Greater functionality and convenience, as internal system variables can be used
- ▶ Integrated mains filter enables costs to be reduced as the wiring work is no longer required (EMC standards are met)

**Centralized view of decentralized safety –**

**One tool covers every axis**

The parameters for several safety cards are set centrally via a software tool. The cards that are used are displayed in a tree structure. Thanks to the clear graphical interface, parameters can be set simply and quickly. The current status of the safety card can be displayed online. This means that the operating status, error stack and other data can be monitored continuously.

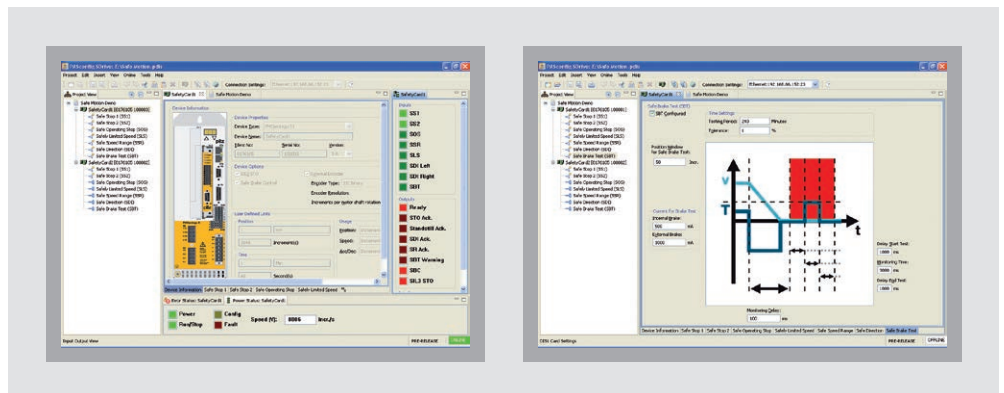

Clear user interface for simple parameter setting.

## ▶ Technical details – PMCprotego S

### Safety cards PMCprotego S

#### Common features

- ▶ Electrical data
  - External supply voltage  $U_B$ : 24 VDC
  - Power consumption (with no load): approx. 3 W
- ▶ Inputs
  - Galvanic isolation: Yes
  - Signal level at "0": -3 ... 5 V
  - Signal level at "1": 15 ... 30 V
- ▶ Single-pole/dual-pole outputs
  - Galvanic isolation: Yes
  - Electronic short circuit protection: Yes
  - Signal level at "0": 0 VDC
  - Signal level at "1": 24 VDC
- ▶ Environmental data
  - Protection type: IP20
  - Ambient temperature: 0 ... 40 °C
  - Storage temperature: -25 ... +55 °C
- ▶ Mechanical data
  - Dimensions in mm (H x W x D): 142 x 103 x 18.5
  - Installation: in PMCprotego D, Slot 3
  - Weight: 150 g



PMCprotego S

Features
Reaction times
Inputs/outputs (single-pole)
Output to control an external brake (dual-pole)
Brake
Encoder input
Standards
Coating (-C)
Safety functions
Order number

We reserve the right to change technical details





	PMCprotego S1-2/(-C)	PMCprotego S2-2/(-C)
Error reaction time in ms	2	3
Response time of the safety functions in ms	4	5
Number of inputs	9	8
Number of single-pole outputs 0.5 A	7	5
Number of dual-pole outputs 2 A	1	-
Galvanic isolation	Yes	-
Control external brake < 2 A	via PMCprotego S1	-
Control external brake > 2 A	via external brake module	-
Number of external encoders	1 <sup>1)</sup>	-
Encoder type	SSI/incremental encoder	-
	SIL CL 3 of EN/IEC 62061, PL e of EN ISO 13849-1	SIL CL 2 of EN/IEC 62061, PL d of EN ISO 13849-1
	Uncoated / (coated)	Uncoated / (coated)
Safe Torque Off (STO)	◆	◆
Safe Stop 1 (SS1)	◆	◆
Safe Stop 2 (SS2)	◆	◆
Safe Operating Stop (SOS)	◆	◆
Safely Limited Speed (SLS)	◆	◆
Safe Speed Range (SSR)	◆	◆
Safe Direction (SDI)	◆	◆
Safely Limited Increment (SLI)	◆	◆
Safely Limited Position (SLP)	◆ <sup>1) 2)</sup>	
Safe Brake Control (SBC)	◆	
Safe Brake Test (SBT)	◆	
	680 004 / (680 008)	680 006 / (680 009)

<sup>1)</sup> The Pilz solution is already safe with the servo motor's feedback system.  
If the risk assessment of the mechanical drive train requires a second encoder,  
a second, external encoder can be connected.

<sup>2)</sup> Requires the connection of an additional encoder.

## ▶ Servo motors PMCtendo SZ with HIPERFACE DSL®



With the servo motors PMCtendo SZ, you'll find the right motor for each individual application. Whether the focus is on dimensions, dynamics, controllability or feedback systems. The purely digital motor feedback protocol HIPERFACE DSL is available for the servo motors. It only requires a cable between the servo amplifier and motor and thereby supports the single-cable technique in drive technology.



PMCtendo SZ  
(HIPERFACE DSL)



PMCtendo SZ  
(convection-cooled)



PMCtendo SZ  
(forced air-cooled)

### Good controllability

The excellent controllability of the PMCtendo SZ motors is achieved using the high resolution absolute encoder as a feedback system. Through this you can read out the absolute position of the motors during operation. Even when the machine has been switched off or there is a power failure, the absolute position will still be available.

### More than just motors

All motors are available with a range of gearings. Special versions, forced air fans etc. are also available.

### Support with your motor design

Different motor sizes are available in the standard product range. On request we can also supply customized solutions. And of course, Pilz application engineers will provide support with the motor design and definition of the power transmission.

### Compact design, high performance

Thanks to their high power density, the servo motors PMCtendo SZ have an extremely short overall length and are also lightweight. As a result they are particularly suitable where conditions are cramped and for on-board axes. Precise motor synchronization, due to low cogging torques, provides constantly high process quality.

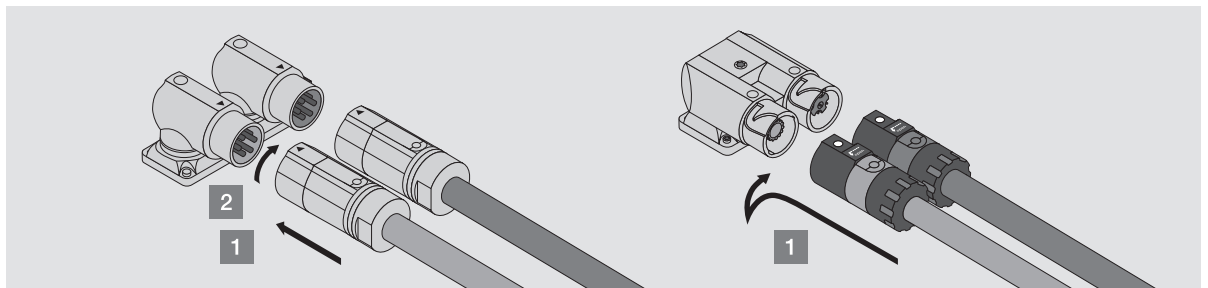

Servo motors PMCtendo can be commissioned quickly using quick-lock speedtec and springtec connectors.

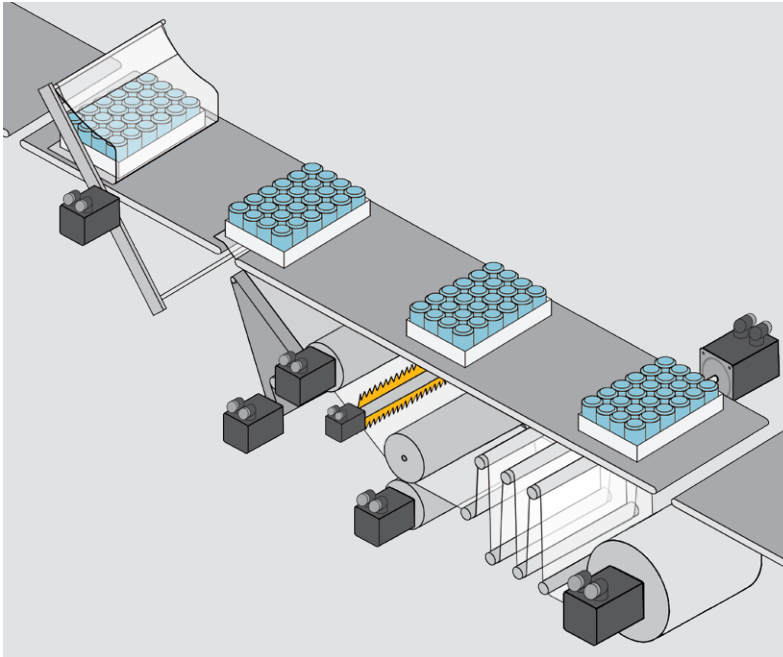

The appropriate, decentralized drive for every detail.

#### Your benefits at a glance

- ▶ Cost savings, reduced space requirement and less installation work thanks to single-cable technique
- ▶ High power density due to the very short overall length
- ▶ Extremely quiet operation and high process quality due to the low cogging torques
- ▶ Maximum cycle rate/machine output thanks to the highest dynamics
- ▶ Best heat dissipation generates permanently high performance
- ▶ High-resolution absolute value encoder systems for highest performance and absolute positioning
- ▶ Ideal for use with on-board axes and in cramped conditions
- ▶ Energy saving (IE4) due to high efficiency factor

#### Selection guide – Servo motors PMctendo SZ

Type	Standstill torque		Rated speed $n_N$ in rpm	Flange in mm
	Convection $M_0$ in Nm	Forced air fan $M_0$ in Nm		
PMctendo SZ3x	0.95 ... 2.25	-	3 000, 6 000	60
PMctendo SZ4x	2.80 ... 8.60	3.5 ... 11.2	3 000, 6 000	95
PMctendo SZ5x	4.40 ... 16.00	5.7 ... 23.4	3 000, 4 500	110
PMctendo SZ7x	7.90 ... 30.20	10.2 ... 41.8	3 000, 4 500	130
PMctendo SZ8x	34.50 ... 66.10	47.4 ... 94.0	2 000, 3 000, 4 500	180

Accessories for drive technology PMC:

 Webcode:  
web215410

Keep up-to-date on servo motors PMctendo SZ:

 Webcode:  
web150384

Online information at [www.pilz.com](http://www.pilz.com)

## ► Technical details – PMctendo SZ

### Servo motors PMctendo SZ



PMctendo SZ



#### General technical details

- ▶ Extremely short overall length
- ▶ Smooth shaft
- ▶ High dynamics due to low inertia
- ▶ Rotary speedtec connector
- ▶ Therm. winding protection PTC
- ▶ Protection type: IP56
- ▶ Surface: black, matt RAL 9005
- ▶ EnDat absolute encoder: single-turn or multi-turn
- ▶ HIPERFACE DSL: multiturn
- ▶ UL approval and CSA certification for the motor insulation system

#### Options

- ▶ Holding brake: 24 VDC
- ▶ Increased inertia
- ▶ Protection type: IP66
- ▶ External IP44 fan to IC416

#### Motor size

#### Common dimensions in mm

Motor size	Common dimensions in mm		
	øb1 <sup>1)</sup>	øe1 <sup>2)</sup>	ød <sup>3)</sup>
31	60j6	75	14k6
32	60j6	75	14k6
33	60j6	75	14k6
41	95j6	115	14k6
42	95j6	115	19k6
44	95j6	115	19k6
51	110j6	130	19k6
52	110j6	130	19k6
53	110j6	130	24k6
55	110j6	130	24k6
71	130j6	165	24k6
72	130j6	165	24k6
73	130j6	165	24k6
75	130j6	165	32k6
82	180j6	215	32k6
83	180j6	215	38k6
85	180j6	215	38k6

The performance data in the tables below refers to the following boundary conditions:

- ▶ Rated voltage: 400 V
- ▶ Operating mode: S1 at rated operation
- ▶ Maximum heating: 100 K
- ▶ Cooling: Convection in accordance with IC410
- ▶ Ambient temperature: Convection cooling: -15 ... +40 °C
- ▶ Heat class: F
- ▶ Installation height up to 1 000 m above sea level

#### Convection-cooled:

PMctendo SZ:  
convection-cooled, without brake

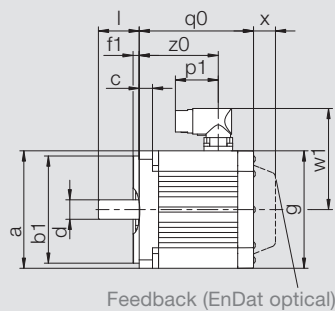

PMctendo SZ:  
convection-cooled, with brake

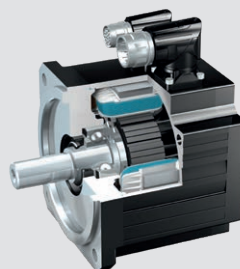
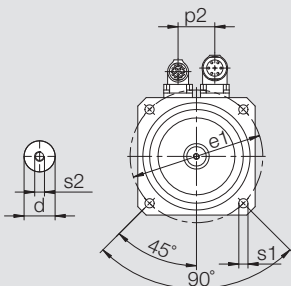
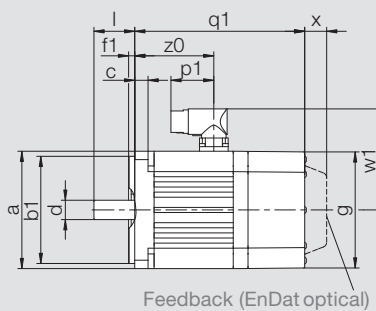

#### Forced air-cooled:

PMctendo SZ:  
forced air-cooled, without brake

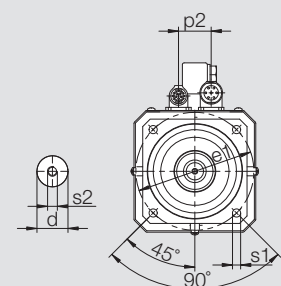
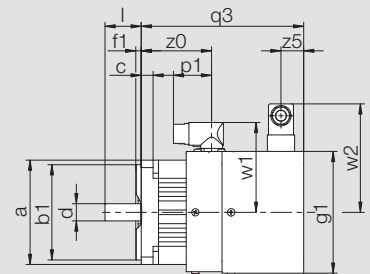



l	a	c	f1	p1	p2	øS1	øS2	w1	z0	Convection-cooled				Forced air-cooled				
										g	q0	q1	x	g1	q3	q4	w2	z5
30	72	7.0	3.0	45	19	6	M5	56	80.5	72	116.0	156.0	21	-	-	-	-	-
30	72	7.0	3.0	45	19	6	M5	56	102.5	72	138.0	178.0	21	-	-	-	-	-
30	72	7.0	3.0	45	19	6	M5	56	124.5	72	160.0	200.0	21	-	-	-	-	-
30	98	9.5	3.5	40	32	9	M5	91	76.5	98	118.5	167.0	22	118	175	224	111	25
40	98	9.5	3.5	40	32	9	M6	91	101.5	98	143.5	192.0	22	118	200	249	111	25
40	98	9.5	3.5	40	32	9	M6	91	151.5	98	193.5	242.0	22	118	250	299	111	25
40	115	10.0	3.5	40	36	9	M6	100	74.5	115	109.0	163.5	22	135	179	234	120	25
40	115	10.0	3.5	40	36	9	M6	100	99.5	115	134.0	188.5	22	135	204	259	120	25
50	115	10.0	3.5	40	36	9	M8	100	124.5	115	159.0	213.5	22	135	229	284	120	25
50	115	10.0	3.5	40	36	9	M8	100	174.5	115	209.0	263.5	22	135	279	334	120	25
50	145	10.0	3.5	40	42	11	M8	115	83.0	145	121.0	180.0	22	165	213	272	134	40
50	145	10.0	3.5	40	42	11	M8	115	108.0	145	146.0	205.0	22	165	238	297	134	40
50	145	10.0	3.5	40	42	11	M8	115	133.0	145	171.0	230.0	22	165	263	322	134	40
58	145	10.0	3.5	71	42	11	M12	134	184.0	145	226.0	285.0	22	165	318	377	134	40
58	190	15.0	3.5	71	60	13.5	M12	157	168.0	190	222.0	299.0	22	215	322	399	160	40
80	190	15.0	3.5	71	60	13.5	M12	157	209.0	190	263.0	340.0	22	215	363	440	160	40
80	190	15.0	3.5	71	60	13.5	M12	157	291.0	190	345.0	422.0	22	215	445	522	160	40

<sup>1)</sup> Centering <sup>2)</sup> Bolt hole <sup>3)</sup> Shaft

PMctendo SZ:  
forced air-cooled, with brake

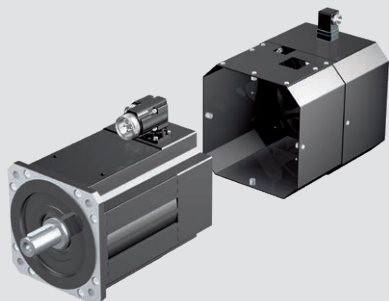
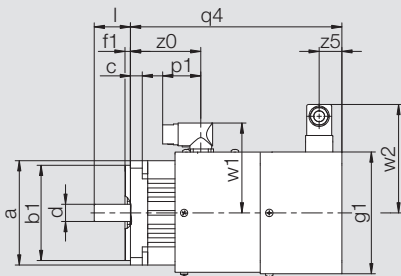

## ► Technical details – PMctendo SZ

### Performance data PMctendo SZ convection-cooled

Motor size	Rated speed	Constant standstill torque	Rated torque	Peak torque	Moment of inertia Without brake	Torque constant	Constant standstill current (eff.)
	$n_N$ rpm	$M_0$ Nm	$M_N$ Nm	$M_{max}$ Nm	$J$ $10^{-4}$ kgm <sup>2</sup>	$K_M$ Nm/A	$I_0$ A
31	6 000	0.95	0.89	2.8	0.19	0.490	2.02
	3 000	0.95	0.93	2.8	0.19	0.490	2.02
32	6 000	1.68	1.5	5.0	0.29	0.494	3.48
	3 000	1.68	1.59	5.0	0.29	1.030	1.67
33	6 000	2.25	1.96	7.0	0.40	0.645	3.55
	3 000	2.19	2.07	7.0	0.40	1.304	1.71
41	6 000	2.8	2.3	8.5	0.93	0.530	5.36
	3 000	3.0	2.8	8.5	0.93	1.056	2.88
42	6 000	4.9	3.5	16.0	1.63	0.665	7.43
	3 000	5.2	4.7	16.0	1.63	1.092	4.80
44	6 000	8.4	5.8	29.0	2.98	0.863	9.78
	3 000	8.6	6.9	29.0	2.98	1.309	6.60
51	6 000	4.4	3.4	16.0	2.90	0.769	5.80
	3 000	4.7	4.3	16.0	2.90	1.190	4.00
52	6 000	7.8	5.2	31.0	5.20	0.802	9.80
	3 000	8.0	7.4	31.0	5.20	1.399	5.76
53	6 000	10.6	6.2	43.0	7.58	0.921	11.60
	3 000	11.1	9.7	43.0	7.58	1.455	7.67
55	4 500	15.3	9.5	67.0	12.20	1.148	13.40
	3 000	16.0	13.5	67.0	12.20	1.606	10.00
71	6 000	7.9	5.2	20.0	8.50	0.868	9.38
	3 000	8.3	7.4	20.0	8.50	1.068	8.00
72	6 000	14.3	7.2	41.0	13.70	0.879	16.50
	3 000	14.4	12.0	41.0	13.70	1.525	9.60
73	4 500	20.0	12.1	65.0	21.60	1.137	17.80
	3 000	20.8	16.5	65.0	21.60	1.503	14.00
75	4 500	30.0	16.4	104.0	34.00	1.200	25.20
	3 000	30.2	21.3	104.0	34.00	1.561	19.50
82	4 500	34.5	10.5	100.0	58.00	1.045	33.30
	3 000	37.1	22.3	100.0	58.00	1.677	22.30
83	3 000	48.2	26.6	145.0	83.50	1.559	31.10
85	2 000	66.1	43.7	205.0	133.00	1.752	37.90

All technical details are values for the dynamic version of motors.  
 All the stated data applies to motors with a rated voltage of 400 V.  
 We reserve the right to amend technical details.

Peak current (eff.)	Rated output	EMF voltage constant	Weight Without brake
$I_{max}$ A	$P_N$ kW	$K_E$ V/1 000 rpm	m kg
12.7	0.56	40	1.5
12.7	0.29	40	1.5
17.8	0.94	42	2.1
8.55	0.50	86	2.1
16.9	1.20	55	2.6
8.25	0.65	109	2.6
33.0	1.40	47	4.0
16.5	0.88	96	4.0
43.5	2.20	60	5.1
26.5	1.50	94	5.1
51.0	3.60	78	7.2
35.0	2.20	116	7.2
31.0	2.10	68	5.0
22.0	1.40	97	5.0
59.0	3.30	72	6.5
33.0	2.30	121	6.5
63.5	3.90	84	8.0
41.0	3.10	119	8.0
73.0	4.50	103	10.9
52.0	4.20	141	10.9
31.0	3.30	76	8.3
25.0	2.30	95	8.3
60.5	4.50	82	10.8
36.0	3.80	133	10.8
78.0	5.70	99	12.8
62.0	5.20	122	12.8
114.0	7.70	106	18.3
87.0	6.70	140	18.3
135.0	5.00	90	26.6
84.0	7.00	136	26.6
124.0	8.40	131	32.7
155.0	9.20	142	45.8



Drive technology PMC

## ► Technical details – PM Ctendo SZ

### Performance data PM Ctendo SZ forced air-cooled

Motor size	Rated speed	Constant standstill torque	Rated torque	Peak torque	Moment of inertia without brake	Torque constant	Constant standstill current (eff.)	Peak current (eff.)	Rated output	EMF voltage constant	Weight without brake
	$n_N$ rpm	$M_0$ Nm	$M_N$ Nm	$M_{max}$ Nm	$J$ $10^{-4}$ kgm <sup>2</sup>	$K_M$ Nm/A	$I_0$ A	$I_{max}$ A	$P_N$ kW	$K_E$ V/1 000 rpm	$m$ kg
41	6 000	3.5	2.9	8.5	0.93	0.518	6.83	33.0	1.8	47	5.4
	3 000	3.7	3.4	8.5	0.93	1.039	3.60	16.5	1.1	96	5.4
42	6 000	6.4	5.1	16.0	1.63	0.690	9.34	43.5	3.2	60	6.5
	3 000	6.3	5.9	16.0	1.63	1.093	5.80	26.5	1.9	94	6.5
44	6 000	10.5	8.0	29.0	2.98	0.878	12.00	51.0	5.0	78	8.6
	3 000	11.2	10.2	29.0	2.98	1.292	8.70	35.0	3.2	116	8.6
51	6 000	5.7	4.5	16.0	2.90	0.768	7.50	31.0	2.8	68	7.0
	3 000	5.8	5.4	16.0	2.90	1.172	5.00	22.0	1.7	97	7.0
52	6 000	10.5	8.2	31.0	5.20	0.788	13.40	59.0	5.2	72	8.5
	3 000	11.2	10.3	31.0	5.20	1.380	8.16	33.0	3.2	121	8.5
53	6 000	14.8	10.4	43.0	7.58	1.068	15.9	63.5	6.5	84	10.0
	3 000	15.9	14.4	43.0	7.58	1.353	11.8	41.0	4.5	119	10.0
55	4 500	22.0	16.4	67.0	12.20	1.138	19.4	73.0	7.7	103	12.9
	3 000	23.4	20.2	67.0	12.20	1.596	14.7	52.0	6.4	141	12.9
71	6 000	10.2	7.5	20.0	8.50	0.842	12.4	31.0	4.7	76	13.3
	3 000	10.5	9.7	20.0	8.50	1.074	10.0	25.0	3.1	95	13.3
72	6 000	19.3	12.5	41.0	13.70	0.886	22.1	60.5	7.9	82	15.8
	3 000	19.3	16.6	41.0	13.70	1.515	12.9	36.0	5.2	133	15.8
73	4 500	27.2	19.8	65.0	21.60	1.134	24.2	78.0	9.3	99	17.8
	3 000	28.0	24.0	65.0	21.60	1.412	20.0	62.0	7.5	122	17.8
75	4 500	39.4	27.7	104.0	34.00	1.209	32.8	114.0	13.0	106	23.3
	3 000	41.8	33.8	104.0	34.00	1.586	26.5	87.0	11.0	140	23.3
82	4 500	47.4	30.6	100.0	58.00	1.058	45.1	135.0	14.0	90	31.6
	3 000	47.9	34.3	100.0	58.00	1.668	28.9	84.0	11.0	136	31.6
83	3 000	66.7	49.0	145.0	83.50	1.584	42.3	124.0	15.0	131	37.7
85	2 000	94.0	77.2	205.0	133.00	1.749	53.9	155.0	16.0	142	51.8

All technical details are values for the dynamic version of motors.  
 All the stated data applies to motors with a rated voltage of 400 V.  
 We reserve the right to amend technical details.

Type code

Type/Order number	Size	Brake	Feedback	Design	Connection	Cooling	Voltage	Speed	Option
PM Ctendo SZ.	--	-	-	-	-	-	-	--	--

Dimensions/overall length									
PM Ctendo SZ3x	<b>3x</b>								<b>00</b> Standard
PM Ctendo SZ4x	<b>4x</b>								<b>20</b> 2 000 rpm <sup>1)</sup>
PM Ctendo SZ5x	<b>5x</b>								<b>30</b> 3 000 rpm <sup>1)</sup>
PM Ctendo SZ7x	<b>7x</b>								<b>45</b> 4 500 rpm <sup>1)</sup>
PM Ctendo SZ8x	<b>8x</b>								<b>60</b> 6 000 rpm <sup>1)</sup>

Without brake and dynamic design	<b>0</b>								<b>H</b> 400 V
With brake and dynamic design	<b>1</b>								<b>K</b> Convection-cooled
Without brake and higher mass inertia	<b>2</b>								<b>F</b> Forced air-cooled
With brake and higher mass inertia	<b>3</b>								<b>7</b> Angled swivel connector for motor and feedback

EnDat 2.2 inductive single-turn ECI 1118	<b>1</b>								
EnDat 2.2 optical multi-turn EQN 1135	<b>2</b>								
HIPERFACE DSL multiturm EKM 36	<b>7</b>								

B5, smooth shaft	<b>2</b>								
------------------	----------	--	--	--	--	--	--	--	--

<sup>1)</sup> Size-dependent; see PMC catalog and/or operating manual



## ▶ Operator terminals PMI®

Whether control, diagnostic or visualization tasks: With the operator terminals PMI we offer you the appropriate solutions for your application. Our offer extends from a cost-optimized visualization terminal to complete solutions with Soft PLC. Rely on “made in Germany” quality.

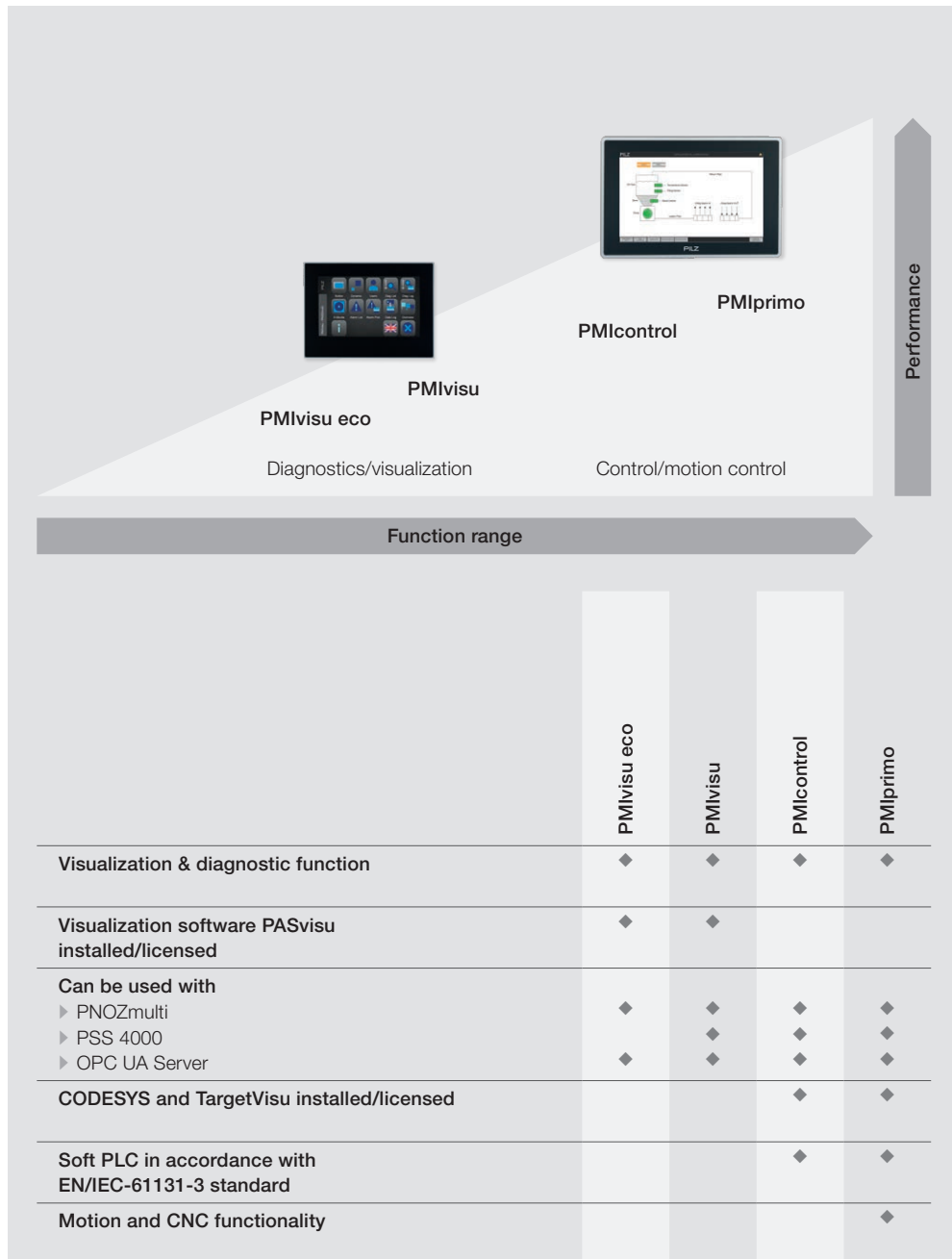



### Product group

#### Operator terminals PMI

- ▶ Visualization panels – PMLvisu eco 176
- ▶ Visualization panels – PMLvisu 176
- ▶ Control panels – PMLcontrol 177
- ▶ Motion control panels – PMLprimo 177
- ▶ Technical details 180

#### Software

- ▶ Visualization software PASvisu 182

## ▶ Operator terminals PMI®

Modern HMI systems for diagnostics, visualization and control – the operator terminals PMI (Pilz Human Machine Interface) enable observation, operation and control of your technical processes and thus form the link between human and machine. Our wide range runs the gamut from visualization terminals with our visualization software PASvisu to control terminals with Soft PLC for demanding applications. In combination with Pilz controllers, you achieve a system that is easy to integrate into your plants and increases the cost effectiveness. After all, good visualization and diagnostics always also mean short downtimes in the event of a fault.

Webcode:  
web160789

Online information  
at [www.pilz.com](http://www.pilz.com)



### **PMIvisu eco – visualization panels with pre-installed visualization software**

The cost-optimized PMIvisu eco operator panels PMI v7e are equipped with the visualization software PASvisu. As a result, the visualization of your machinery can be performed easily with all information at a glance!

- ▶ Visualization software PASvisu installed and licensed
- ▶ Linux operating system
- ▶ Can be connected to PNOZmulti or a third party OPC UA server
- ▶ High-resolution capacitive glass TFT displays
- ▶ Display sizes from 4.3" and 7"
- ▶ Interfaces: 1 x USB
- ▶ PMI Manager

Webcode:  
web160789

Online information  
at [www.pilz.com](http://www.pilz.com)



### **PMIvisu – visualization panels with pre-installed visualization software**

With the PMIvisu operator panels PMI v8 you receive a complete package for professional diagnostics and visualization of plant and machinery with the preinstalled and licensed visualization software PASvisu.

- ▶ Visualization software PASvisu installed and licensed
- ▶ Operating system Windows 10 IoT
- ▶ Can be connected to PNOZmulti and PSS 4000 or a third party OPC UA server
- ▶ High-resolution capacitive glass TFT displays
- ▶ Display sizes from 7" and 12.1"
- ▶ Interfaces: 2 x GbE, 1 x HDMI, 1 x VGA, 1 x USB 3.0, 2 x USB 2.0
- ▶ PMI Assistant





**PMIcontrol – control panels with Soft PLC  
in accordance with EN/IEC 61131-3**

The high-performance PMI 6 control series is equipped with a Soft PLC in accordance with the EN/IEC-61131-3 standard, with visualization. As well as professional diagnostics and visualization, it enables control of the entire plant process – all in a single device.

Webcode:  
web150595

Online information  
at [www.pilz.com](http://www.pilz.com)

- ▶ Soft PLC in accordance with EN/IEC-61131-3 standard
- ▶ CODESYS Runtime and TargetVisu preinstalled
- ▶ High-resolution capacitive TFT displays (7" and 12.1")
- ▶ Display sizes from 7", 12.1" and 15"
- ▶ PMI 6 Assistant

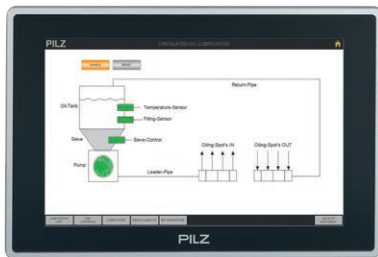

**PMIprimo – motion control panels  
with PLC, motion and CNC functionality**

Control systems PMI 6 primo have PLC, motion and CNC functionality for your automation tasks. Up to 32 axes can be linked flexibly to form a kind of electronic main shaft.

Webcode:  
web150595

Online information  
at [www.pilz.com](http://www.pilz.com)

- ▶ Motion control: dynamic curve calculation and CNC
- ▶ “Flying saw”, “cross cutter” or “cam disc functions”
- ▶ Soft PLC in accordance with EN/IEC-61131-3 standard
- ▶ CODESYS Runtime & TargetVisu preinstalled
- ▶ High-resolution capacitive TFT displays (7" and 12.1")
- ▶ Display sizes from 7", 12.1" and 15"
- ▶ PMI 6 Assistant



## ▶ Operator terminals PMI®

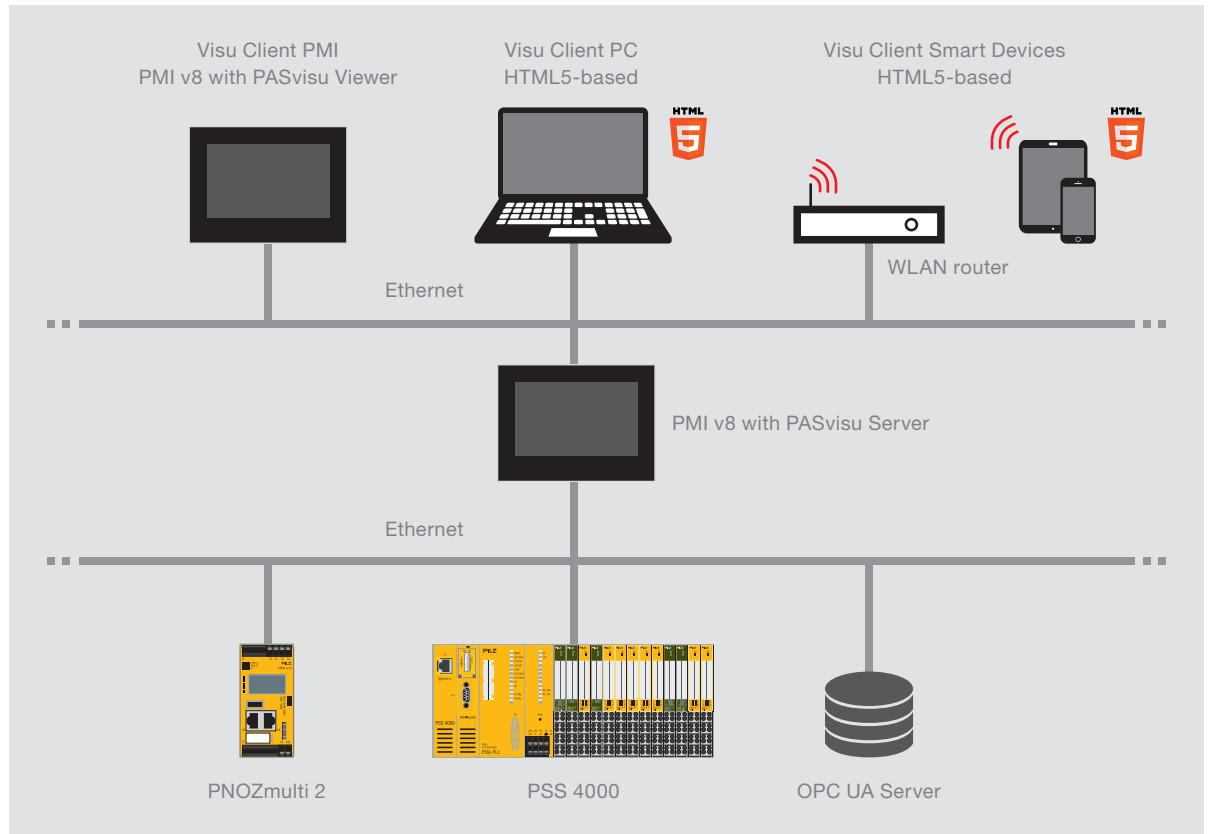

### Diagnostics made easy – with PVIS/PSS 4000

#### Diagnostics based on OPC/OPC UA server

Reliable and easy diagnostics are a prerequisite for enabling plant and machinery to manufacture efficiently, cost effectively and without interruption. With PVIS/ PSS 4000 Diagnostics, Pilz has developed a universal diagnostic solution for the entire range, from small machines to large plants.

The PVIS OPC tools are based on an OPC server. The extended diagnostics of the PVIS/PSS 4000 Diagnostics are therefore available to you, based on standard software interfaces. The PVIS OPC tools can be integrated into almost any environment. You thus receive an ideal solution for your applications with Pilz products!

- ▶ Saves time when troubleshooting and rectifying faults – the machine can be restarted quickly
- ▶ Using the plain text messages, machine operators immediately know which fault has occurred.
- ▶ Active support for the operator in rectifying the fault with step-by-step instructions
- ▶ PVIS/PSS 4000 Diagnostics names the person responsible for rectifying the fault – e.g. a maintenance engineer
- ▶ Less time between machine standstill and starting up again

Webcode:  
web150398

Online information  
at [www.pilz.com](http://www.pilz.com)

### Your benefits at a glance

- ▶ Reduced downtimes and increased cost effectiveness of your system
- ▶ Flexible complete solution for visualization of the automation system PSS 4000, SafetyNET p, Pilz Motion Control (PMC) and PNOZmulti
- ▶ Wide range of application options due to numerous display sizes and feature options
- ▶ Sophisticated diagnostic and visualization concept with the software PASvisu and PVIS/PAS 4000 Diagnostics
- ▶ Resistant to vibration, dust and splashing water (front: IP65)
- ▶ Fast data transfer thanks to Ethernet interface
- ▶ Design, development and manufacture – Made in Germany

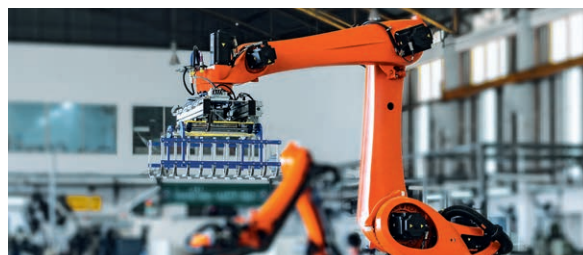
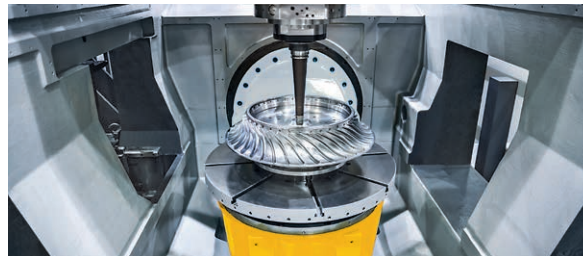

## ► Technical details – operator terminals PMI®

### Operator terminals PMIvisu



PMI v812

Type	Features	Certification	Order number
<b>PMI v704e</b>	<ul style="list-style-type: none"> <li>▶ 4.3" TFT touchscreen</li> <li>▶ Resolution 480 x 272</li> <li>▶ Linux</li> <li>▶ 1 x USB</li> </ul>	CE, cULus Listed, EAC (Eurasian)	266 704
<b>PMI v707e</b>	<ul style="list-style-type: none"> <li>▶ 7" TFT touchscreen</li> <li>▶ Resolution 800 x 480</li> <li>▶ Linux</li> <li>▶ 1 x USB</li> </ul>	CE, cULus Listed, EAC (Eurasian)	266 707
<b>PMI v807</b>	<ul style="list-style-type: none"> <li>▶ 7" TFT touchscreen</li> <li>▶ Resolution 840 x 480</li> <li>▶ Windows 10 IoT</li> <li>▶ 2 x GbE</li> <li>▶ 1 x HDMI</li> <li>▶ 3 x USB</li> </ul>	CE, cULus Listed, EAC (Eurasian)	266 807
<b>PMI v812</b>	<ul style="list-style-type: none"> <li>▶ 12.1" TFT touchscreen</li> <li>▶ Resolution 1 280 x 800</li> <li>▶ Windows 10 IoT</li> <li>▶ 2 x GbE</li> <li>▶ 1 x HDMI</li> <li>▶ 3 x USB</li> </ul>	CE, cULus Listed, EAC (Eurasian)	266 812
<b>PMI 707 Mounting Kit</b>	PMI 707 mounting kit	-	266 100
<b>PMI 704 Holding frame</b>	PMI 704 press-on frame for panel mounting	-	266 101
<b>PMI 707 Holding frame</b>	PMI 707 press-on frame for panel mounting	-	266 102
<b>DIN rail adapter TSH 35</b>	DIN top-hat rail adapter TSH 35	-	266 103
<b>PMI 704 Mounting Kit</b>	PMI 704 mounting kit	-	266 104

Operator terminals PMIcontrol



PMI 607 Control

Type	Features	Certification	Order number
<b>PMI 607 Control</b>	<ul style="list-style-type: none"> <li>▶ 7" TFT touchscreen</li> <li>▶ Resolution 800 x 480</li> <li>▶ Windows Embedded Compact 7</li> <li>▶ 1 x Ethernet</li> <li>▶ 1 x RS232</li> <li>▶ 2 x USB</li> </ul>	CE, cULus Listed, EAC (Eurasian)	265 607
<b>PMI 612 Control</b>	<ul style="list-style-type: none"> <li>▶ 12.1" TFT touchscreen</li> <li>▶ Resolution 1 280 x 800</li> <li>▶ Windows Embedded CE 6.0</li> <li>▶ 1 x Ethernet</li> <li>▶ 1 x RS232</li> <li>▶ 2 x USB</li> </ul>	CE, cULus Listed, EAC (Eurasian)	265 612
<b>PMI 638 Control</b>	<ul style="list-style-type: none"> <li>▶ 15" TFT touchscreen</li> <li>▶ Resolution 1 024 x 768</li> <li>▶ Windows Embedded CE 6.0</li> <li>▶ 1 x Ethernet</li> <li>▶ 1 x RS232</li> <li>▶ 2 x USB</li> </ul>	CE, cULus Listed, EAC (Eurasian)	264 638

Operator terminals PMIprimo



PMI 612 Primo

Type	Features	Certification	Order number
<b>PMI 607 primo</b>	<ul style="list-style-type: none"> <li>▶ 7" TFT touchscreen</li> <li>▶ Resolution 800 x 480</li> <li>▶ Windows Embedded Compact 7</li> <li>▶ 1 x Ethernet</li> <li>▶ 1 x RS232</li> <li>▶ 2 x USB</li> </ul>	CE, cULus Listed, EAC (Eurasian)	265 608
<b>PMI 612 Primo</b>	<ul style="list-style-type: none"> <li>▶ 12.1" TFT touchscreen</li> <li>▶ Resolution 1 280 x 800</li> <li>▶ Windows Embedded CE 6.0</li> <li>▶ 1 x Ethernet</li> <li>▶ 1 x RS232</li> <li>▶ 2 x USB</li> </ul>	CE, cULus Listed, EAC (Eurasian)	265 612
<b>PMI 638 Primo</b>	<ul style="list-style-type: none"> <li>▶ 15" TFT touchscreen</li> <li>▶ Resolution 1 024 x 768</li> <li>▶ Windows Embedded CE 6.0</li> <li>▶ 1 x Ethernet</li> <li>▶ 1 x RS232</li> <li>▶ 2 x USB</li> </ul>	CE, cULus Listed, EAC (Eurasian)	264 638

## ► The web-based visualization software PASvisu – an

Your automation projects can be managed using the web-based visualization software PASvisu for simple configuration and optimum visualization. So you can achieve a convenient, comprehensive overview of your plant locally and via remote access! PASvisu displays your automation projects in a way that's visually attractive thanks to the most diverse range of style sheets.



### Perfectly tailored to the visualization panels PMIvisu

Your plant visualization is optimally displayed on the Pilz Human Machine Interface PMIvisu. The software is already preinstalled and licensed on the visualization panels PMI v7e and PMI v8. With this combination, you can visualize and diagnose all functions of the small controllers PNOZmulti via direct connection.

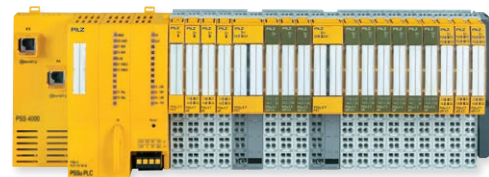

### Connecting to the automation system PSS 4000

The web-based visualization software PASvisu is perfectly matched to the automation system PSS 4000 from Pilz. This means its control software PAS4000 can easily be linked to the visualization software PASvisu. The result is a perfect blend of control system and visualization – for all the phases of the machine's lifecycle.

# overview of your entire automation!



## Connection of the configurable safe small controller PNOZmulti to the visualization software PASvisu

You can now directly link the configurable safe small controllers PNOZmulti directly to the visualization software PASvisu. As a result, the full range of functions of the software is available to you, incl. diagnostic option. Benefit from short downtimes thanks to fast restart!



## PASvisu is open for all systems

You can thus easily link any controllers that you are currently using to the visualization software via an OPC UA server connection and transfer all variables of the controller. With PASvisu Version 1.8. and later, data from several sources can be visualized in one PASvisu project. You can thus display data from different controllers or automation systems, for example from PNOZmulti 2 and PSS 4000 projects, in a single visualization project. Including diagnostic option.

### Your benefits at a glance

- ▶ Accelerated projects: from engineering through to runtime to maintenance
- ▶ Link between control and PASvisu projects enables shorter project times
- ▶ Faster engineering, as variables do not need to be entered and assigned manually
- ▶ Flexible use on a multitude of end devices – thanks to platform independence
- ▶ Language switching: create, export and import languages
- ▶ Data logging: logging of variables and export via CSV file
- ▶ Advanced trend tile: display of logged trends, targeted filtering by elapsed time and addition of dynamic trend lines
- ▶ Integrated recipe manager for convenient definition of the data sets for your machine visualization

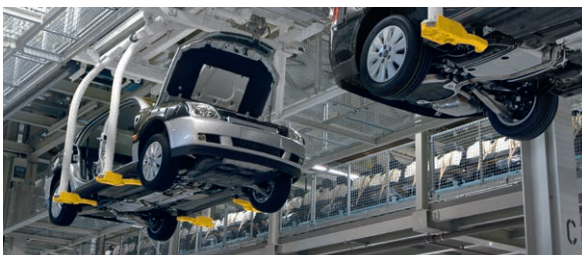

## ► Services: Consulting, engineering and training

As a solution supplier, Pilz can help you in the global application of optimum safety strategies that comply with specifications. Our services ensure the highest safety for man and machine worldwide.

### Pilz Services for Safety and Automation



#### Machinery safety

Safety through the whole machine lifecycle

- Risk Assessment
- Safety Concept
- Safety Design
- System Implementation
- Validation

Safe machinery at any stage



#### International compliance

Conformity with international standards and regulations

- CE Marking
- USA
- NR-12

Compliant machines worldwide



#### Workplace safety

Absolute safety when operating machines

- Plant Assessment
- Lockout Tagout System
- Inspection of Safeguarding Devices

The maximum possible safety for man and machine



#### Training

International qualification program and certified courses

Enhancement of professional development





### Training

Pilz supports you with a comprehensive range of training courses on all topics of machinery safety and automation.



### Machinery safety

#### Risk Assessment

We review your machinery in accordance with the applicable standards and directives and assess the existing hazards.

#### Safety Concept

We develop detailed technical solutions for the safety of your plant and machinery through mechanical, electronic and organizational measures.

#### Safety Design

The aim of the safety design is to reduce or eliminate danger points through detailed planning of the necessary protective measures.

#### System Implementation

The results of the risk analysis and safety design are implemented to suit the particular requirements through selected safety measures.

#### Validation

In the validation, the risk assessment and safety concept are mirrored and inspected by competent, specialist staff.

We can also perform collision measurement for human-robot applications in accordance with the limit values from ISO/TS 15066.



### International compliance

#### CE Marking

We control all activities and processes for the necessary conformity assessment procedure, including the technical documentation that is required.

#### USA

With us you'll receive all the necessary documents that are required to have your machine certified through local authorities to achieve US compliance.

#### NR-12

As a complete supplier we can provide support from risk assessment to validation, technical documentation at the manufacturer's and final acceptance at the operator's in Brazil.



### Workplace safety

#### Plant Assessment

We will prepare an overview of your entire plant in the shortest possible time. With an on-site inspection we will expose risks and calculate the cost of optimizing your safeguards.

#### Lockout Tagout System

Our customized lockout tagout (LoTo) measures guarantee that staff can safely control potentially hazardous energies during maintenance and repair.

#### Inspection of Safeguarding Devices

With our independent, ISO 17020-compliant inspection body, which is accredited by the German Accreditation Body (DAkkS), we can guarantee objectivity and high availability of your machines.



Pilz GmbH & Co. KG, Ostfildern, operates an inspection body for plant and machinery, accredited by DAkkS.

# Index

- ▶ **0-9**
  - 2-relay technology \_\_\_\_\_ 34
- ▶ **A**
  - Absolute encoder \_\_\_\_\_ 125, 133
  - Access permission \_\_\_\_\_ 80
  - AC/DC supplies \_\_\_\_\_ 13, 17
  - ActiveX Control UA \_\_\_\_\_ 97
  - Adapter \_\_\_\_\_ 95, 98, 99, 101, 102
  - Analog inputs and outputs \_\_\_\_\_ 122
  - Analog output \_\_\_\_\_ 13, 17, 24, 25, 33, 154, 161
  - Analysis unit \_\_\_\_\_ 100, 102
  - AND/OR operation \_\_\_\_\_ 45
  - Automation \_\_\_\_\_ 3, 5, 104, 106, 108, 110, 134
  - Automation system
    - PSS 4000 \_\_\_\_\_ 106, 108, 110, 111, 116, 130, 179, 182
- ▶ **B**
  - Backplane/module rack \_\_\_\_\_ 136
  - BiSS \_\_\_\_\_ 151, 162
  - Block switching module \_\_\_\_\_ 119
  - Brake control, safe \_\_\_\_\_ 27
  - Burner controls \_\_\_\_\_ 22, 79, 87
- ▶ **C**
  - Cable \_\_\_\_\_ 87, 98, 99, 102, 127, 129
  - Cable cars \_\_\_\_\_ 53
  - Cable navigator \_\_\_\_\_ 102
  - CANopen \_\_\_\_\_ 70, 150, 151, 162
  - CC-Link \_\_\_\_\_ 70
  - CIP Safety \_\_\_\_\_ 107, 134, 137
  - CODESYS runtime \_\_\_\_\_ 177
  - Communication networks \_\_\_\_\_ 70, 110
  - Configurable safe
    - small controllers \_\_\_\_\_ 64, 66, 68, 70, 72, 74, 76, 78, 80, 82, 84
  - Configuration \_\_\_\_\_ 7, 24, 67, 69, 74, 77, 78, 106, 108, 114, 115, 128, 135
  - Contact expansion \_\_\_\_\_ 20, 23, 25, 32, 56
  - Controllers \_\_\_\_\_ 104, 106
  - Controllers and I/O systems \_\_\_\_\_ 106, 116
  - Control panels \_\_\_\_\_ 177
  - Control system \_\_\_\_\_ 150
  - Control technology \_\_\_\_\_ 4, 6, 8
  - Convection-cooled \_\_\_\_\_ 170
  - Counter modules \_\_\_\_\_ 124
  - Current monitoring \_\_\_\_\_ 15
- ▶ **D**
  - Decentralized modules \_\_\_\_\_ 73, 101
  - Diagnostics \_\_\_\_\_ 15, 18, 20, 27, 44, 55, 60, 61, 67, 71, 178
  - Diagnostic solution PVIS \_\_\_\_\_ 68, 71, 96
  - Digital inputs and outputs \_\_\_\_\_ 120, 138
  - DIN EN 61557-8 \_\_\_\_\_ 13, 17
  - DIN ISO 9001 \_\_\_\_\_ 19
  - DIN VDE 0100-710 \_\_\_\_\_ 13
- Direction of rotation \_\_\_\_\_ 17, 24
- Distribution modules \_\_\_\_\_ 119, 136
- Diverse safety contacts \_\_\_\_\_ 22, 31
- Drive Technology \_\_\_\_\_ 144
- ▶ **E**
  - Earth fault monitoring \_\_\_\_\_ 17
  - Economical operation \_\_\_\_\_ 162
  - Electrical safety \_\_\_\_\_ 12
  - Electric gear function \_\_\_\_\_ 158
  - Electromechanical contacts \_\_\_\_\_ 34
  - Electronic modules \_\_\_\_\_ 124
  - Electronic monitoring relays \_\_\_\_\_ 12, 14
  - Emergency stop \_\_\_\_\_ 18, 34, 42, 54, 114
  - EN 81-1/A3 \_\_\_\_\_ 31
  - EN 50156-1 \_\_\_\_\_ 22, 31
  - EN 61800-5-2 \_\_\_\_\_ 24, 76
  - EnDat \_\_\_\_\_ 151, 162
  - EN/IEC 61131-3 \_\_\_\_\_ 110, 177
  - EN/IEC 61508 \_\_\_\_\_ 9
  - EN/IEC 62061 \_\_\_\_\_ 8, 9, 24, 27, 89, 101
  - EN ISO 12100 \_\_\_\_\_ 8
  - EN ISO 13849-1 \_\_\_\_\_ 8, 24, 25, 26, 27, 89, 101
  - EN ISO 13849-2 \_\_\_\_\_ 8
  - E-STOP relays \_\_\_\_\_ 18
  - EtherCAT \_\_\_\_\_ 70, 110, 129, 150, 151, 162
  - Ethernet \_\_\_\_\_ 63
  - EtherNet/IP \_\_\_\_\_ 63, 70, 107, 110, 134, 137
  - Ethernet TCP/IP \_\_\_\_\_ 70, 117
- ▶ **F**
  - Feedback \_\_\_\_\_ 151
  - Fieldbus \_\_\_\_\_ 75, 112, 161
  - Fieldbus modules \_\_\_\_\_ 60, 70, 95
  - Filling \_\_\_\_\_ 146
  - Fill level \_\_\_\_\_ 12, 75
  - Firewall SecurityBridge \_\_\_\_\_ 110, 113, 128
  - Flow wrapping machine \_\_\_\_\_ 147
  - Flying saw \_\_\_\_\_ 146
  - Forced air-cooled \_\_\_\_\_ 172
  - Furnaces \_\_\_\_\_ 22, 79
- ▶ **G**
  - Gateways \_\_\_\_\_ 129
  - General failsafe control blocks \_\_\_\_\_ 132
- ▶ **H**
  - Hardware-related blocks \_\_\_\_\_ 133
  - Head modules \_\_\_\_\_ 106, 116, 136
  - HIPERFACE DSL \_\_\_\_\_ 151, 162, 166
  - Holding brakes \_\_\_\_\_ 26
- ▶ **I**
  - IEC 60364-7-710 \_\_\_\_\_ 13
  - IIoT Gateway \_\_\_\_\_ 129
  - Improved mechanical design \_\_\_\_\_ 135
  - Increased environmental requirements \_\_\_\_\_ 117, 119, 121, 123, 125, 127
- Incremental encoder \_\_\_\_\_ 151, 162
- Independent periphery test \_\_\_\_\_ 114
- Industrie 4.0 \_\_\_\_\_ 60, 71, 108
- Input and output modules \_\_\_\_\_ 106, 107
- Inputs and outputs \_\_\_\_\_ 69, 72, 151
- Instruction list \_\_\_\_\_ 110, 117, 130
- Insulation fault \_\_\_\_\_ 14
- Insulation monitoring \_\_\_\_\_ 17
- Insulation resistance \_\_\_\_\_ 13
- IO-Link devices \_\_\_\_\_ 135
- I/O systems \_\_\_\_\_ 104, 106
- IP20 \_\_\_\_\_ 61, 63, 108, 152, 154, 161, 164
- IP67 \_\_\_\_\_ 61, 63, 73, 100, 108, 109, 117
- IT networks \_\_\_\_\_ 13, 17
- ▶ **L**
  - Labelling \_\_\_\_\_ 147
  - Ladder Diagram \_\_\_\_\_ 110, 117
  - Light beam devices \_\_\_\_\_ 18, 34, 42
  - Link modules \_\_\_\_\_ 67, 73, 93
  - Logic function operations \_\_\_\_\_ 44
- ▶ **M**
  - Machine control \_\_\_\_\_ 67
  - Machinery Directive \_\_\_\_\_ 8, 9, 24
  - Managed Switches \_\_\_\_\_ 128
  - Modbus TCP \_\_\_\_\_ 70, 110
  - modular safety gate system \_\_\_\_\_ 84
  - Modular structure \_\_\_\_\_ 18, 60, 73
  - Module program (mIQ) \_\_\_\_\_ 75, 76, 77, 78, 87, 89, 91
  - Motion control systems \_\_\_\_\_ 148, 156
  - Motor feedback \_\_\_\_\_ 25
  - Motors \_\_\_\_\_ 166
  - Multi-master design \_\_\_\_\_ 111
  - Multi-master principle \_\_\_\_\_ 108
  - Muting \_\_\_\_\_ 34, 41
- ▶ **N**
  - Networks \_\_\_\_\_ 112
  - Non-wearing \_\_\_\_\_ 18, 23, 44
- ▶ **O**
  - OPC UA Server \_\_\_\_\_ 71, 97
  - Operating modes \_\_\_\_\_ 18, 20, 22, 51, 133
  - Operating mode selection \_\_\_\_\_ 80
  - Operating mode selector switch \_\_\_\_\_ 132
  - Operating modes, selectable \_\_\_\_\_ 20
  - Operator terminals \_\_\_\_\_ 71, 153, 174, 176, 178, 180
  - Optimized address management \_\_\_\_\_ 115
  - Overcurrent \_\_\_\_\_ 14
  - Overexcitation \_\_\_\_\_ 26
  - Overload \_\_\_\_\_ 14
  - Overload and underload monitoring \_\_\_\_\_ 13
  - Overtemperature \_\_\_\_\_ 14
  - Overvoltage \_\_\_\_\_ 14
- ▶ **P**
  - Package filtering \_\_\_\_\_ 113

- PAS4000 \_\_\_\_\_ 108, 110, 130, 132, 182  
 PASconfig \_\_\_\_\_ 135  
 PAS IL/LD/STL \_\_\_\_\_ 110, 117, 130  
 PASvisu \_\_\_\_\_ 66, 130  
 PDP67 \_\_\_\_\_ 66, 73, 100, 102  
 Periphery \_\_\_\_\_ 114  
 Phase failure monitoring \_\_\_\_\_ 17  
 Phase sequence evaluation \_\_\_\_\_ 17  
 Phase sequence monitoring \_\_\_\_\_ 17  
 PIT \_\_\_\_\_ 66  
 PITreader \_\_\_\_\_ 80  
 PLIDdys, safe line inspection device \_\_\_\_\_ 52  
 PMC \_\_\_\_\_ 66, 144  
 PMIcontrol \_\_\_\_\_ 177, 181  
 PMIprimo \_\_\_\_\_ 177, 181  
 PMIvisu \_\_\_\_\_ 66, 176, 180, 182  
 PMIvisu eco \_\_\_\_\_ 176  
 PNOZcompact \_\_\_\_\_ 18, 42  
 PNOZelog \_\_\_\_\_ 18, 44  
 PNOZmulti \_\_\_\_\_ 66, 68, 70  
 PNOZmulti 2 \_\_\_\_\_ 72, 74, 76, 78, 79, 80, 82, 84  
 PNOZmulti Configurator \_\_\_\_\_ 66, 67, 68, 69, 70, 71, 74, 75, 76, 78, 79, 80, 96  
 PNOZpower \_\_\_\_\_ 18, 54  
 PNOZsigma \_\_\_\_\_ 18, 20, 22, 24, 26  
 PNOZ X \_\_\_\_\_ 18, 34  
 Position \_\_\_\_\_ 24, 33, 132  
 Position monitoring \_\_\_\_\_ 72  
 POWERLINK \_\_\_\_\_ 70  
 Press control blocks \_\_\_\_\_ 133  
 Presses \_\_\_\_\_ 77, 78, 133, 146  
 Pressure sensitive mats \_\_\_\_\_ 18  
 PROFIBUS-DP \_\_\_\_\_ 63, 70  
 PROFINET \_\_\_\_\_ 63, 70, 107, 110, 115, 134, 135, 137  
 PROFIsafe \_\_\_\_\_ 107, 115, 134, 135, 137  
 Program editor PASmulti \_\_\_\_\_ 110, 130  
 Protection zone monitoring \_\_\_\_\_ 82  
 Proximity switch \_\_\_\_\_ 25  
 PSS67 PLC \_\_\_\_\_ 109  
 PSSuniversal \_\_\_\_\_ 104, 105, 106, 114, 115  
 PSSuniversal 2 \_\_\_\_\_ 107, 134, 135  
 PSSuniversal Assistant \_\_\_\_\_ 115, 130  
 PSSuniversal PLC \_\_\_\_\_ 109  
 PSSuniversal Startup Software \_\_\_\_\_ 130  
 Push-in technology \_\_\_\_\_ 18, 20, 43  
 PVIS OPC Tools \_\_\_\_\_ 71, 178
- **R**  
 Radar technology \_\_\_\_\_ 82  
 Rail transport \_\_\_\_\_ 111  
 Railway requirements \_\_\_\_\_ 117, 119, 121, 123, 125  
 Real-time Ethernet SafetyNET p \_\_\_\_\_ 74, 110  
 Remote access \_\_\_\_\_ 71  
 Remote I/O system \_\_\_\_\_ 107, 114, 134  
 Residual voltage \_\_\_\_\_ 14  
 Resolver \_\_\_\_\_ 151, 162
- RS232 \_\_\_\_\_ 125, 152, 181  
 RS485 \_\_\_\_\_ 125
- **S**  
 Safe block switching \_\_\_\_\_ 114  
 Safe brake control (SBC) \_\_\_\_\_ 165  
 Safe brake test (SBT) \_\_\_\_\_ 165  
 Safe communication \_\_\_\_\_ 74  
 Safe direction (SDI) \_\_\_\_\_ 165  
 Safe drive-based motion control system \_\_\_\_\_ 154  
 Safely limited increment (SLI) \_\_\_\_\_ 165  
 Safely limited position (SLP) \_\_\_\_\_ 165  
 Safely limited speed (SLS) \_\_\_\_\_ 165  
 Safe motion \_\_\_\_\_ 162  
 Safe networking \_\_\_\_\_ 163  
 Safe operating stop (SOS) \_\_\_\_\_ 165  
 Safe press applications \_\_\_\_\_ 78  
 Safe speed range (SSR) \_\_\_\_\_ 165  
 Safe stop 1 (SS1) \_\_\_\_\_ 165  
 Safe stop 2 (SS2) \_\_\_\_\_ 165  
 Safe torque off (STO) \_\_\_\_\_ 165  
 Safety brakes \_\_\_\_\_ 26, 27  
 Safety card \_\_\_\_\_ 162, 164  
 Safety contacts \_\_\_\_\_ 18, 23, 54  
 Safety Device Diagnostics \_\_\_\_\_ 60  
 Safety, electrical \_\_\_\_\_ 10  
 Safety, functional \_\_\_\_\_ 10  
 Safety functions \_\_\_\_\_ 18, 20, 24, 44, 66, 72, 150, 162  
 Safety gates \_\_\_\_\_ 18, 34, 42, 54  
 SafetyNET p \_\_\_\_\_ 70, 74, 110  
 Safety relays \_\_\_\_\_ 18, 20, 22, 24, 26, 34, 42, 44, 54, 100  
 Safety technology \_\_\_\_\_ 8, 18, 20  
 Safety valves \_\_\_\_\_ 22  
 Scalability \_\_\_\_\_ 19  
 Sensorless \_\_\_\_\_ 151, 162  
 Servo amplifiers \_\_\_\_\_ 158, 160  
 Servo motors \_\_\_\_\_ 166, 169  
 Servo press \_\_\_\_\_ 146  
 Set-up mode \_\_\_\_\_ 24, 78, 146  
 Shear pin breakage \_\_\_\_\_ 24, 78, 91  
 Single stroke \_\_\_\_\_ 78  
 Soft PLC \_\_\_\_\_ 176, 177  
 Software \_\_\_\_\_ 66, 68, 70, 72, 79, 96, 106, 108, 110, 112, 130, 132, 135, 182  
 Software blocks \_\_\_\_\_ 66, 67, 75, 78, 132  
 Speed \_\_\_\_\_ 24, 25, 33, 34, 76  
 Speed control \_\_\_\_\_ 158  
 Speed monitor \_\_\_\_\_ 24, 28, 99  
 Speed monitoring \_\_\_\_\_ 32  
 Speed range \_\_\_\_\_ 24, 33  
 Standardization \_\_\_\_\_ 42  
 Standstill \_\_\_\_\_ 24, 33, 132  
 Standstill monitor \_\_\_\_\_ 28, 99  
 Standstill monitoring \_\_\_\_\_ 14, 34, 41  
 Startup Tool \_\_\_\_\_ 115  
 Stripping tool \_\_\_\_\_ 129
- Structured text \_\_\_\_\_ 110, 117  
 Supply modules \_\_\_\_\_ 119, 136  
 Switchgear \_\_\_\_\_ 10
- **T**  
 TargetVisu \_\_\_\_\_ 177  
 TCI \_\_\_\_\_ 115  
 Temperature fluctuations \_\_\_\_\_ 111  
 Temperature monitoring \_\_\_\_\_ 15, 17  
 Timer functions \_\_\_\_\_ 20, 31  
 Times, selectable \_\_\_\_\_ 20  
 Tool support \_\_\_\_\_ 115  
 Torque control \_\_\_\_\_ 158  
 True power conversion \_\_\_\_\_ 13  
 True power monitoring \_\_\_\_\_ 12, 14, 17  
 Two-hand control \_\_\_\_\_ 18, 34, 86
- **U**  
 Unearthed AC/DC systems \_\_\_\_\_ 13  
 Universal power supply \_\_\_\_\_ 18, 19, 34  
 Unmanaged switches \_\_\_\_\_ 128  
 USB port \_\_\_\_\_ 87, 115, 130, 157  
 User management \_\_\_\_\_ 113
- **V**  
 Visualization \_\_\_\_\_ 26, 71, 108, 130  
 Visualization panels \_\_\_\_\_ 176  
 Visualization software PASvisu, web-based \_\_\_\_\_ 68, 110, 130, 176, 182  
 Voltage-free contacts \_\_\_\_\_ 34  
 Voltage monitoring \_\_\_\_\_ 15
- **W**  
 Wind turbines \_\_\_\_\_ 53  
 Wraparound \_\_\_\_\_ 147

## ▶ Contact

### AT

Pilz Ges.m.b.H.  
Sichere Automation  
Modecenterstraße 14  
1030 Wien  
Austria  
Telephone: +43 1 7986263-0  
Telefax: +43 1 7986264  
E-Mail: [pilz@pilz.at](mailto:pilz@pilz.at)  
Internet: [www.pilz.at](http://www.pilz.at)

### AU

Pilz Australia  
Safe Automation  
Unit 1, 12-14 Miles Street  
Mulgrave  
Victoria 3170  
Australia  
Telephone: +61 3 95600621  
Telefax: +61 3 95749035  
E-Mail: [safety@pilz.com.au](mailto:safety@pilz.com.au)  
Internet: [www.pilz.com.au](http://www.pilz.com.au)

### BE, LU

Pilz Belgium  
Safe Automation  
Poortakkerstraat 37/0201  
9051 Sint-Denijs-Westrem  
Belgium  
Telephone: +32 9 3217570  
Telefax: +32 9 3217571  
E-Mail: [info@pilz.be](mailto:info@pilz.be)  
Internet: [www.pilz.be](http://www.pilz.be)

### BR

Pilz do Brasil  
R. Joaquim Pupo, 443  
Distrito Industrial João Narezzi  
Indaiatuba – SP  
13347-437  
Brazil  
Telephone: +55 11 4126-7290  
Telefax: +55 11 4942-7002  
E-Mail: [pilz@pilz.com.br](mailto:pilz@pilz.com.br)  
Internet: [www.pilz.com.br](http://www.pilz.com.br)

### CA

Pilz Automation Safety Canada L.P.  
6695 Millcreek Drive  
Mississauga, ON  
L5N 5M4  
Canada  
Telephone: +1 905 821 7459  
Telefax: +1 905 821 7459  
E-Mail: [info@pilz.ca](mailto:info@pilz.ca)  
Internet: [www.pilz.ca](http://www.pilz.ca)

### CH

Pilz Industrieelektronik GmbH  
Gewerbepark Hintermättli  
5506 Mägenwil  
Switzerland  
Telephone: +41 62 88979-30  
Telefax: +41 62 88979-40  
E-Mail: [pilz@pilz.ch](mailto:pilz@pilz.ch)  
Internet: [www.pilz.ch](http://www.pilz.ch)

### CN

Pilz Industrial Automation  
Trading (Shanghai) Co., Ltd.  
Rm. 1702-1704  
Yongda International Tower  
No. 2277 Long Yang Road  
Shanghai 201204  
China  
Telephone: +86 21 60880878  
Telefax: +86 21 60880870  
E-Mail: [sales@pilz.com.cn](mailto:sales@pilz.com.cn)  
Internet: [www.pilz.com.cn](http://www.pilz.com.cn)

### CZ

Pilz Czech s.r.o  
Safe Automation  
Zelený pruh 95/97  
140 00 Praha 4  
Czech Republic  
Telephone: +420 222 135353  
Telefax: +420 296 374788  
E-Mail: [info@pilz.cz](mailto:info@pilz.cz)  
Internet: [www.pilz.cz](http://www.pilz.cz)

### DE

Pilz GmbH & Co. KG  
Felix-Wankel-Straße 2  
73760 Ostfildern  
Germany  
Telephone: +49 711 3409-0  
Telefax: +49 711 3409-133  
E-Mail: [info@pilz.de](mailto:info@pilz.de)  
Internet: [www.pilz.de](http://www.pilz.de)

### DK

Pilz Skandinavien K/S  
Safe Automation  
Ellegaardvej 25 D  
6400 Sonderborg  
Denmark  
Telephone: +45 74436332  
Telefax: +45 74436342  
E-Mail: [pilz@pilz.dk](mailto:pilz@pilz.dk)  
Internet: [www.pilz.dk](http://www.pilz.dk)

### ES

Pilz Industrieelektronik S.L.  
Safe Automation  
Camí Ral, 130  
Polígono Industrial Palou Nord  
08401 Granollers  
Spain  
Telephone: +34 938497433  
Telefax: +34 938497544  
E-Mail: [pilz@pilz.es](mailto:pilz@pilz.es)  
Internet: [www.pilz.es](http://www.pilz.es)

### FI

Pilz Skandinavien K/S  
Safe Automation  
Elannontie 5  
01510 Vantaa  
Finland  
Telephone: +358 10 3224030  
Telefax: +358 9 27093709  
E-Mail: [pilz.fi@pilz.dk](mailto:pilz.fi@pilz.dk)  
Internet: [www.pilz.fi](http://www.pilz.fi)

### FR

Pilz France Electronic  
21 Rue de la Haye  
Espace Européen de l'Entreprise  
Bâtiment ALTIS  
67300 Schiltigheim  
France  
Telephone Sales Department:  
+33 3 88104001  
Telephone Order Processing:  
+33 3 88104002  
Telefax: +33 3 88108000  
E-Mail: [siege@pilz-france.fr](mailto:siege@pilz-france.fr)  
Internet: [www.pilz.fr](http://www.pilz.fr)

### GB

Pilz Automation Ltd  
Pilz House  
Little Colliers Field  
Corby, Northants  
NN18 8TJ  
United Kingdom  
Telephone: +44 1536 460766  
Telefax: +44 1536 460866  
E-Mail: [sales@pilz.co.uk](mailto:sales@pilz.co.uk)  
Internet: [www.pilz.co.uk](http://www.pilz.co.uk)

### ID

Pilz South East Asia Pte. Ltd.  
25 International Business Park  
#04-56 German Centre  
Singapore 609916  
Singapore  
Telephone: +65 6839 292-0  
Telefax: +65 6839 292-1  
E-Mail: [sales@pilz.sg](mailto:sales@pilz.sg)  
Internet: [www.pilz.sg](http://www.pilz.sg)

### IE

Pilz Ireland Industrial Automation  
Cork Business and Technology Park  
Model Farm Road  
Cork  
Ireland  
Telephone: +353 21 4346535  
Telefax: +353 21 4804994  
E-Mail: [sales@pilz.ie](mailto:sales@pilz.ie)  
Internet: [www.pilz.ie](http://www.pilz.ie)

### IN

Pilz India Pvt. Ltd  
6th Floor, 'Cybernex'  
Shankar Sheth Road, Swargate  
Pune 411042  
India  
Telephone: +91 20 49221100/-1/-2  
Telefax: +91 20 49221103  
E-Mail: [info@pilz.in](mailto:info@pilz.in)  
Internet: [www.pilz.in](http://www.pilz.in)

### IT, MT

Pilz Italia S.r.l.  
Automazione sicura  
Via Gran Sasso n. 1  
20823 Lentate sul Seveso (MB)  
Italy  
Telephone: +39 0362 1826711  
Telefax: +39 0362 1826755  
E-Mail: [info@pilz.it](mailto:info@pilz.it)  
Internet: [www.pilz.it](http://www.pilz.it)

### JP

Pilz Japan Co., Ltd.  
Safe Automation  
Ichigo Shin-Yokohama Bldg. 4F  
3-17-5 Shin-Yokohama  
Kohoku-ku  
222-0033 Yokohama  
Japan  
Telephone: +81 45 471-2281  
Telefax: +81 45 471-2283  
E-Mail: [pilz@pilz.co.jp](mailto:pilz@pilz.co.jp)  
Internet: [www.pilz.jp](http://www.pilz.jp)

#### Headquarters:

Pilz GmbH & Co. KG, Felix-Wankel-Straße 2, 73760 Ostfildern, Germany  
Telephone: +49 711 3409-0, Telefax: +49 711 3409-133, E-Mail: [info@pilz.de](mailto:info@pilz.de), Internet: [www.pilz.com](http://www.pilz.com)

**KH**

Pilz South East Asia Pte. Ltd.  
25 International Business Park  
#04-56 German Centre  
Singapore 609916  
Singapore  
Telephone: +65 6839 292-0  
Telefax: +65 6839 292-1  
E-Mail: sales@pilz.sg  
Internet: www.pilz.sg

**KR**

Pilz Korea Ltd.  
Safe Automation  
4FL, Elentec bldg.,  
17 Pangyoro-228 Bundang-gu  
Seongnam-si  
Gyunggi-do  
South Korea 13487  
Telephone: +82 31 778 3300  
Telefax: +82 31 778 3399  
E-Mail: info@pilzkorea.co.kr  
Internet: www.pilz.co.kr

**LA**

Pilz South East Asia Pte. Ltd.  
25 International Business Park  
#04-56 German Centre  
Singapore 609916  
Singapore  
Telephone: +65 6839 292-0  
Telefax: +65 6839 292-1  
E-Mail: sales@pilz.sg  
Internet: www.pilz.sg

**MX**

Pilz de México, S. de R.L. de C.V.  
Automatización Segura  
Convento de Actopan 36  
Jardines de Santa Mónica  
Tlalnepantla, Méx. 54050  
Mexico  
Telephone: +52 55 5572 1300  
Telefax: +52 55 5572 1300  
E-Mail: info@pilz.com.mx  
Internet: www.pilz.mx

**MY**

Pilz South East Asia Pte. Ltd.  
25 International Business Park  
#04-56 German Centre  
Singapore 609916  
Singapore  
Telephone: +65 6839 292-0  
Telefax: +65 6839 292-1  
E-Mail: sales@pilz.sg  
Internet: www.pilz.sg

**NL**

Pilz Nederland  
Veilige automatisering  
Havenweg 22  
4131 NM Vianen  
Netherlands  
Telephone: +31 347 320477  
Telefax: +31 347 320485  
E-Mail: info@pilz.nl  
Internet: www.pilz.nl

**NZ**

Pilz New Zealand  
Safe Automation  
Unit 4, 12 Laidlaw Way  
East Tamaki  
Auckland 2016  
New Zealand  
Telephone: +64 9 6345350  
Telefax: +64 9 6345352  
E-Mail: office@pilz.co.nz  
Internet: www.pilz.co.nz

**PH**

Pilz South East Asia Pte. Ltd.  
25 International Business Park  
#04-56 German Centre  
Singapore 609916  
Singapore  
Telephone: +65 6839 292-0  
Telefax: +65 6839 292-1  
E-Mail: sales@pilz.sg  
Internet: www.pilz.sg

**PL, BY, UA**

Pilz Polska Sp. z o.o.  
Safe Automation  
ul. Ruchliwa 15  
02-182 Warszawa  
Poland  
Telephone: +48 22 8847100  
Telefax: +48 22 8847109  
E-Mail: info@pilz.pl  
Internet: www.pilz.pl

**PT**

Pilz Industrielektronik S.L.  
Edifício Tower Plaza  
Rotunda Eng. Egdar Cardoso  
Nº 23, 5º - Sala E  
4400-676 Vila Nova de Gaia  
Portugal  
Telephone: +351 229407594  
E-Mail: info@pilz.pt  
Internet: www.pilz.pt

**RU**

Pilz RUS OOO  
Ugreshskaya street, 2,  
bldg. 11, office 16 (1st floor)  
115088 Moskau  
Russian Federation  
Telephone: +7 495 665 4993  
E-Mail: pilz@pilzrussia.ru  
Internet: www.pilzrussia.ru

**SE**

Pilz Skandinavien K/S  
Safe Automation  
Smörhålevägen 3  
43442 Kungsbacka  
Sweden  
Telephone: +46 300 13990  
Telefax: +46 300 30740  
E-Mail: pilz.se@pilz.dk  
Internet: www.pilz.se

**SG**

Pilz South East Asia Pte. Ltd.  
25 International Business Park  
#04-56 German Centre  
Singapore 609916  
Singapore  
Telephone: +65 6839 292-0  
Telefax: +65 6839 292-1  
E-Mail: sales@pilz.sg  
Internet: www.pilz.sg

**SK**

Pilz Slovakia s.r.o.  
Štúrova 101  
05921 Svit  
Slovakia  
Telephone: +421 52 7152601  
E-Mail: info@pilzlovakia.sk  
Internet: www.pilzlovakia.sk

**TH**

Pilz South East Asia Pte. Ltd.  
25 International Business Park  
#04-56 German Centre  
Singapore 609916  
Singapore  
Telephone: +65 6839 292-0  
Telefax: +65 6839 292-1  
E-Mail: sales@pilz.sg  
Internet: www.pilz.sg

**TR**

Pilz Emniyet Otomasyon  
Ürünleri ve Hizmetleri Tic. Ltd. Şti.  
Kayışdağı Mahallesi Dudullu Yolu Cad.  
Mecnun Sok. Duru Plaza No:7  
34755 Ataşehir/İstanbul  
Turkey  
Telephone: +90 216 5775550  
Telefax: +90 216 5775549  
E-Mail: info@pilz.com.tr  
Internet: www.pilz.com.tr

**TW**

Pilz Taiwan Ltd.  
10F., No. 36, Sec. 3, Bade Rd.  
Songsshan Dist., Taipei City 105  
Taiwan (R.O.C.)  
Telephone: +886 2 2570 0068  
Telefax: +886 2 2570 0078  
E-Mail: info@pilz.tw  
Internet: www.pilz.tw

**US**

Pilz Automation Safety L.P.  
7150 Commerce Boulevard  
Canton  
Michigan 48187  
USA  
Telephone: +1 734 354 0272  
Telefax: +1 734 354 3355  
E-Mail: info@pilzusa.com  
Internet: www.pilz.us

**VN**

Pilz South East Asia Pte. Ltd.  
25 International Business Park  
#04-56 German Centre  
Singapore 609916  
Singapore  
Telephone: +65 6839 292-0  
Telefax: +65 6839 292-1  
E-Mail: sales@pilz.sg  
Internet: www.pilz.sg





# Support

Technical support is available from Pilz round the clock.

## Americas

### Brazil

+55 11 97569-2804

### Canada

+1 888 315 7459

### Mexico

+52 55 5572 1300

### USA (toll-free)

+1 877-PILZUSA (745-9872)

## Asia

### China

+86 21 60880878-216

### Japan

+81 45 471-2281

### South Korea

+82 31 778 3300

## Australia and Oceania

### Australia

+61 3 95600621

### New Zealand

+64 9 6345350

## Europe

### Austria

+43 1 7986263-0

### Belgium, Luxembourg

+32 9 3217570

### France

+33 3 88104003

### Germany

+49 711 3409-444

### Ireland

+353 21 4804983

### Italy, Malta

+39 0362 1826711

## Scandinavia

+45 74436332

## Spain

+34 938497433

## Switzerland

+41 62 88979-32

## The Netherlands

+31 347 320477

## Turkey

+90 216 5775552

## United Kingdom

+44 1536 462203

## You can reach our international hotline on:

+49 711 3409-222

support@pilz.com

Pilz develops environmentally-friendly products using ecological materials and energy-saving technologies. Offices and production facilities are ecologically designed, environmentally-aware and energy-saving. So Pilz offers sustainability, plus the security of using energy-efficient products and environmentally-friendly solutions.



Presented by:



In many countries we are represented by sales partners. Please refer to our homepage [www.pilz.com](http://www.pilz.com) for further details or contact our headquarters.

Printed on 100 % recycled paper for the good of the environment.

7-4-us-3-018, 2021-03 Printed in Germany  
© Pilz GmbH & Co. KG, 2021

CECE®, CHRE®, CMSE®, InduNET p®, Leansafe®, Master of Safety®, Master of Security®, PAS4000®, PAScal®, PASconfig®, Pilz®, PII®, PLID®, PMCCorimo®, PMCCprotego®, PMCCtendo®, PWD®, PwI®, PNOZ®, PRBT®, PRCM®, Primo®, PRITM®, PSEN®, PSS®, PVIS®, SafetyBUS p®, SafetyEYE®, SafetyNET p®, THE SPIRIT OF SAFETY® are registered and protected trademarks of Pilz GmbH & Co. KG in some countries. We would point out that product features may vary from the details stated in this document, depending on the status at the time of publication and the scope of the equipment. We accept no responsibility for the validity, accuracy and entirety of the text and graphics presented in this information. Please contact our Technical Support if you have any questions.

**PILZ**  
THE SPIRIT OF SAFETY