

**Cable entry system KDSClick**  
 ...a revolutionary cable entry system!

# Turning Cables Inside Out

Fast. Safe. Very simple. Our KDSClick cable entry system is a cable management solution for switchgear cabinets, housings and machines that features secure seals and strain relief for pre-assembled and non-assembled cables – with or without connectors. KDSClick saves you time and provides you with maximum versatility.

It's easy.  
 It's quick.  
 It's  
**KDSClick.**



# Three Parts, Many Solutions

**A frame. An inlay. A seal.**  
**The modular design of these three basic components guarantees maximum versatility, variability and variety.**

## 1. Frame

Made from a single mold, the one-piece frame is quick and easy to assemble. It is made of sturdy, glass-fibre reinforced plastic. The foamed seal guarantees an optimal seal with IP66 protection, even on painted or rough surfaces.



## 2. Inlay

The click-in inlays allow for a requirements-based dimensioning of the frame opening for the seal being used. An audible "click" confirms a correct installation. So you can variably configure cable entries to match various requirements (for cables, lines, tubing, pneumatic and hydraulic lines).



## 3. Seal

The seal's tapered shape allows it to be easily pressed in; it reliably seals the gaps and provides strain relief in accordance with DIN EN 62444. The seals are installed by pressing them from the inside outwards into the openings of the previously installed inlays. Their wave-cut profile makes them easy to install and ensures a perfect fit around the cables. There are currently 82 different seals that can be used for sealing cables of various diameters and sizes.



## Your benefits: more versatility and safety

**The seals can be removed by pressing from the outside inwards. Changes, retrofits, service work or the readjustment of cable lengths can be made when needed without removing the frame. An optional inner locking frame can be used to prevent the possibility of unwanted external manipulation.**

# The Overwhelming Benefits of KDSClick

## Intelligently split seals

Their wave-cut profile split makes them easy to install and ensures a perfect fit around the cables.

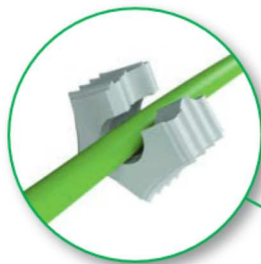

## Quick inside-outwards assembly for easier servicing work

The frame does not need to be disassembled if your requirements change or if you're carrying out service work.



## No loss of guarantee during cable assembly

No need to disassemble and reconnect connectors, so manufacturer's warranty is not voided.

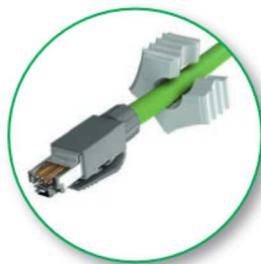

## Very versatile high-density assemblies are possible

1-way, 2-way, and 4-way seals provide you with excellent versatility for cable management

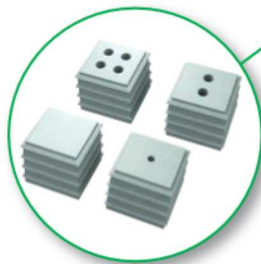

## Attaching the frame

The one-piece frame can be easily and quickly attached to the wall.

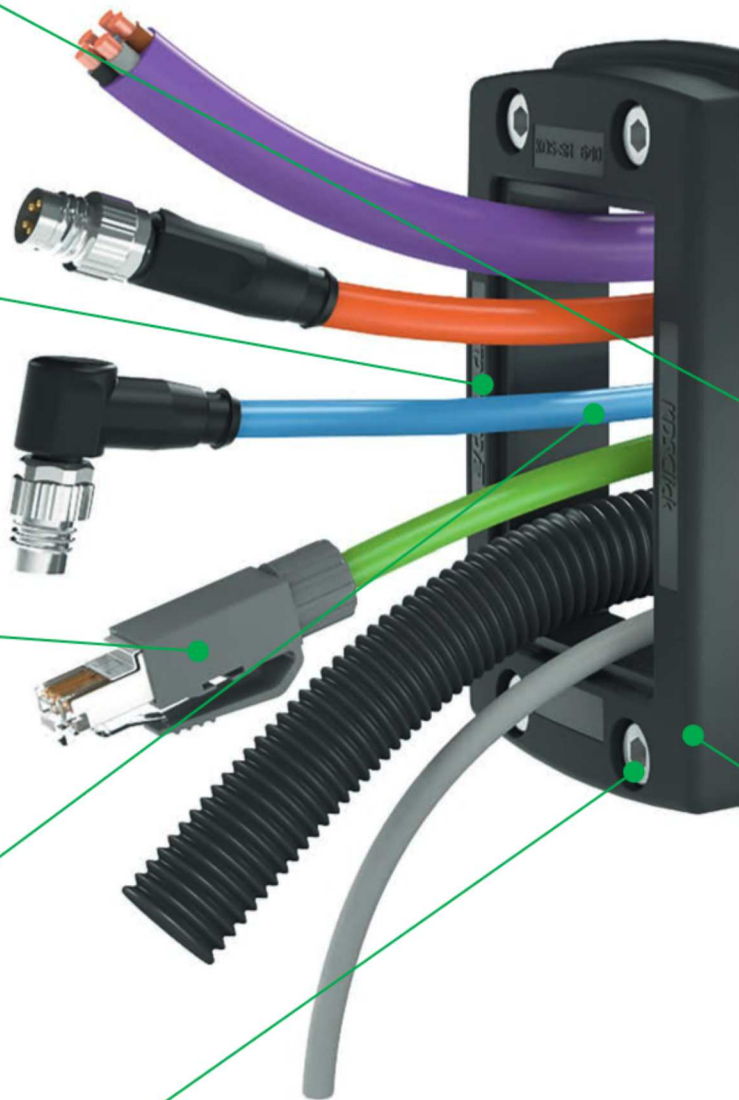
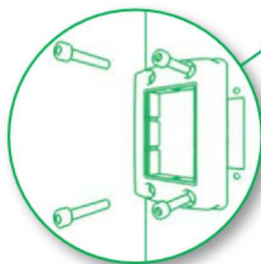

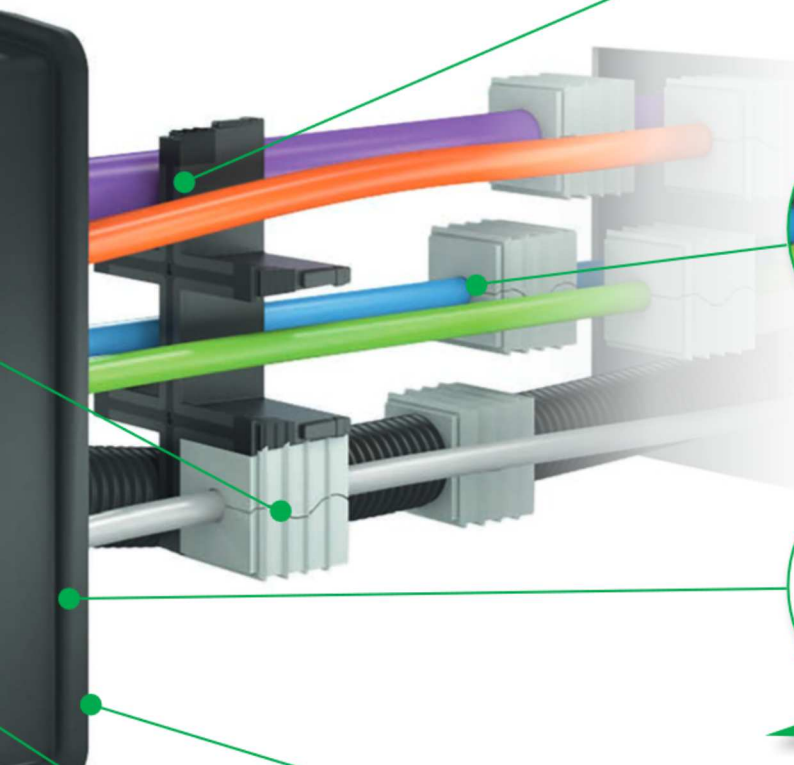

### Outstanding seal: IP66 protection

Multi-resistant, tapered seals feature inner and outer sealing gills.

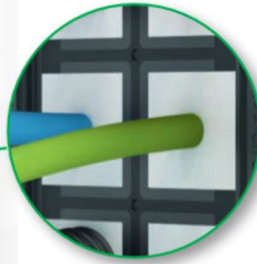

### Integrated strain relief

The secure fit of the seals ensures a strain relief mechanism for the cables, in accordance with DIN EN 62444.



### Safe and quick installation with audible feedback

An audible "click" confirms that the inlay has been correctly installed into the frame.

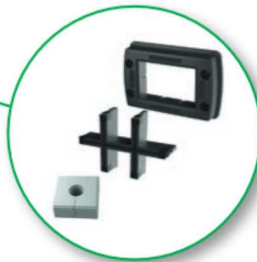

### Maximum versatility with optimized warehousing

The frames, inlays and seals can be combined in many ways – ensuring you many versatile configuration options.

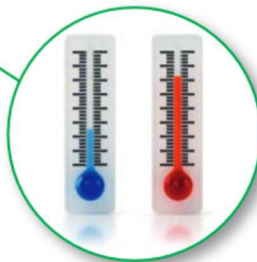

### Can be used from – 40 °C to + 120 °C

Materials contain no halogen or silicone, suitable for many different applications.

# KDSClick: Frames and Inlays

## Features:

- Material: Polyamide PA 6.6, glass-fibre reinforced | TPE
- Color: black
- Flammability: UL94 V-0
- Temperature range: – 40 °C to + 120 °C
- Halogen-free, silicone-free
- Protection: IP66

### KDS-SR 1-4 Combinations



Type	Cat. no.	Description	Qty.
KDS-SR 1-4 BK	28506.4	Screw frame	1
KDS-Set 1-4 BK	28602.4	Set consists of: 1 x KDS-SR 1-4 BK, 1 x KDS-Inlay 4 BK	1

Accessories			
Type	Cat. no.	Description	Qty.
KDS-Inlay 4 BK	28518.4	Inlay for 4-way splits	5
KDS-IVR 1-4 BK	28507.4	Inner locking frame (optional)	10

Seal			
Type	Cat. no.	Description	Qty.
KDS-DE	Page 22	Small seals	10
KDS-DEG	Page 22	Large seals	10

### KDS-SR 6/10 Combinations

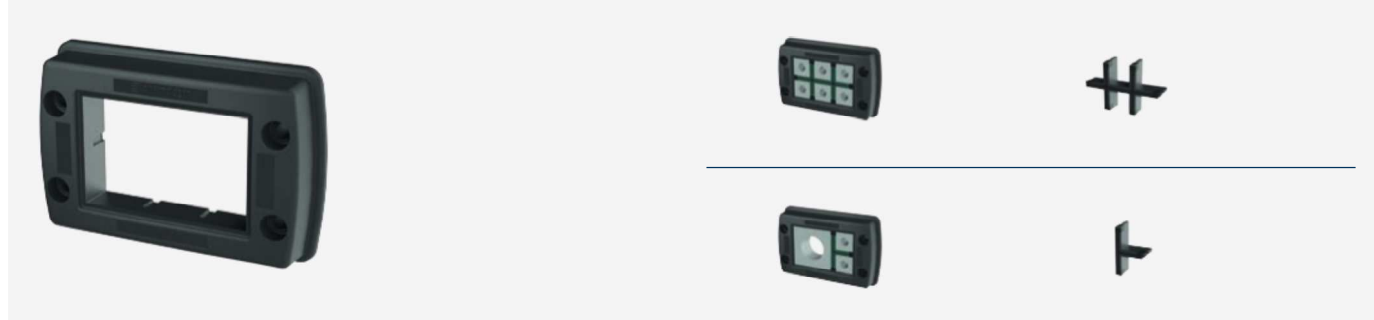

Type	Cat. no.	Description	Qty.
KDS-SR 6/10 BK	28500.4	Screw frame	1
KDS-Set 6/10 BK	28603.4	Set consists of: 1 x KDS-SR 6/10 BK, 1 x KDS-Inlay 2 BK, 1 x KDS-Inlay 6 BK	1

Accessories			
Type	Cat. no.	Description	Qty.
KDS-Inlay 2 BK	28517.4	Inlay, T-shape	5
KDS-Inlay 6 BK	28519.4	Inlay for 6-way splits	5
KDS-IVR 6/10 BK	28501.4	Inner locking frame (optional)	10

Seal			
Type	Cat. no.	Description	Qty.
KDS-DE	Page 22	Small seals	10
KDS-DEG	Page 22	Large seals	10

## KDS-SR 8/16

### Combinations

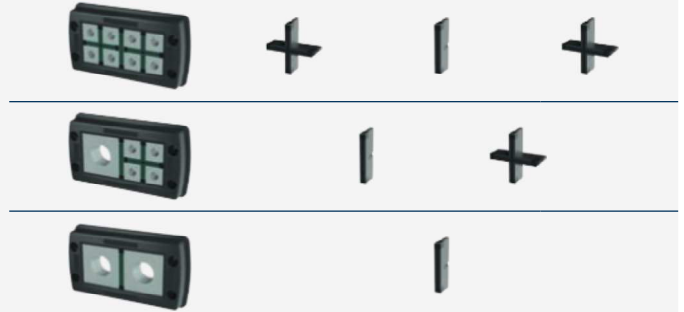

Type	Cat. no.	Description	Qty.
KDS-SR 8/16 BK	28502.4	Screw frame	1
KDS-Set 8/16 BK	28604.4	Set consists of: 1 x KDS-SR 8/16 BK, 1 x KDS-Inlay 1 BK, 2 x KDS-Inlay 4 BK	1

### Accessories

Type	Cat. no.	Description	Qty.
KDS-Inlay 1 BK	28516.4	Inlay for vertical split	5
KDS-Inlay 4 BK	28518.4	Inlay for 4-way splits	5
KDS-IVR 8/16 BK	28503.4	Inner locking frame (optional)	10

Seal	Cat. no.	Description	Qty.
KDS-DE	Page 22	Small seals	10
KDS-DEG	Page 22	Large seals	10

## KDS-SR 10/24

### Combinations

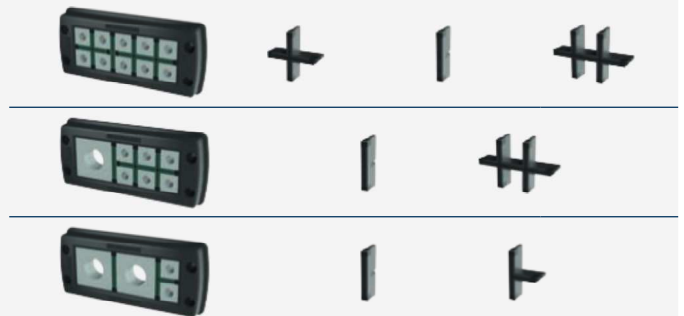

Type	Cat. no.	Description	Qty.
KDS-SR 10/24 BK	28504.4	Screw frame	1
KDS-Set 10/24 BK	28605.4	Set consists of: 1 x KDS-SR 10/24 BK, 1 x KDS-Inlay 1 BK, 1 x KDS-Inlay 2 BK, 1 x KDS-Inlay 4 BK, 1 x KDS-Inlay 6 BK	1

### Accessories

Type	Cat. no.	Description	Qty.
KDS-Inlay 1 BK	28516.4	Inlay for vertical split	5
KDS-Inlay 2 BK	28517.4	Inlay, T-shape for large small	5
KDS-Inlay 4 BK	28518.4	Inlay for 4-way splits	5
KDS-Inlay 6 BK	28519.4	Inlay for 6-way splits	5
KDS-IVR 10/24 BK	28505.4	Inner locking frame (optional)	10

Seal	Cat. no.	Description	Qty.
KDS-DE	Page 22	Small seals	10
KDS-DEG	Page 22	Large seals	10

# KDSClick: Separable Cable Glands

## All-round Solutions

For metric break-outs, CONTA-CLIP provides separable cable glands from M20 to M63 for cables with or without connectors. During servicing or retrofitting with pre-assembled cable harnesses, cables with diameters from 2 to 35 mm can quickly and safely be guided into the switchgear cabinet or housing, and then sealed to IP66. The divisible system ensures quick and simple assembly. The slitted seal has a wave-cut profile that ensures a reliable seal and a totally secure attachment. The seal is first placed around the cable and then inserted in one of the two halves.

Depending on the size of the cable gland, up to four seals can be inserted. After that, the two halves of the cable gland are easily snapped together without the use of any tools. A locknut (which can also be separated) on the inside of the cabinet ensures a safe and secure attachment.



### Outstanding seal: IP66 protection

Multi-resistant, tapered seals feature inner and outer sealing gills.

### Intelligently split seals

Their wave-cut profile makes them easy to install and ensures a perfect fit around the cables.

### Maximum versatility

More than 80 different seal variants are available.

### Versatile assembly

Up to four assembled cables can be used with one cable gland.

### Separable locknut

Easy to attach to cables that have already been guided through.

## The advantages

- Assembled cables can be guided through
- Guarantee retained for assembled cables
- Retrofitting and service work is quick and causes no problems
- High-density assemblies
- Can be installed on standard metric break-outs
- Includes a separable hexagon nut

## Features:

- Material: Polyamide PA 6.6, glass-fibre reinforced | TPE
- Color: black
- Flammability: UL94 V-0
- Temperature range: -40 °C to +120 °C
- Halogen-free, silicone-free
- Protection: IP66

<b>KDS-KV, small version</b>		<b>Combinations</b>	
			
Type	Cat. no.	Description	Qty.
KDS-KV M20 BK	28610.4	Separable cable gland, including separable locknut	10
KDS-KV M25 BK	28611.4	Separable cable gland, including separable locknut	10
KDS-KV M32 BK	28612.4	Separable cable gland, including separable locknut	10
<b>Accessories</b>			
Type	Cat. no.	Description	Qty.
KDS-GM 20 BK	28616.4	Separable locknut	10
KDS-GM 25 BK	28617.4	Separable locknut	10
KDS-GM 32 BK	28618.4	Separable locknut	10
<b>Seal</b>			
Type	Cat. no.	Description	Qty.
KDS-DE	Page 22	Small seals	10

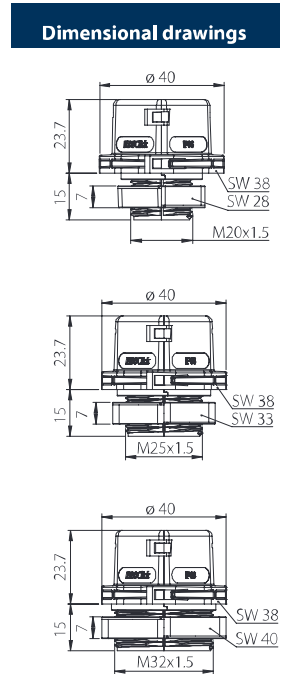

<b>KDS-KV, large version</b>		<b>Combinations</b>	
			
Type	Cat. no.	Description	Qty.
KDS-KV M40 BK	28613.4	Separable cable gland, including separable locknut	5
KDS-KV M50 BK	28614.4	Separable cable gland, including separable locknut	5
KDS-KV M63 BK	28615.4	Separable cable gland, including separable locknut	5
<b>Accessories</b>			
Type	Cat. no.	Description	Qty.
KDS-Inlay 4 BK	28518.4	Inlay for 4-way splits	5
KDS-GM 40 BK	28619.4	Separable locknut	5
KDS-GM 50 BK	28620.4	Separable locknut	5
KDS-GM 63 BK	28621.4	Separable locknut	5
<b>Seal</b>			
Type	Cat. no.	Description	Qty.
KDS-DE	Page 22	Small seals	10
KDS-DEG	Page 22	Large seals	10

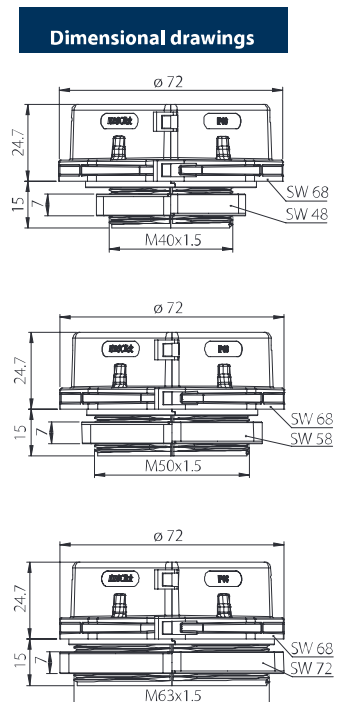

Data sheets, dimensional drawings and 3D models available on request.



# KDSClick: Seals

## Features of black seals:

- Material: TPE
- Flammability: UL94 HB
- Temperature range: -40 °C to +120 °C (static)
- Halogen-free, silicone-free
- Excellent resistance to chemicals
- UV-stabilized
- Protection: IP66

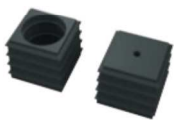

Seals, black small			
Type	Cat. no.:	Max. ø	Qty.
KDS-DE/B BK	28520.4	Blind	10
KDS-DE 1-2 BK	28521.4	2 mm	10
KDS-DE 2-3 BK	28522.4	3 mm	10
KDS-DE 3-4 BK	28523.4	4 mm	10
KDS-DE 4-5 BK	28524.4	5 mm	10
KDS-DE 5-6 BK	28525.4	6 mm	10
KDS-DE 6-7 BK	28526.4	7 mm	10
KDS-DE 7-8 BK	28527.4	8 mm	10
KDS-DE 8-9 BK	28528.4	9 mm	10
KDS-DE 9-10 BK	28529.4	10 mm	10
KDS-DE 10-11 BK	28530.4	11 mm	10
KDS-DE 11-12 BK	28531.4	12 mm	10
KDS-DE 12-13 BK	28532.4	13 mm	10
KDS-DE 13-14 BK	28533.4	14 mm	10

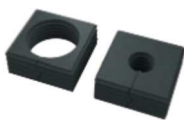

Seals, black large			
Type	Cat. no.:	Max. ø	Qty.
KDS-DEG/B BK	28534.4	Blind	10
KDS-DEG 14-15 BK	28535.4	15 mm	10
KDS-DEG 15-16 BK	28536.4	16 mm	10
KDS-DEG 16-17 BK	28537.4	17 mm	10
KDS-DEG 17-18 BK	28538.4	18 mm	10
KDS-DEG 18-19 BK	28539.4	19 mm	10
KDS-DEG 19-20 BK	28540.4	20 mm	10
KDS-DEG 20-21 BK	28541.4	21 mm	10
KDS-DEG 21-22 BK	28542.4	22 mm	10
KDS-DEG 22-23 BK	28543.4	23 mm	10
KDS-DEG 23-24 BK	28544.4	24 mm	10
KDS-DEG 24-25 BK	28545.4	25 mm	10
KDS-DEG 25-26 BK	28546.4	26 mm	10
KDS-DEG 26-27 BK	28547.4	27 mm	10
KDS-DEG 27-28 BK	28548.4	28 mm	10
KDS-DEG 28-29 BK	28549.4	29 mm	10
KDS-DEG 29-30 BK	28550.4	30 mm	10
KDS-DEG 30-31 BK	28551.4	31 mm	10
KDS-DEG 31-32 BK	28552.4	32 mm	10
KDS-DEG 32-33 BK	28601.4	33 mm	10



Cone-shaped seals, black			
Type	Cat. no.:	Max. ø	Qty.
KDS-DE/K 2-15 BK	28553.4	15 mm	10
KDS-DEG/K 15-34 BK	28554.4	34 mm	10



Seals, black with multiple holes			
Type	Cat. no.:	Max. ø	Qty.
KDS-DE 2X4-5 BK	28555.4	5 mm	10
KDS-DE 2X5-6 BK	28556.4	6 mm	10
KDS-DE 4X2-3 BK	28557.4	3 mm	10
KDS-DE 4X3-4 BK	28558.4	4 mm	10



Seals, black AS-Interface cables			
Type	Cat. no.:		Qty.
KDS-DE/1XASI BK	28559.4		10
KDS-DE/2XASI BK	28560.4		10

## Features of grey seals:

- Material: TPE
- Flammability: UL94 V-0
- Temperature range: -40 °C to 90 °C (static)
- Halogen-free, silicone-free
- Protection: IP66

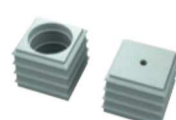

Seals, grey small			
Type	Cat. no.:	Max. ø	Qty.
KDS-DE/B GR	28561.6	Blind	10
KDS-DE 1-2 GR	28562.6	2 mm	10
KDS-DE 2-3 GR	28563.6	3 mm	10
KDS-DE 3-4 GR	28564.6	4 mm	10
KDS-DE 4-5 GR	28565.6	5 mm	10
KDS-DE 5-6 GR	28566.6	6 mm	10
KDS-DE 6-7 GR	28567.6	7 mm	10
KDS-DE 7-8 GR	28568.6	8 mm	10
KDS-DE 8-9 GR	28569.6	9 mm	10
KDS-DE 9-10 GR	28570.6	10 mm	10
KDS-DE 10-11 GR	28571.6	11 mm	10
KDS-DE 11-12 GR	28572.6	12 mm	10
KDS-DE 12-13 GR	28573.6	13 mm	10
KDS-DE 13-14 GR	28574.6	14 mm	10

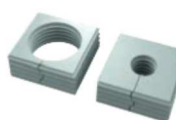

Seals, grey large			
Type	Cat. no.:	Max. ø	Qty.
KDS-DEG/B GR	28575.6	Blind	10
KDS-DEG 14-15 GR	28576.6	15 mm	10
KDS-DEG 15-16 GR	28577.6	16 mm	10
KDS-DEG 16-17 GR	28578.6	17 mm	10
KDS-DEG 17-18 GR	28579.6	18 mm	10
KDS-DEG 18-19 GR	28580.6	19 mm	10
KDS-DEG 19-20 GR	28581.6	20 mm	10
KDS-DEG 20-21 GR	28582.6	21 mm	10
KDS-DEG 21-22 GR	28583.6	22 mm	10
KDS-DEG 22-23 GR	28584.6	23 mm	10
KDS-DEG 23-24 GR	28585.6	24 mm	10
KDS-DEG 24-25 GR	28586.6	25 mm	10
KDS-DEG 25-26 GR	28587.6	26 mm	10
KDS-DEG 26-27 GR	28588.6	27 mm	10
KDS-DEG 27-28 GR	28589.6	28 mm	10
KDS-DEG 28-29 GR	28590.6	29 mm	10
KDS-DEG 29-30 GR	28591.6	30 mm	10
KDS-DEG 30-31 GR	28592.6	31 mm	10
KDS-DEG 31-32 GR	28593.6	32 mm	10
KDS-DEG 32-33 GR	28594.6	33 mm	10

Seals, grey with multiple holes			
Type	Cat. no.:	Max. ø	Qty.
KDS-DE 2X4-5 GR	28595.6	5 mm	10
KDS-DE 2X5-6 GR	28596.6	6 mm	10
KDS-DE 4X2-3 GR	28597.6	3 mm	10
KDS-DE 4X3-4 GR	28598.6	4 mm	10



Seals, black AS-Interface cables			
Type	Cat. no.:		Qty.
KDS-DE/1XASI GR	28599.6		10
KDS-DE/2XASI GR	28600.6		10

