

Wire mesh tray 400 mm

Wire mesh tray electro-galvanized, for versatile installations. Ø 6 mm wire, length 2.5 m, height 58 mm. Several of the accessories are shared with the remainder of the MP range. Can be ordered in optional colour finish. Corrosivity class max C1.

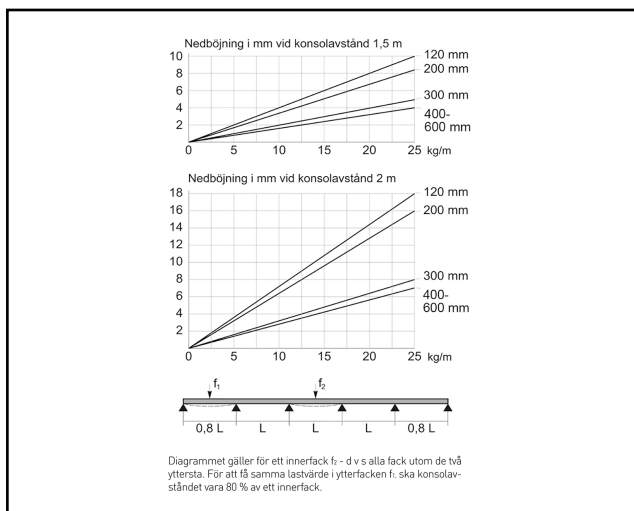
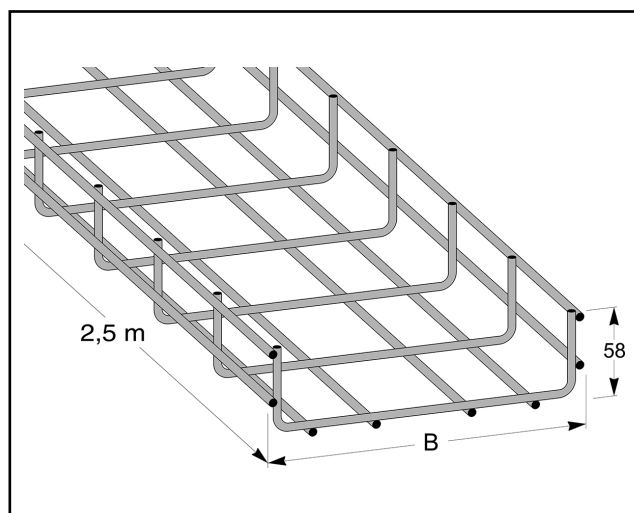
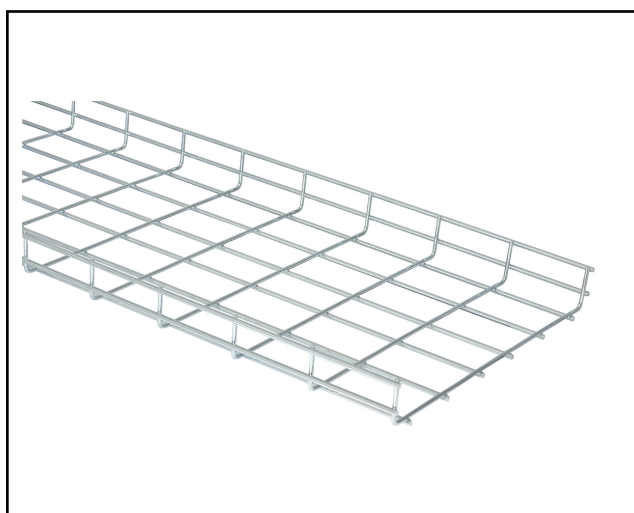

MP-no	GTIN	Dimension (LxBxH) mm	Weight kg	Surface	Max env. class	Pieces/pack.
725E	7394333051819	2500x400x58	7.50	Electro-galvanized 10 µm	C1	2