

Tray splice 600 mm

Splice for tray/luminaire rail with in-built support yoke. Can be locked with clips MP-906 (11 176 40).
Max load for support yoke in splice = 150 kg evenly distributed load. Ultimate failure load: greater than or equal to 1.7 times the maximum load.

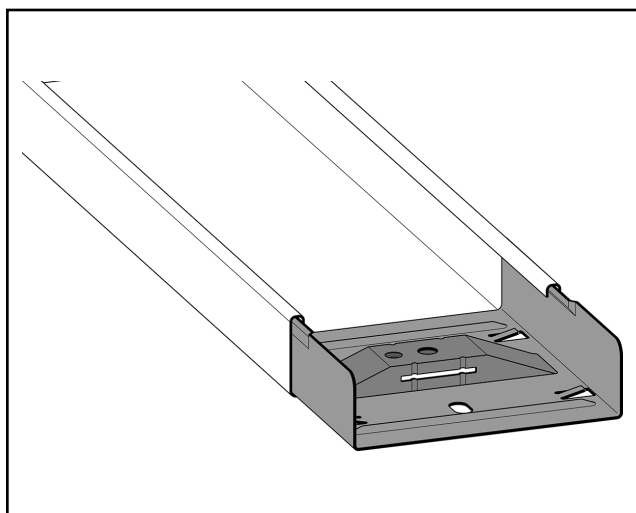
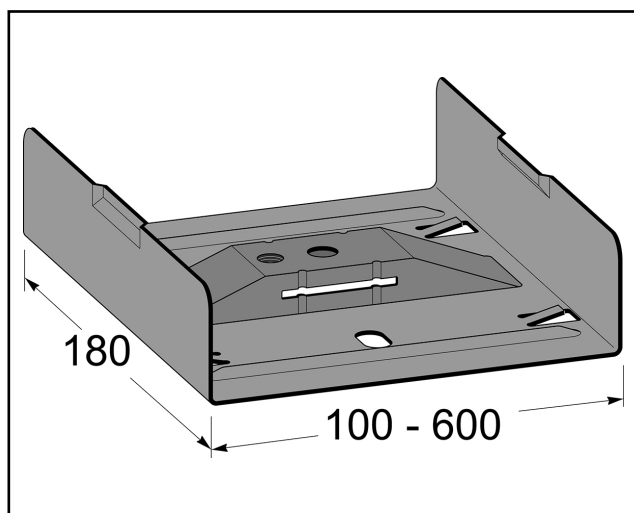
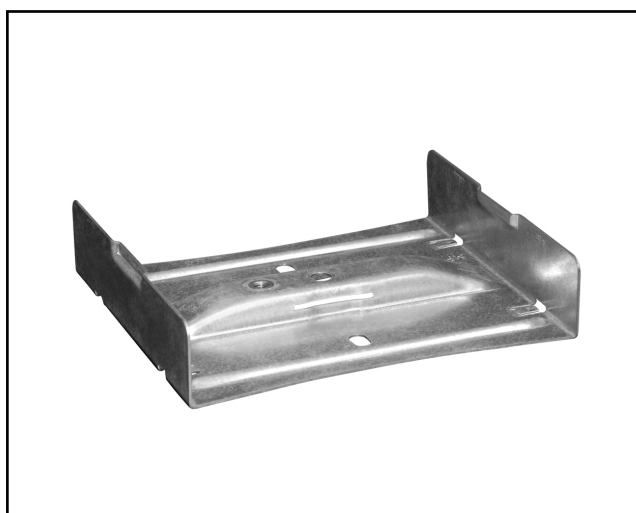

MP-no	GTIN	Dimension (LxBxH) mm	Weight kg	Surface	Max env. class	Pieces/ pack.
384S	7394333124629	596x180x42	1.19	Pre-galvanised sheet metal 20	C2	