

# Tee piece ladder 400 mm

Use six splices MP-107 per junction. NB! Widths 400-600 have several pins.

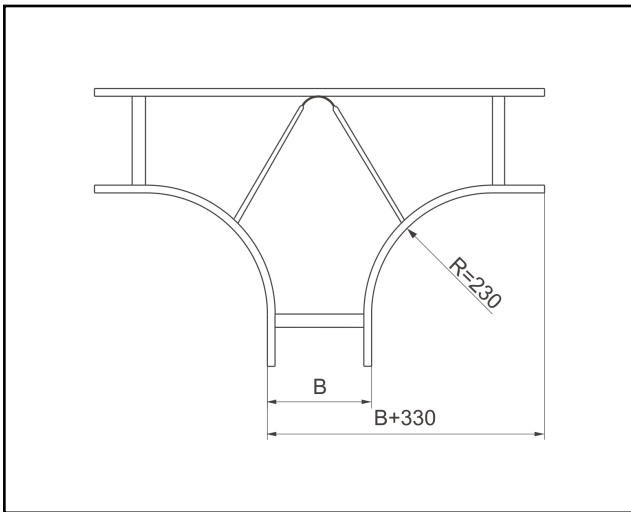
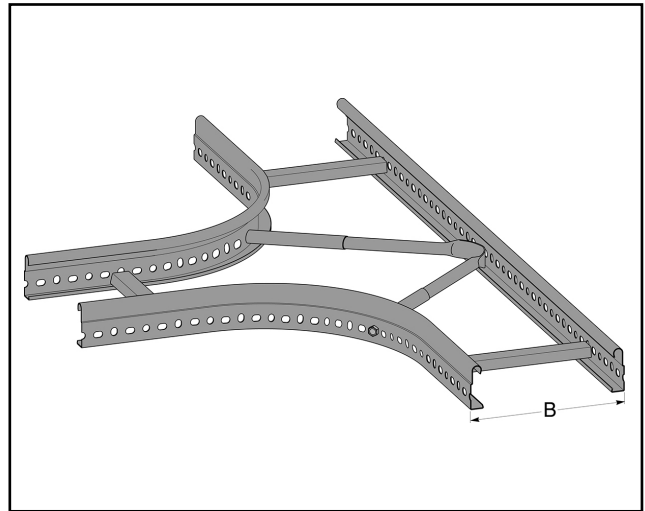

MP-no	GTIN	Dimension (LxBxH) mm	Weight kg	Surface	Max env. class	Pieces/ pack.
134S	7394333018843	730x1060x56	3.48	Pre-galvanised sheet metal 20	C2	