

Cable ladder 3 m 600 mm

Meet EL AMA's requirements for heavy cable ladders. Available on request in painted finish. Rung spacing c-c 250 mm. Ultimate failure load: greater than or equal to 1.7 times the maximum load.

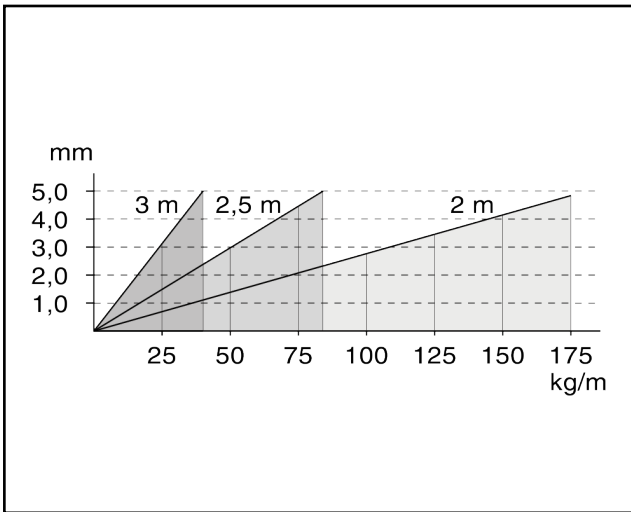
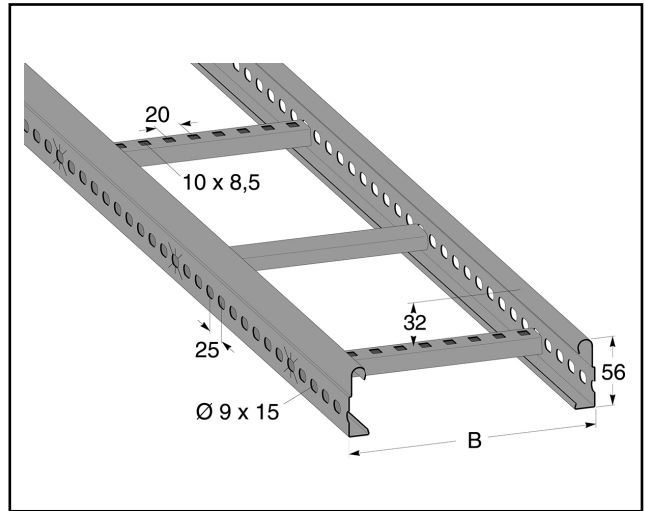
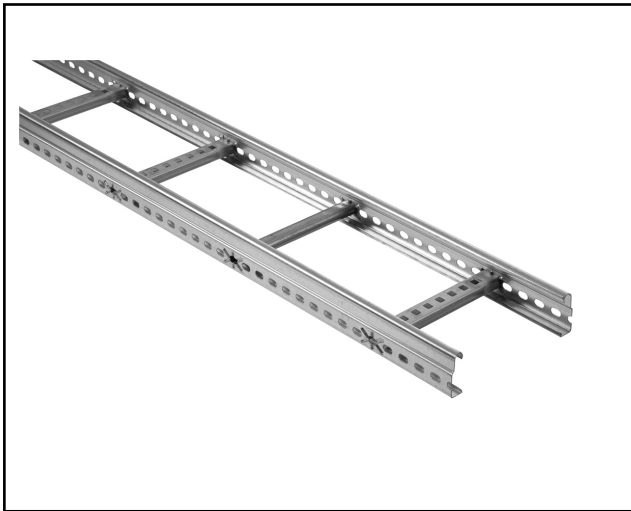

MP-no	GTIN	Dimension (LxBxH) mm	Weight kg	Surface	Max env. class	Pieces/pack.
106S	7394333000503	3000x600x56	7.19	Pre-galvanised sheet metal 20	C2	6