

Cable ladder 3 m 300 mm

Meet EL AMA's requirements for heavy cable ladders. Available on request in painted finish. Rung spacing c-c 250 mm. Ultimate failure load: greater than or equal to 1.7 times the maximum load.

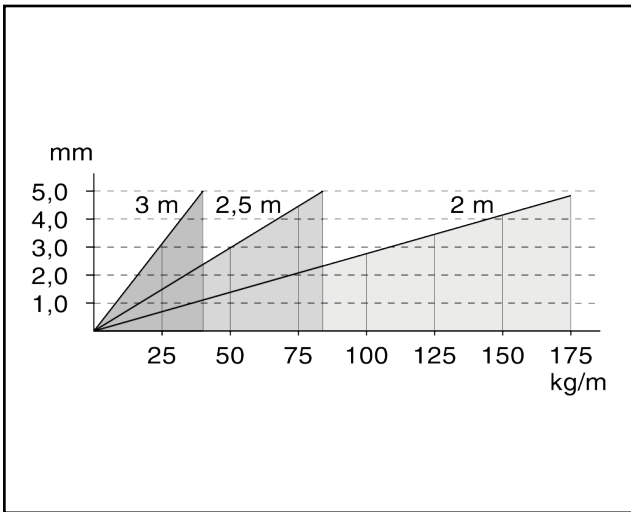
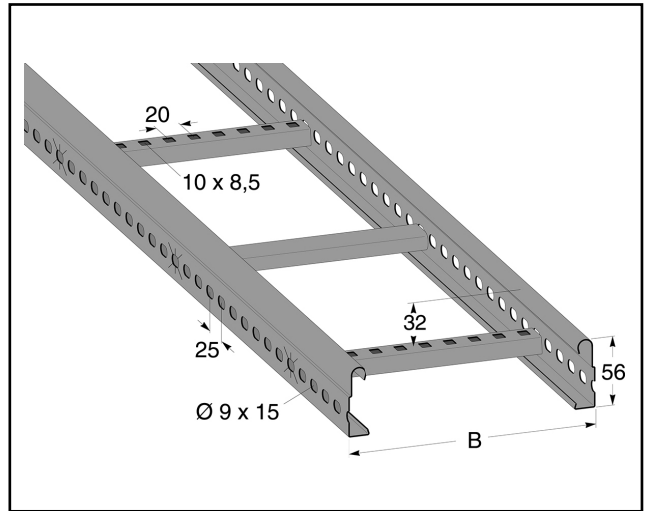
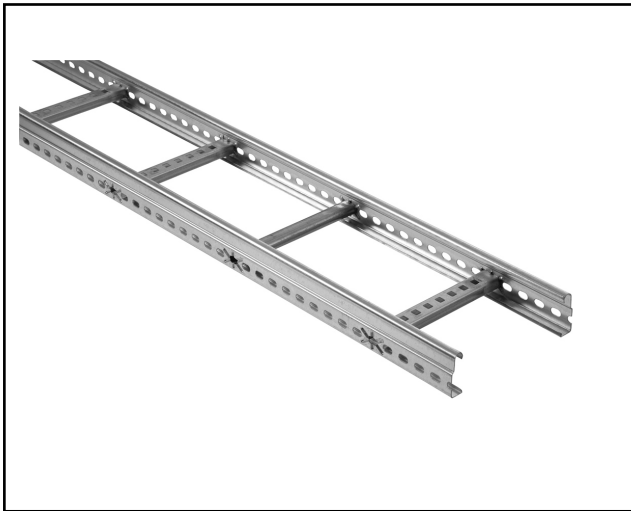

MP-no	GTIN	Dimension (LxBxH) mm	Weight kg	Surface	Max env. class	Pieces/pack.
103S	7394333000213	3000x300x56	5.68	Pre-galvanised sheet metal 20	C2	6