

Angled plug - with inward-curving cable sleeve



Product description	
BALS-Prd.-Nr	231
EAN	4024941002318
Product category	angled plug
Current	16A
Number of poles	3p
Arrangement of phases	2P+PE
Position of earth contact	6 h
Voltage	200 - 250V~
Frequency	50/60Hz

Product description	
Protection degree	IP44
Colour code	blue RAL 5015
Colour of appliance	Collar blue RAL 5015, anti-kink sleeve grey RAL 7035, Enclosure grey RAL 7035
Connection design	with screw terminal
Maximum conductor size	2,5 qmm
Cable entry	Anti-kink sleeve
Height	89mm
Width	51mm
Depth	78mm
Material of enclosure	Polyamide
Contacts	The contact carrier is made of polyamide, The contacts are brass

Additional technical information	
	With internal cable sleeve, With short cable sleeve

Logistics data	
Weight/pcs	0.125 kg / Piece
Packaging	Bag
Content amount	1 ST
EAN	4024941002318
Length	51 mm

Logistics data	
Width	78 mm
Height	89 mm
Weight	0.126 kg
Volume	354.042 ccm
Packaging	Carton
Content amount	10 ST
EAN	4024941968201
Length	275 mm
Width	175 mm
Height	137 mm
Weight	1.375 kg
Volume	5,737.5 ccm

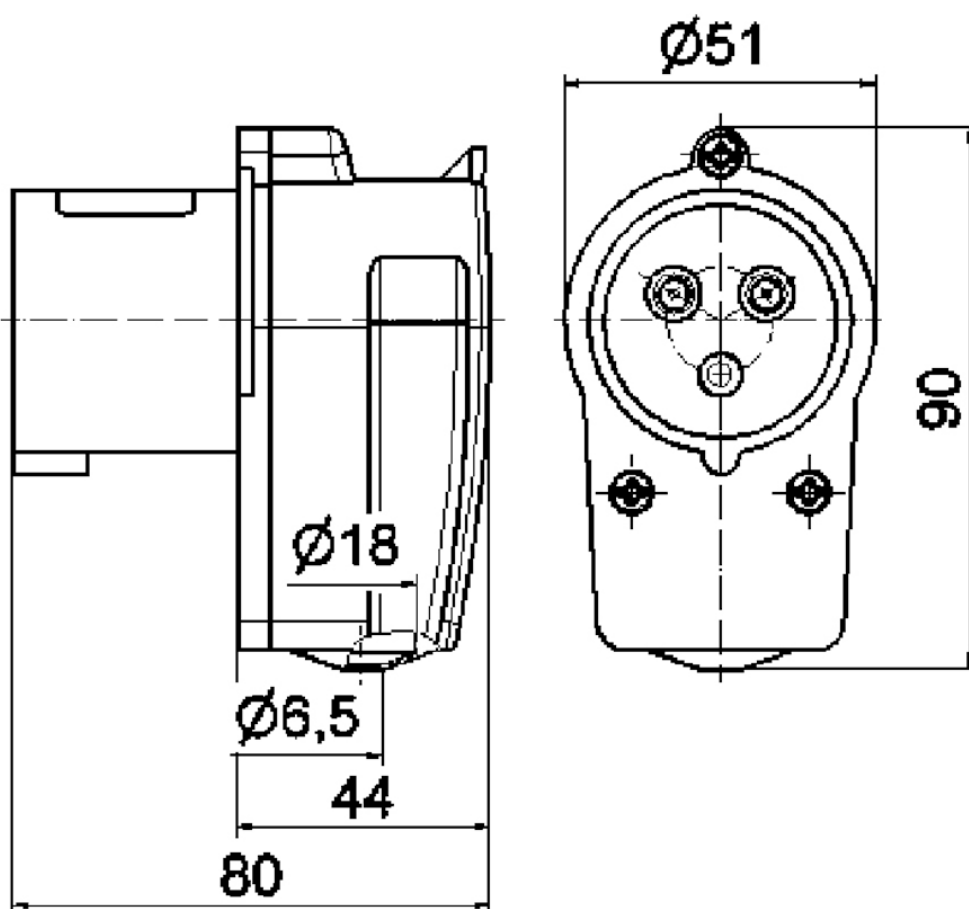

2 MB 156