

EN Flush-mounted universal dimmer

DIMAX 544 plus P
5440130



1. Basic safety information 3

2. Proper use 3

Disposal 4

3. Installation and connection 5

Mounting the dimmer 5

Connecting the dimmer 6

4. Settings and functions – operation via app 8

Connecting universal dimmer and smartphone (via MAXplus app) 8

Dimming – brightness levels –
staircase light – comfort –
settings 10

Scenes 15

Assign/change password/
PIN 16

5. Push button operation 18

1. Auto operating mode
(default) 18

2. Staircase light operating
mode 19

6. Technical data 20

7. Contact 21



1. Basic safety information



WARNING

Danger of death through electric shock or fire!

- Installation should only be carried out by a qualified electrician!

- ① Due to continuing technical progress, abnormalities in dimming response or radio interference cannot be ruled out when operating dimmed lamps (in particular LEDs)
- ① In order to achieve a good result, several dimmable LEDs should always be of the same type.
 - The flush-mounted universal dimmer conforms to EN 60669-2-1 if correctly installed

2. Proper use

- The universal dimmer switches and dims the brightness of different lamps such as bulbs, high-voltage halogen lamps, low-voltage halogen lamps (conventional or with electronic transformer) or dimmable LED lamps for 230 V as well as fans
- The brightness can be adjusted by using the buttons connected to the dimmer and/or via app
- The universal dimmer is equipped with a "gentle" lamp conserving function for switching on and off, automatic detection of the load type, overheating protection against overload as well as short-circuit protection

- For use in private and public residential construction, in closed rooms
- Suitable for retrofitting
- Convenient control via smartphone with Theben MAXplus app via Bluetooth V4.2

Disposal

- Dispose of device in environmentally sound manner



3. Installation and connection

- ① When the mains returns, the lamp illuminates briefly for load detection.

Mounting the dimmer



WARNING

Danger of death through electric shock or fire!

- Installation should only be carried out by a qualified electrician!

- Disconnect power source
- Ensure device cannot be switched on
- Check absence of voltage
- Earth and bypass
- Cover or shield any adjacent live components

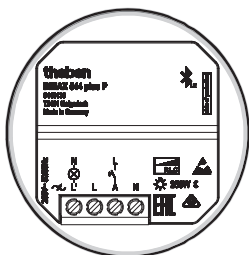
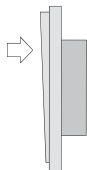

- Install in conventional flush-mounted boxes (according to DIN 49073)

Connecting the dimmer

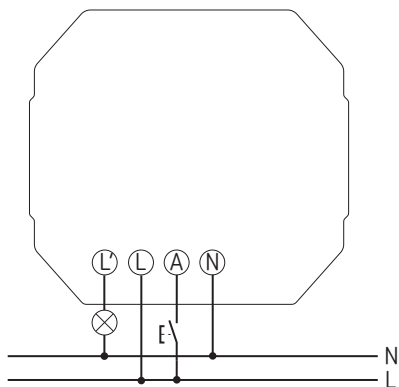

① Several dimmers can be controlled with one button.



Risk of electric shock!

The device does not have basic insulation around the terminals/plugs!

- Protect against accidental contact during installation.
- Maintain a minimum distance of 3 mm from live parts or use additional insulation, e.g. separating strips/walls.
- Always operate electronic and conventional transformers with the minimum load specified by the manufacturer.
- Only use dimmable LED lamps, as normal LED lamps may be destroyed.
- When changing the lamps, switch off the power supply (at the fuse box) so that the automatic load detection is reactivated.
- Do not connect dimmer load connections (L´) in parallel.
- Do not bypass or short-circuit the dimmer.
- Do not install any isolating or variable transformers before the dimmer.
- Do not mix wound and electronic transformers in the installation.
- Do not mix wound transformers and LEDs in the installation.
- Do not connect buttons with glow lamps.
- Correct automatic load detection is only possible with a connected load.
- Only use transformers approved by the manufacturer for dimmer operation.



4. Settings and functions – operation via app

Connecting universal dimmer and smartphone (via MAXplus app)

The universal dimmers can be programmed using an app (from Android 4.4, iOS 8) on mobile devices. Communication takes place via Bluetooth BLE.

- Download the MAXplus app from the App Store or Google Play Store.



- Start the app and push + at the top right (see Fig.)
 - Device list with serial numbers appears
- Select the device
- Confirm with OK
 - Window for entering dimming values, brightnesses, etc. opens
 - Dimmer is now connected and displayed on the start screen





- Settings, software info
- Menu „+“: Search for new device
- Selection of the known devices
- Scenes: Define, delete etc. new scenes
- Devices marked as a favourite



- Menu „Known devices“
- + search for new devices ...
- delete
- edit: change password, name
- update
- grey icon → no connection yet
- blue icon → connection available
- icon with „!“ → password has been changed

Select dimmer

- Select the device
- Confirm with OK

→ Window for entering dimming values, brightnesses, etc. opens

Dimming – brightness levels – staircase light – comfort – settings



→ Functions as dimming, staircase light, comfort and settings (with alternative dimming curves) can be selected.

① If the star is activated (yellow), the device appears as a favourite on the start screen.



1. Dimming

→ Enter the desired dimming value from 1 – 100%

- ① The lightbulb is used for switching on and off; the dimming value can be entered via the bar arrangement, or directly via the pencil

2. Brightness levels

→ Minimum, maximum brightness, switch-on brightness in %, memory function "Save last switch-on brightness"

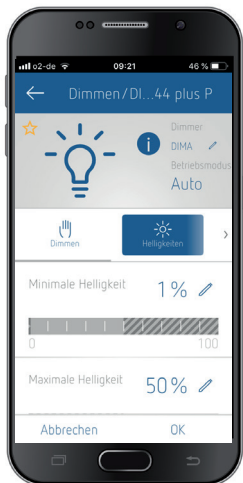

3. Staircase light

① Has to be activated in → Setting → Operating mode "staircase light"



- You can select the staircase light time, the dimming level for the switch-off pre-warning and the behaviour when pressing the button again.
- Long time function 60 mins: activation by pressing the button for longer (confirmed by change in brightness)

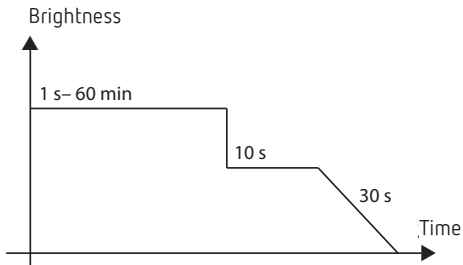

4. Comfort

① Has to be activated in → Setting → Operating mode "auto"

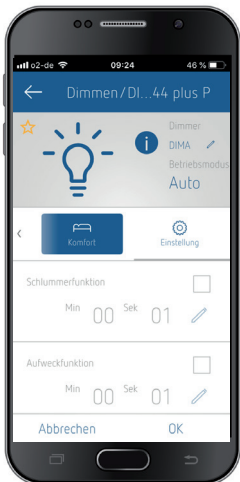

→ Snooze and wake-up function, adjustable in s – min



5. Setting

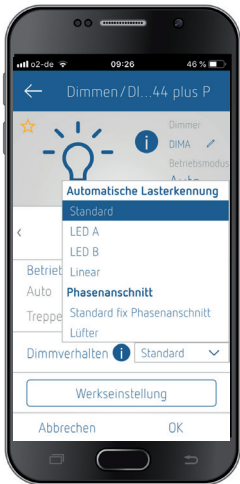

→ Operating mode selectable:

- Auto (dimmer function with comfort function)
- Staircase light
- Dimming response: standard, LED A, LED B, linear, leading edge, standard fix leading edge, fan
- Factory setting: Settings will be reset to the factory setting

Scenes

Here, you can create, delete or edit a new scene.

- ① The current state of the dimmer can be saved as a scene.
If several dimmers are present, various dimmer states can be combined in one scene.

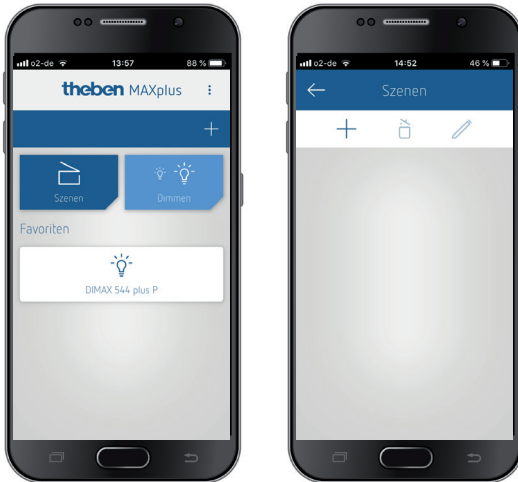

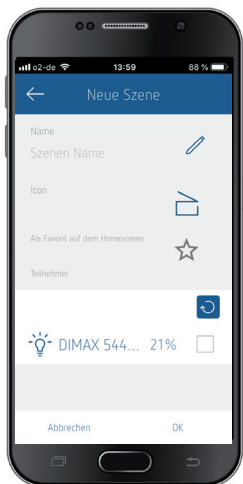

Assign/change password/PIN

If you have activated → „Shared PIN“ under Settings, this PIN will be suggested for all other devices and can thus be adopted.

If you want to change the PIN, you can do this in the menu → Edit → Assign password.

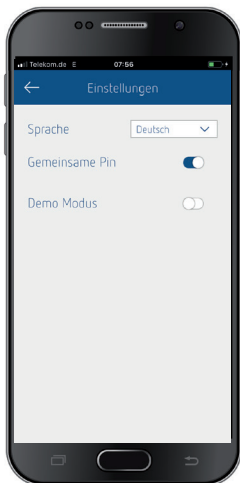

5. Push button operation

1. Auto operating mode (default)

- ① The memory function as well as wake-up and snooze function can be activated/deactivated in the app.

Light is OFF (with button: Input A)

1 x short button press	< 0.5 s	Memory function (if activated in the app) The dimmer switches on with the last brightness value saved prior to switch-off.
1 x short button press	< 0.5 s	If the memory function is not activated in the app , the dimmer starts with the learned switch-on brightness (factory setting: 100%)
1 x long button press	> 0.5 s	Dimming switch-on function The dimmer switches on with minimum brightness and dims until the button is released again, or the maximum brightness has been reached.
2 x short button press		Wake-up function Dimmer switches on with minimum brightness, then dims to 100% within the set dimming time (factory setting: 5 min).

Light is ON (with button: Input A)

1 x short button press	< 0.5 s	Switch off
1 x long button press	> 0.5 s	Dimmer dims up or down. Dimming stops at minimum or maximum value. The dimming direction is changed by pressing the button again.
2 x short button press		Snooze function The dimmer dims to minimum brightness within the set dimming time and switches off (factory setting: 5 min).
1 x long button press	> 15 s	all dimmers are off

2. Staircase light operating mode

① The staircase light function must be activated in the app.

Light is OFF (with button: Input A)

1 x short button press	< 0.5 s	Staircase light is activated
1 x long button press	> 2 s	60 minute extended function is activated

Light is ON (with button: Input A)

1 x short button press	< 0.5 s	can be switched off: off secondary switching: staircase light time is restarted
1 x long button press	> 2 s	60 minute extended function is activated
1 x long button press	> 2 s	If the extended function is active, it will be switched off



6. Technical data

	Trailing edge	Leading edge
Operating voltage	230 V +10% / -15%	
Frequency	50/60 Hz	
Standby output	0.2 W	
Load types	R/L/C	
Minimum load	5 W	
Incandescent/halogen lamp load	250 W (up to 25 °C) 200 W (up to 45 °C)	
Dimmable LEDs (typical)	250 W (up to 25 °C) 200 W (up to 45 °C)	24 W (up to 25 °C) 12 W (up to 45 °C)
Electronic transformers (C)	250 W (up to 25 °C) 200 W (up to 45 °C)	
Inductive transformers (L)		200 W (up to 25 °C) 130 W (up to 45 °C)
Fan	–	50 W
Cable length	max. 50 m	
Cable cross-section	max. 4 mm ²	
Pollution degree	2	
Permissible ambient temperature	-25 °C ... +45 °C	
Radio frequency/transmission power	BLE 2.4 GHz Class 2 (2.5 mW)	



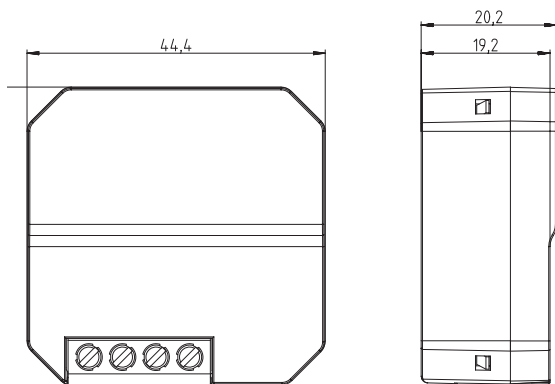

Theben AG herewith declares that this type of radio installation complies with Directive 2014/53/EU. The complete text of the EU Declaration of Conformity is available at the following Internet address:
www.theben.de/red-konformitaet

7. Contact

Theben AG

Hohenbergstr. 32
72401 Haigerloch
GERMANY

Phone +49 7474 692-0
Fax +49 7474 692-150

Hotline

Phone +49 7474 692-369
hotline@theben.de

Addresses, telephone numbers, etc.
www.theben.de