

- TR 611 top3
6110130
- TR 611RC top3
6110330
- TR 622 top3
6220130



1. Basic safety information



WARNING

Danger of death through electric shock or fire!

- Installation should only be carried out by a qualified electrician!

- The device is designed for installation on DIN top hat rails (in accordance with EN 60715)
- Corresponds to type 1 STU in accordance with IEC/EN 60730-2-7
- Power reserve (10 years) is reduced when Bluetooth OBELISK top3 is connected (in battery mode)
- Software: Class A

2. Proper use

- Digital time switch with weekly program, annual program
- Interface for Bluetooth OBELISK top3 (app)
- Time switch with 2 channels (6220130)
- The time switch is used for lighting, ventilation, flushing, etc.
- Only for use in closed, dry rooms

! Do not use on safety devices, e.g. escape route doors, fire safety equipment, etc.

Disposal

- Dispose of device in environmentally sound manner

3. Installation and connection

Mounting the time switch



WARNING

Danger of death through electric shock or fire!

- Installation should only be carried out by a qualified electrician!

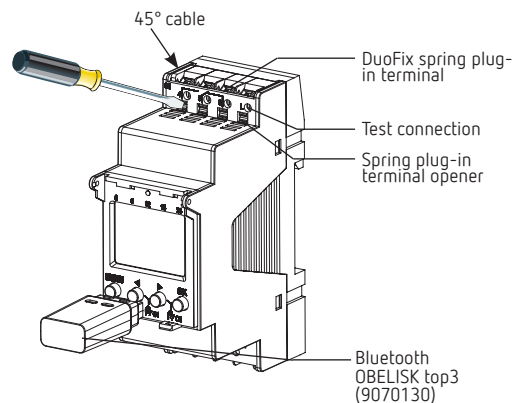
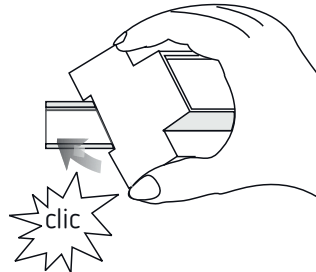

! Check the depth of the control cabinet when OBELISK top3 is connected. The depth must be > 94 mm.

- Mount on DIN top hat rail (as defined in EN 60715)
- Disconnect power source
- Ensure device cannot be switched on
- Check absence of voltage
- Earth and bypass
- Cover or shield any adjacent live components

Wiring diagrams

- ① Additional power unit required for GPS if only one device is connected to the antenna.
- ① Refer to the operating instructions when connecting a GPS antenna (9070610).

Minimum number of participants needed to operate the GPS antenna:

- 2 x weekly timer TR 611 top3 RC, SELEKTA 171 top3 RC LUNA 121 – 122 top3 RC each with 50 mA feed, or
- 1 x weekly timer with 50 mA feed plus 1 x top2 GPS power unit (9070892) with 50 mA feed

Connecting the time switch

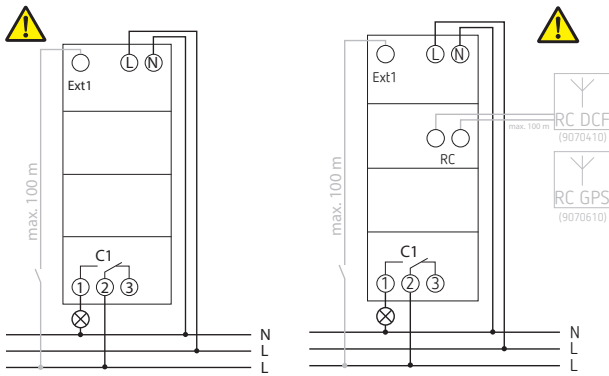

6110130

6110330

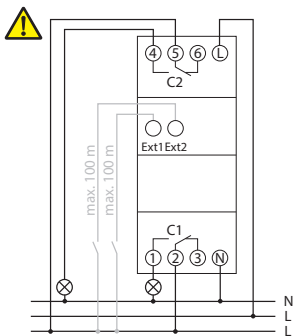

6220130

Connecting the cable

- Strip cable to 8 mm (max. 9)
- Insert cable in the open DuoFix plug-in terminal at 45°
 - ① 2 cables per terminal position possible
- To open the DuoFix plug-in terminal, press screwdriver downwards

Disconnecting the cable

- Use the screwdriver to push the spring plug-in terminal downwards

4. Device description

Display & buttons

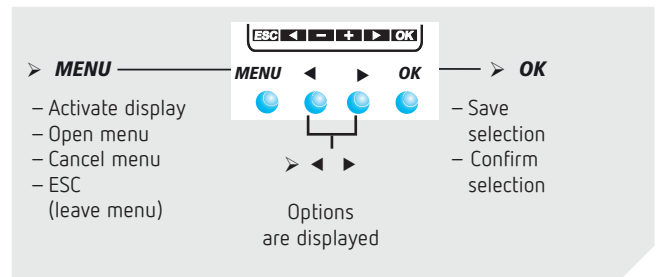
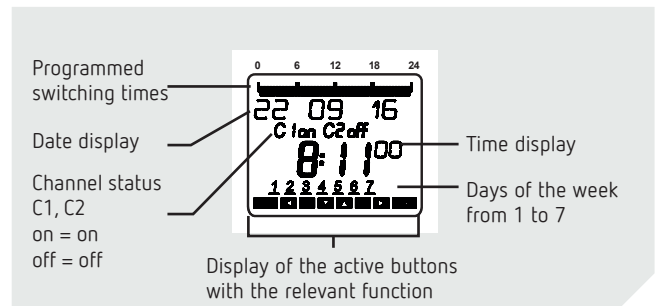

Operating instructions

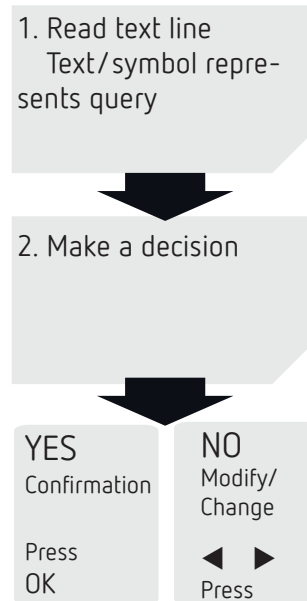

Overview of navigation menu

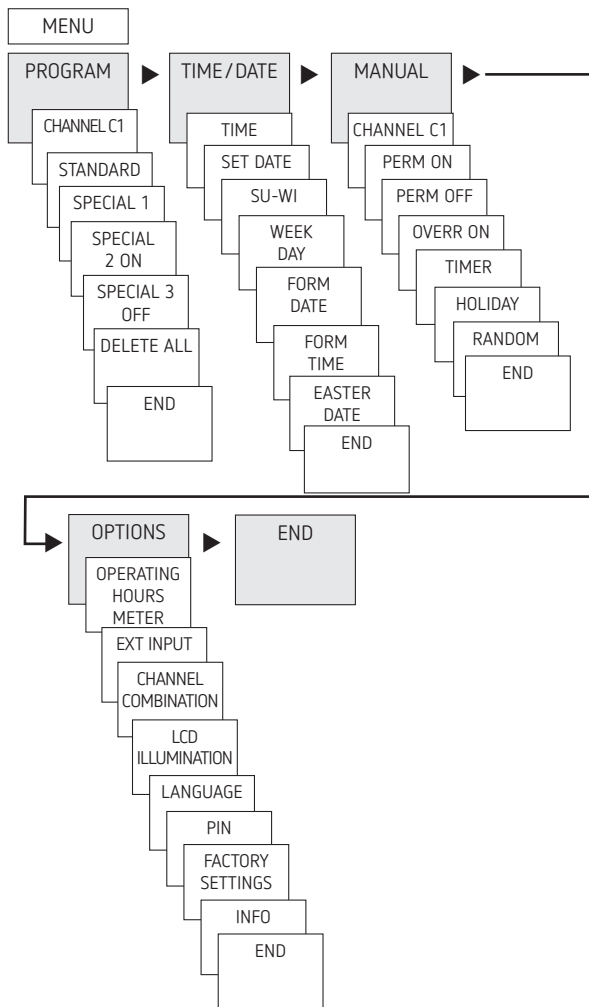

Initial operation

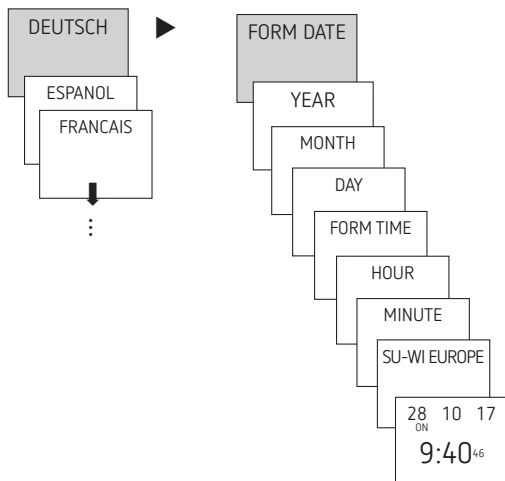

- Set language, date, time as well as summer/winter time (SU-WI)
- Press any button and follow on-screen instructions (see picture)

5. Settings and functions

Setting the switching time

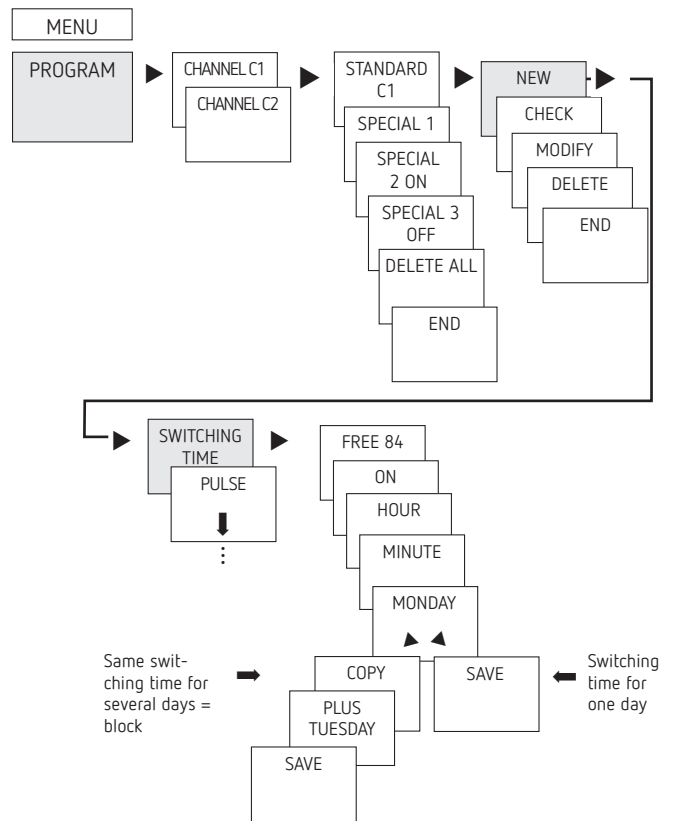

① A switching time always consists of an ON switching operation and an OFF switching operation

① There are 84 memory cells available

Example: Switch on sports hall lighting from Mon–Fri, 7:30 to 12:00

- Press MENU
- Select PROGRAM, confirm with OK
- Select CHANNEL C1 or C2, confirm with OK
- Select STANDARD, confirm with OK
- Select NEW, confirm with OK
- Select SWITCHING TIME, confirm with OK
- Select ON (for turn-on time) or OFF (for turn-off time), confirm with OK
- Set required turn-on time (Mo–Fr, 7:30), confirm with OK
- Select COPY, confirm with OK
- PLUS TUESDAY is displayed, confirm by pressing OK and also confirm the days We, Th, Fr by pressing OK.
- Continue with ► until SAVE is displayed.
- Confirm with OK.

Repeat all steps for the turn-off time, however instead of selecting ON with ► select OFF and enter 12:00 for hour and minute

Changing switching times

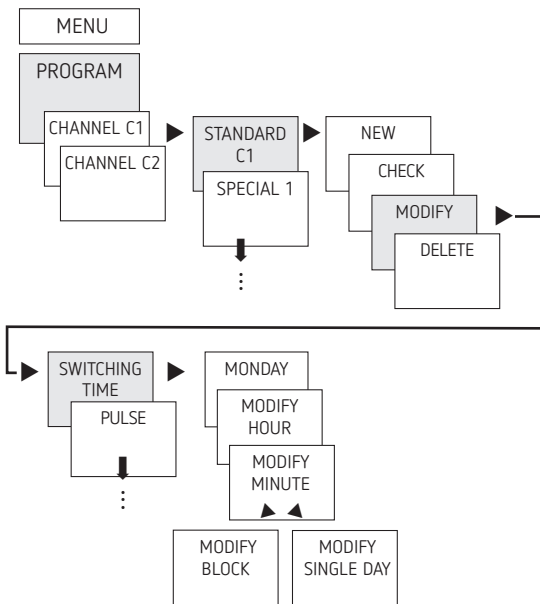

① You can either modify a block, i.e. a switching time copied for several days (e.g. Mon-Fri) or a single switching time

Modifying individual switching times

- Press MENU
- Select PROGRAM, confirm with OK
- Select CHANNEL C1 or C2, confirm with OK
- Select STANDARD, confirm with OK
- Select MODIFY, confirm with OK
- Select SWITCHING TIME, confirm with OK
- Select day, confirm with OK
- MODIFY HOUR, use the + or – buttons to change hour and minute and confirm with OK
- To change several switching times, select MODIFY BLOCK, confirm with OK

Deleting a switching time

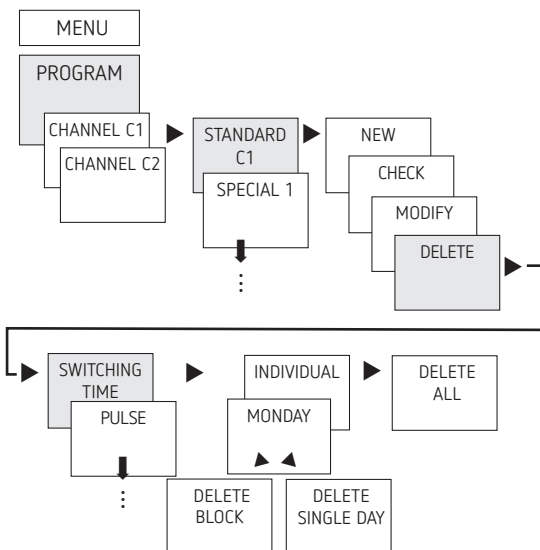

① You can either delete a block, i.e. a switching time copied for several days (e.g. Mon-Fri) or a single switching time

- Press MENU
- Select PROGRAM, confirm with OK
- Select CHANNEL C1 or C2, confirm with OK
- Select STANDARD, confirm with OK
- Select DELETE, confirm with OK
- Select SWITCHING TIME, confirm with OK
- INDIVIDUAL is displayed (with ► DELETE ALL), confirm with OK
- MONDAY is displayed, confirm with OK
- Select DELETE BLOCK, confirm with OK
- With ► DELETE MONDAY etc. individual days can also be deleted

Pulse programming

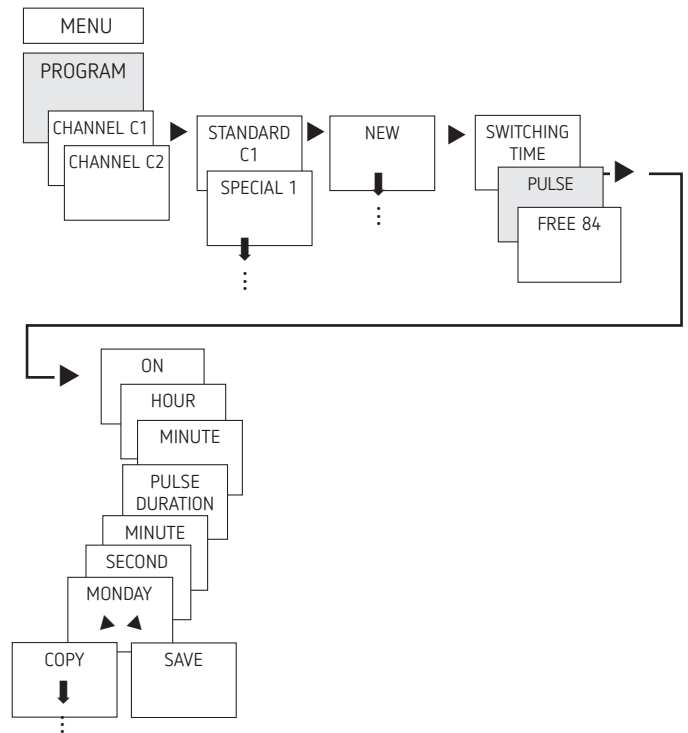

Example: Switch on pause signal on Monday at 8:05 for 5 sec

- Press MENU
- Select PROGRAM, confirm with OK
- Select CHANNEL C1 or C2, confirm with OK
- Select STANDARD, confirm with OK
- Select NEW, confirm with OK
- With ► select PULSE, confirm with OK
- Select ON, confirm with OK
- Use the + or – buttons to enter hour, minute, second (8:05) and confirm with OK
- Use the + or – buttons to enter the duration of the pulse in minutes and seconds (5 sec) and confirm with OK. MONDAY is displayed.
- Select day, confirm with OK
- Select COPY or SAVE
- To save press ► and confirm with OK
- To copy press OK

Cycle programming

In addition to turn-on and turn-off times (switching time) and short time pulses (pulse), cycle times (cycle) can also be programmed. The pulse duration (+ pulse pause) is limited to 17 hrs, 59 min, 59 sec

- ① Cycle times are cyclically repetitive time functions such as fan controls, urinal rinses, etc.

Example: Switch on water rinsing Monday from 8:00 to 20:30 every 15 min. for 20 s (8:00:00–8:00:20 On; 8:15:00–8:15:20 On; 8:30:00–8:30:20 On, etc.)

Cycle programming:

- Start cycle: Monday 8:00
- Pulse duration: 20 s
- Pause duration (pause): 14 min and 40 s
- End cycle: Monday 20:30

- ① Observe the maximum number of electrical switching cycles when using the cycle function.

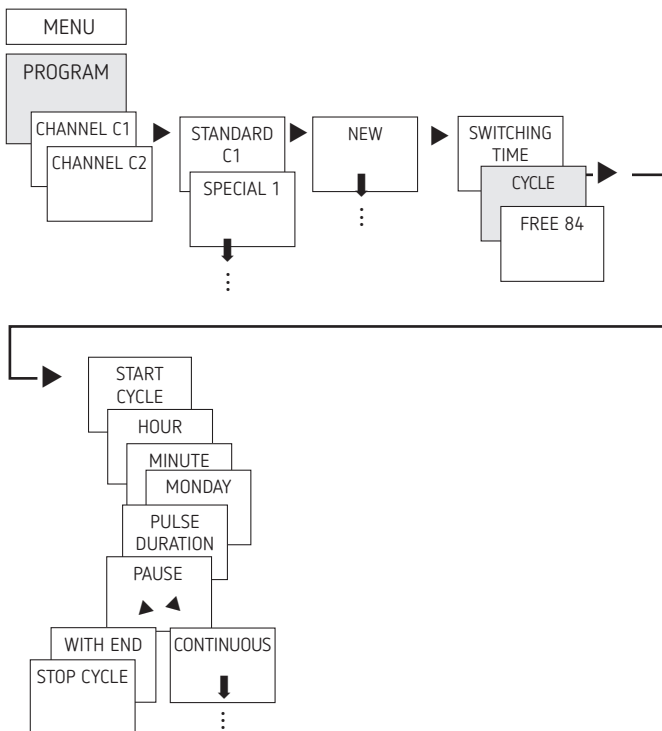

- Press MENU
- Select PROGRAM, confirm with OK
- Select CHANNEL C1 or C2, confirm with OK
- Select STANDARD, confirm with OK
- Select NEW, confirm with OK
- With ► select CYCLE, confirm with OK
- START CYCLE is displayed, confirm with OK
- Use the + or – buttons to enter hour, minute, day (8:00 Monday) and confirm with OK
- Enter PULSE DURATION (20 s), confirm with OK
- Enter pause duration PAUSE (14 min and 40 s), confirm with OK
- Select WITH END, confirm with OK
- STOP CYCLE is displayed, confirm with OK
- Enter end times of the cycle (20:30) and confirm with OK

Setting a special function

Two on/off switching pairs that are not specific to particular weekdays can be programmed and activated for the set date ranges.

- ① For the two-channel devices, the special programs can be set individually for each channel.

Special program 1

Set 2 turn-on and turn-off times individually based on the date ranges.

- Fixed date
- Fixed date each year
- Easter date
- Public holiday set (only via app or OBELISK)

Special program 2

Set switch-on based on the date ranges.

- Fixed date
- Fixed date each year
- Easter date
- Public holiday set (only via app or OBELISK)

Special program 3

Set switch-off based on the date ranges.

- Fixed date
- Fixed date each year
- Easter date
- Public holiday set (only via app or OBELISK)

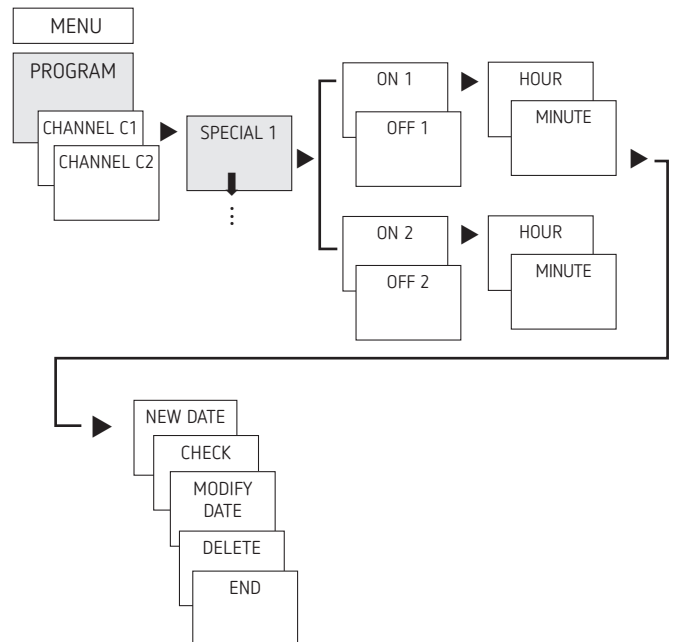

- Press MENU
- Select PROGRAM, confirm with OK
- Select CHANNEL C1 or C2, confirm with OK
- Select SPECIAL 1, confirm with OK
- ON 1 (for turn-on time) is displayed
- Set required turn-on time, confirm with OK
- OFF 1 (for turn-off time) is displayed
- Set required turn-off time, confirm with OK
- Repeat process for ON 2 and OFF 2

Setting holiday function

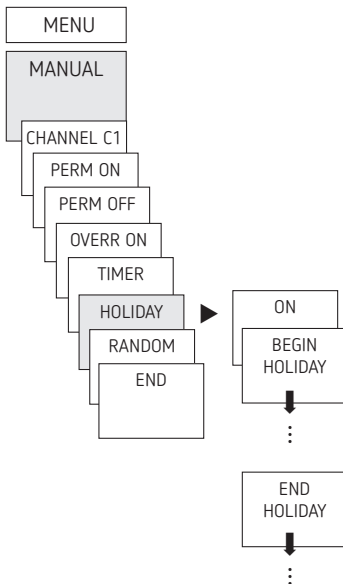

- Press MENU
- Select MANUAL, confirm with OK
- Select CHANNEL C1 or C2, confirm with OK
- Select HOLIDAY, confirm with OK
- Select ON, confirm with OK
- Select BEGIN HOLIDAY, confirm with OK
- Enter YEAR, MONTH, DAY, HOUR, confirm with OK
- Select END HOLIDAY, confirm with OK
- Enter YEAR, MONTH, DAY, HOUR, confirm with OK

Activating PIN code

The PIN code is set in OPTIONS via the menu.

- ① If you have forgotten your PIN, please call the Theben Hotline.
- ① Have the serial number ready.

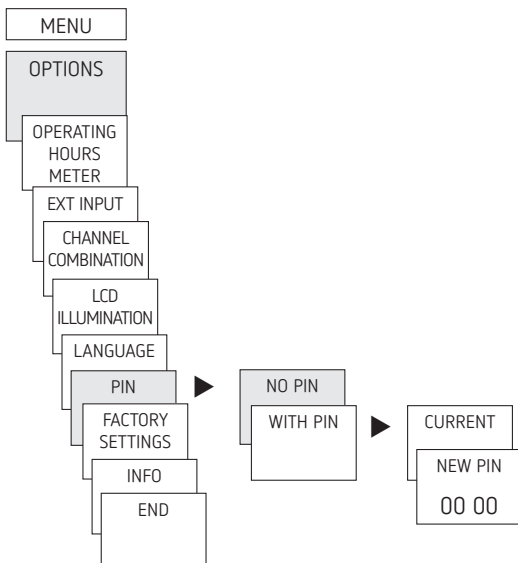

Time signal can be received with appropriate top3 RC antenna (only with TR 611 top3 RC)

- ① Refer to operating instructions 310336 when connecting a GPS antenna (9070610).
- ① Follow the advice in the top3 RC-DCF antenna operating instructions.
- ① Connection to the top3 RC-DCF antenna allows the time switch to be automatically synchronised via DCF signal.
- ① After connecting to the power supply or resetting, the automatic display appears as soon as the DCF transmission signal has been received.

Adjusting of time zones

After successful synchronisation, the time zone can be altered in the TIME / DATE menu option.

- In the TIME menu (display: MODIFY HOUR) correct the applicable local time (time zone).

DCF transmission signal reception:
Display: Day + Month + RC
(Radio Control)

No reception of the DCF transmission signal
Display: e.g. 24 11 07 ↑

No connection to antenna:
Display: e.g. 24 11 07

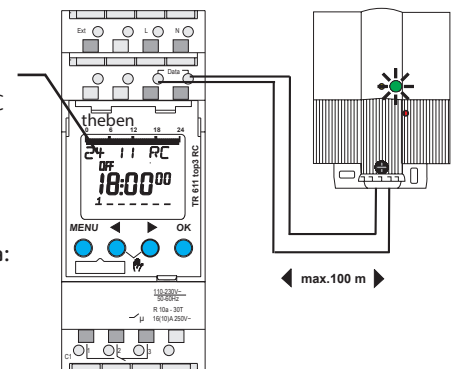

Setting manual control or permanent switching

Manual control or permanent switching can be set via the menu in MANUAL or (in the automatic display) by button combination (see picture).

- Manual control:
Reversing the channel status until the next automatic or programmed switch.
- Permanent switching:
As long as permanent switching (on or off) is activated, the programmed switching times are ineffective

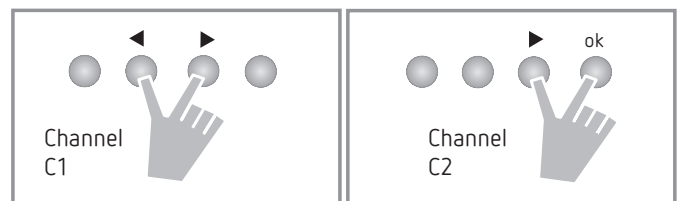

Activating manual control

- Briefly press both buttons simultaneously

Activating permanent switching

- Press both buttons simultaneously for 2 s

Cancelling manual control/permanent switching

- Press both buttons simultaneously

Setting an external input

For the channel, an EXT INPUT (see figure) can be set with different functions.

3 sub-menus can be selected: not active, button (function), switch (function)

- NOT ACTIVE: The external input has no function
- BUTTON: Manual (manual control), Timer (countdown timer) are selectable
- SWITCH: Permanent on, permanent off are selectable

① If a function is activated via an external button or switch, EXTERNAL is displayed.

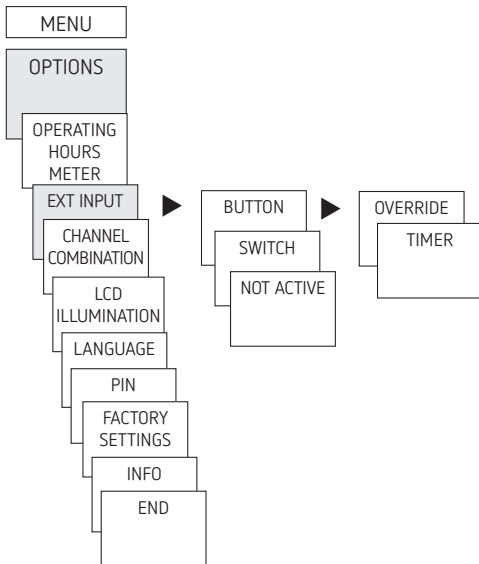

➤ Press MENU, with ► select EXT INPUT and follow the indications on the display

Setting channel lock (only for TR 622 top3)

There are situations where two channels must not be switched at the same time!

The channels can be interlocked in this case.

① The channel lock prevents both channels from switching on at the same time.

If a channel is already switched on, the second channel will not switch on until the first channel is switched off and a waiting time of 1 s has passed.

If both channels are switched on at the same time, channel 1 has priority.

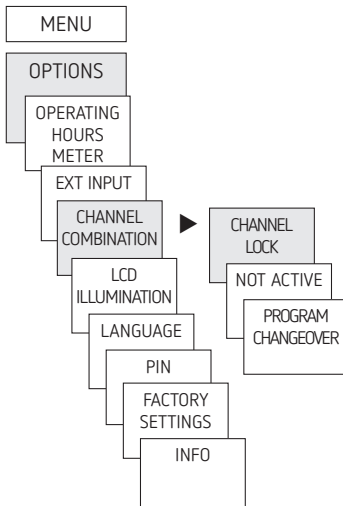

Channel combination

The channel combination reduces maintenance for wear to the lamps and also allows energy to be saved.

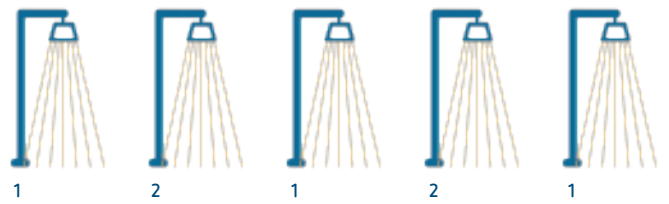

Astronomical switch-on at sunset

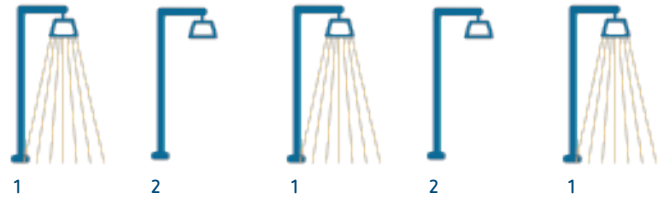

At a defined time, switch off the second channel to save energy and retain basic lighting.

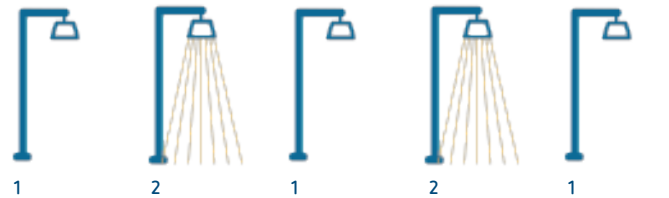

Each week/day, change the channel that is switched off to use the consumers evenly.

Hour counter

The operating hours of the channel (relay) are displayed and deleted in the OPTIONS menu. If the number of operating hours exceeds the value set in the Service menu, SERVICE will appear in the display.

Example: Replace a lamp after 5000 h.

➤ Delete operating hours or set a higher value in Service (e.g. 10,000 h)

Using Bluetooth OBELISK top3

All functions can also be transferred to the time switch using the Bluetooth OBELISK top3 memory card (9070130).

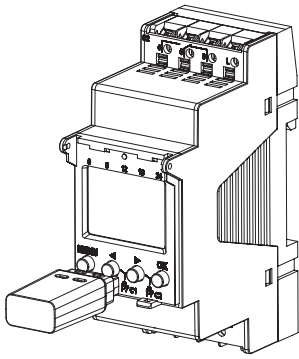

Copying OBELISK → TIME SWITCH

This copies the switching program and optionally all time switch settings (e.g. time format, etc.) from the memory card to the time switch.

Copying TIME SWITCH → OBELISK

This copies all switching programs and settings from the time switch to the memory card.

Starting OBELISK program

Takes over the switching times that are programmed on the memory card.

As soon as the memory card is removed, the switching times of the time switch are re-activated.

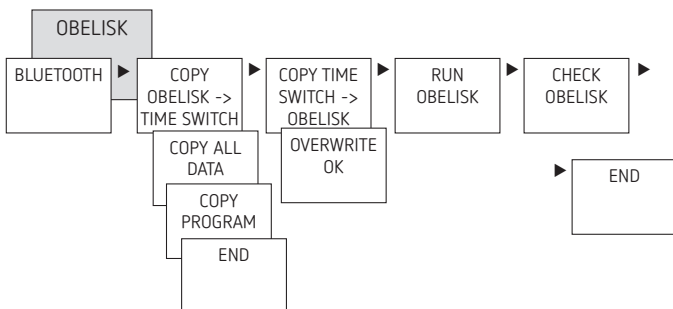



Connecting time switch, Bluetooth OBELISK top3 and smartphone (via app)

The devices in the top3 range can be programmed using an app (for Android, iOS) on a mobile end device. Communication takes place via Bluetooth OBELISK top3. Switching programs are transferred and direct switch commands are sent to the device.

- Download the OBELISK top3 app from the App Store or Google Play Store



- ⓘ Bluetooth connection only possible in automatic mode, not in manual mode like OPTIONS, etc.

- Open the app and activate using one of the 3 commands, by pressing "Download" , "Manual command"  or "Upload" 

→ Device/device list appears on the display.

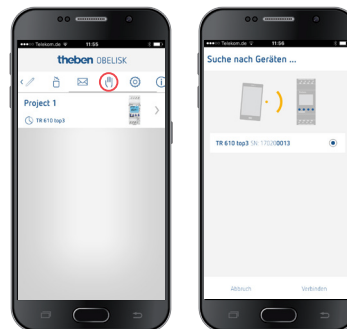

- Press "Connect"



- Press OK on the time switch
→ The display shows BLUETOOTH ACTIVE
- Press "Close" in the app within 30 s

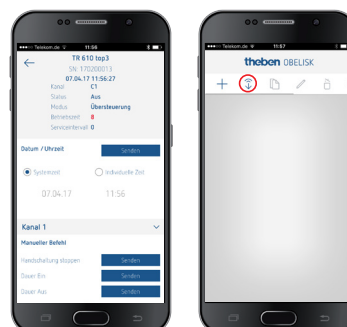

Now, for example, projects can be created and uploaded.

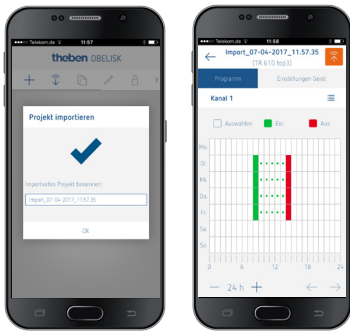

Resetting the time switch

- ▶ Press the 4 buttons simultaneously
 - You can now choose between RETAIN PROGRAMS and DELETE PROGRAMS

6. Technical data

Operating voltage:	230 V AC, +10% / -15% 110 - 230 V AC (6110330)
Frequency:	50-60 Hz
Standby (6110130, 6220130):	0.4 W
Standby (6110330):	0.75 W
Max. switching capacity:	16 A (at 250 V, $\cos \varphi = 1$)
Switching capacity:	10 A (at 250 V, $\cos \varphi = 0.6$)
Min. switching capacity:	10 mA/230 V AC 100 mA/24 V AC/DC
Switch output:	Switching of any external conductor is permitted
TR 611top3 (6110130):	Suitable for switching SELV (Safety Extra-Low Voltage)
Shortest switching time:	1 min
Switching accuracy:	To the second
Protection rating:	IP 20 in accordance with EN 60529
Protection class:	II in accordance with EN 60730-1 subject to designated installation
Software:	Class A
Operating temperature:	6110330: -25 °C ... +55 °C 6110130: -30 °C ... +60 °C 6220130: -30 °C ... +55 °C
Power reserve:	10 years at +20 °C (without Bluetooth OBELISK top3)
Time accuracy (typical):	± 0.25 s/day (25 °C)
Rated impulse voltage:	4 kV
Pollution degree:	2
Contact:	Changeover contact
Incandescent lamp load:	2600 W
Halogen lamp load:	2600 W
Fluorescent lamp load: uncorrected	2600 VA
series-corrected:	2600 VA
parallel-corrected:	1300 VA (130 µF)
Compact fluorescent lamps (EVG):	1100 W
LED lamps (< 2 W):	50 W
LED lamps (> 2 W):	600 W
Bluetooth OBELISK top3:	
- Protection rating:	IP 40
- Temperature:	-30 °C ... +55 °C
- Range:	15 m on open air test site

① The time switch display is only fully functional at temperatures from +5 °C ... +55 °C.

7. Contact

Theben AG
Hohenbergstr. 32
72401 Haigerloch
GERMANY
Phone +49 7474 692-0
Fax +49 7474 692-150

Hotline

Phone +49 7474 692-369
hotline@theben.de

Addresses, telephone numbers etc.
www.theben.de