

Quick Manual

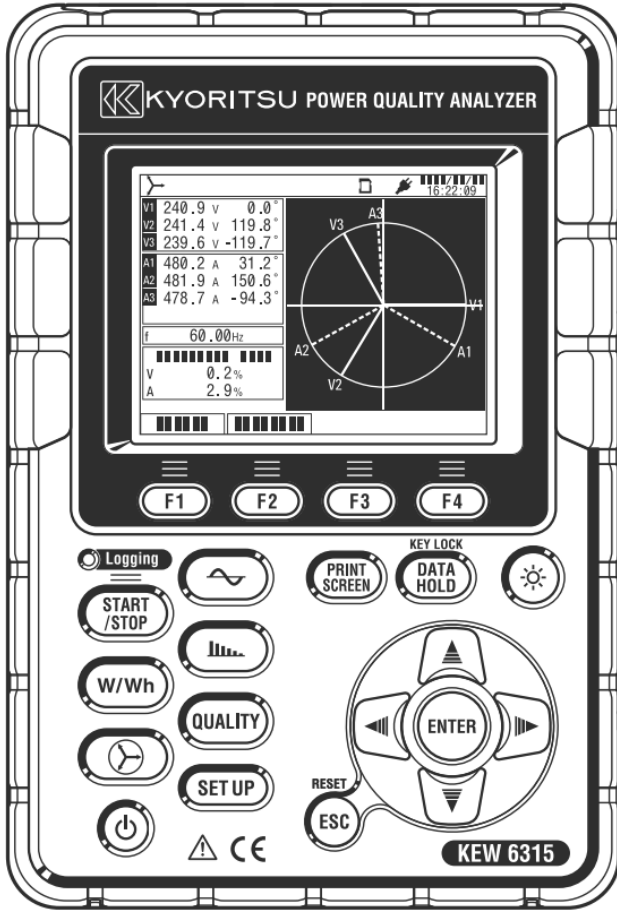

POWER QUALITY ANALYZER

KEW6315



**KYORITSU ELECTRICAL
INSTRUMENTS WORKS, LTD.**







- Preface

This Quick manual is a simplified version of the full instruction manual which can be found in the supplied CD-ROM. This manual is intended only as a handy reference guide and should only be used after having read the full instruction manual which contains full details on each function of this instrument and the items contained in the package.

- Safety Warning!

The instruction manual contains warnings and safety procedures which have to be observed to ensure safe operation of the instrument and maintain it in a safe condition. Thus, these operating instructions have to be read prior to using the instrument.

Content

1. Instrument Overview	2
2. Start/ Stop Recording 	5
3. Instrument Layout	13
4. Getting Started	17
5. Inst/ Integration/ Demand 	
Inst value : W	19
Integration value: Wh/ Demand	21
6. Vector 	25
7. Waveform 	26
8. Harmonics Analysis 	27
9. Power Quality 	
Event(Swell/ Dip/ Int/ Inrush current/ Transient)	30
Flicker	33
10. Setting 	35
11. SD Card/ Saved Data	38

The latest software can be downloaded from our homepage: www.kew-ltd.co.jp

1. Instrument Overview

Feature

This is a Clamp-type Power Quality Analyzer that can be used for various wiring systems. It can be used for simple measurements of instantaneous/ integration/ demand values, and also for analysis of harmonics and events related to power quality and for the simulation of power factor correction with capacitor banks. Moreover, it can display waveforms and vectors of voltage and current. Data can be saved either in the SD card or the internal memory, and can be transferred to PC via USB, or in real time via Bluetooth communication.

Safety construction

Designed to meet the international safety standard IEC 61010-1 CAT.IV 300V/ CAT.III 600V/ CAT.II 1000V.

Power quality analysis

KEW6315 is designed to meet the international standard IEC61000-4-30 Class S and can measure frequency and r.m.s. voltage with high accuracy, and also can analyze harmonics. Moreover, it can measure swell, dip, interruption, transient, inrush current and flicker all at once without a gap.

Power measurement

KEW6315 measures active/reactive/apparent power, electrical energy, power factor, r.m.s. current, phase angle and neutral current simultaneously.

Wiring configuration

KEW6315 supports: Single-phase 2-wire (4ch), Single-phase 3-wire (2ch), Three-phase 3-wire (2ch) and Three-phase 4-wire.

Demand measurement

Electricity consumption can be easily monitored so as not to exceed the target maximum demand values.

Waveform/ vector display

Voltage and current can be displayed by waveform or vector.

Saving data

KEW6315 is endowed with a logging function with the preset recording interval. Data can be saved by manual operation or by specifying date & time. Screen data can be saved by using the Print Screen function.

Dual power supply system

KEW6315 operates either with AC power supply or with batteries. Both dry-cell batteries (alkaline) and rechargeable batteries (Ni-MH) can be used. To charge the rechargeable battery, use the charger which is manufactured by the same company as the batteries. In the event of power interruption, while operating with AC power supply, power to the instrument is automatically restored by the batteries in the instrument.

Large display

TFT color display with large screen.

Light & compact design

Clamp sensor type, compact and light weight design.

Application

Data in the SD card or the internal memory can be saved in PC via USB. Analysis of the downloaded data and instrument settings are possible by using the special software "KEW Windows for KEW6315". Real-time communication is available via Bluetooth.

Input/ Output function

Analog signals from thermometers or light sensors can be measured simultaneously with electrical power data via 2 analog inputs (DC voltage); when any events related to power quality occur, signals can be transmitted to alarm devices via one digital output.

Functional overview

Start/ Stop

Choose either "Quick start guide" or "Start now" to start recording. Can do simple and fast start-up setting by selecting "Quick start guide".

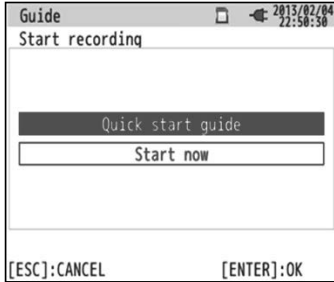

See "2. Start/Stop Recording" for further details.

Inst/ Integration/ Demand

Display the avg/ max/ min instantaneous values of current/ voltage/ active power/ apparent power/ reactive power. Integration values also can be viewed by switching screens. Moreover, demand values with the preset target value can also be checked.

W/Wh			2013/06/05 13:42:06		
	1ch	2ch	3ch		
V :	596.7	445.6	499.1	V	
A :	49.9	39.6	44.8	A	
P :	29.78	17.68	26.78	kW	
Q :	20.03	10.65	20.39	kvar	
S :	29.78	17.68	26.78	kVA	
PF :	0.798	0.785	0.793		
P :	91.95	kW	f :	60.00	Hz
Q :	57.23	kvar			Avg
S :	91.95	kVA			Max
PF :	0.809	A4 :	39.6	A	Min
DC1 :	0	mV	DC2 :	-0	mV
Wh	Zoom	Trend	Customize	02:14	730min

See "5. Inst/ Integration/ Demand" for further details.

Vector and Wiring check

Vectors of voltage and current per CH are displayed on a graph. KEW6315 will perform wiring check.

See "6. Vector" for further details.

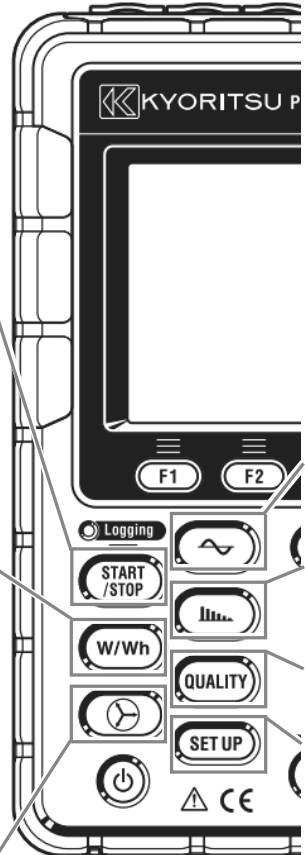
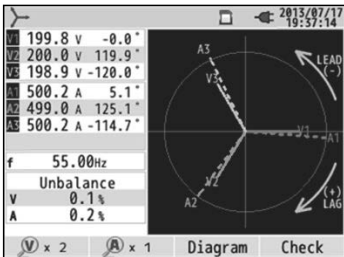

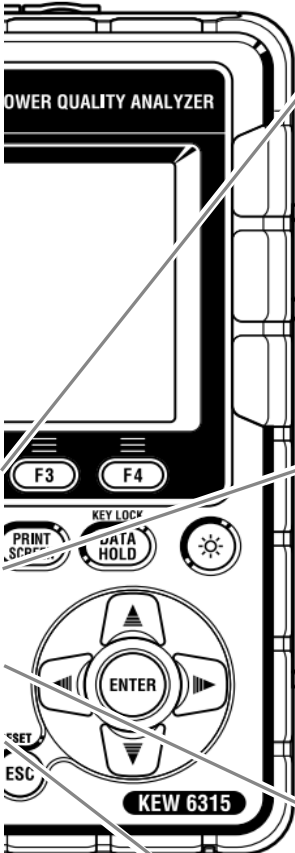

Waveform

Waveforms of voltage and current per CH are displayed on a graph.

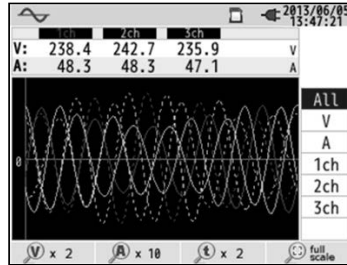

See "7. Waveform" for further details.

Harmonic Analysis

Harmonic components of voltage and current per CH are displayed on a graph.

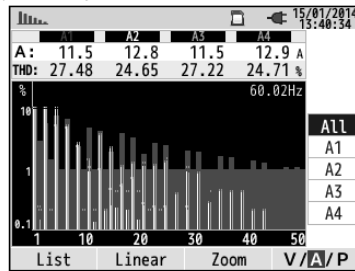

See "8. Harmonic Analysis" for further details.

Setting (SET UP)

Make settings for KEW6315 and measurements.

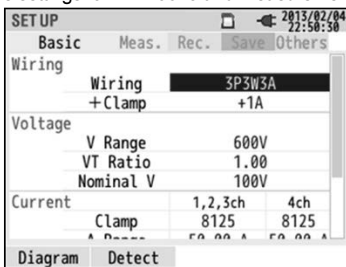

See "10. Setting" for further details.

Power Quality (QUALITY) event

Display voltage swell, dip, int, transient, inrush current and flicker.

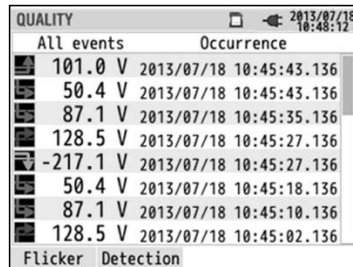

See "9. Power Quality" for further details.

2. Start/ Stop Recording



Steps for measurement

Can start recordings with simple steps by selecting “Quick start guide”.

Ensure your safety and do the appropriate preparations before starting measurements.

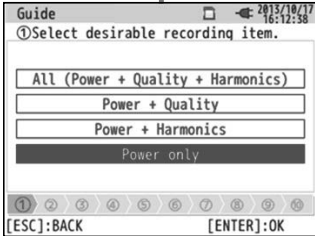

(1) Select the item you want to record.

* The number of selected items will have effect on file size and also on max recording time.

See P.40.

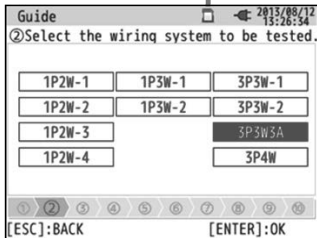

(2) Select the wiring system to be measured.

* Select a proper wiring system for accurate measurements.

See P.7.

(3) Connect to the circuit to be tested.

* Read and follow the safety precautions described in the instruction manual.

See P.17.

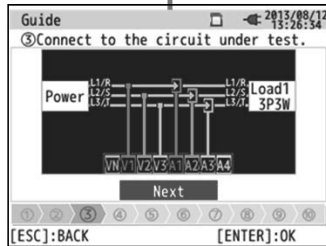

(4)(5) Check the Test environment.

* Self-diagnosis, wiring check and detection of connected sensors will be performed in this test.

* It is recommended to do this test for ensuring the testing conditions are correct.

See P.8.

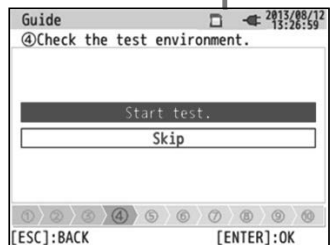



(6) Select a recording interval.

* Selecting a short interval gets the file size large. In this case, a long period recording cannot be performed.

See P.38.



(7)(8)(9) Select a recording method.

See P.11.

(10) Prepared. Recording will start.

The mark "REC" will appear on the screen when the recording starts and the green LED (status indicator) lights up.

If you want to terminate the recording, press the "START/STOP" button and follow the instructions displayed on the screen.

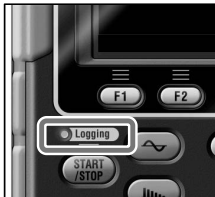
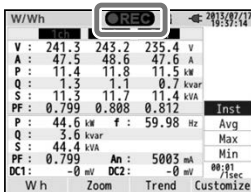
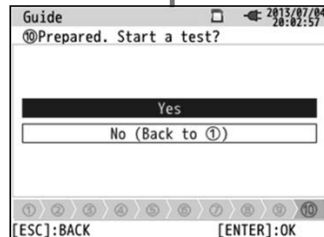

(2) Wiring system

Any of the followings can be selected.

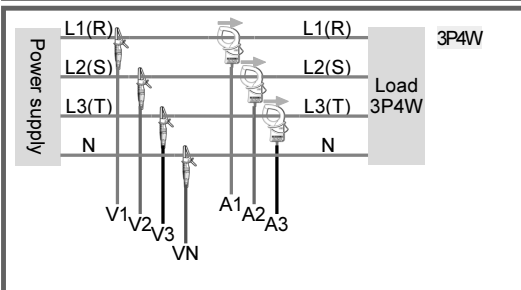
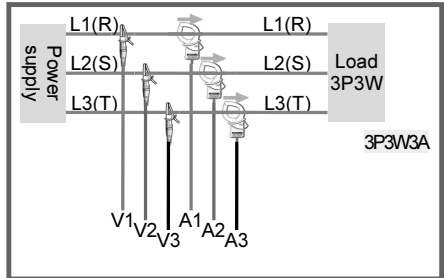
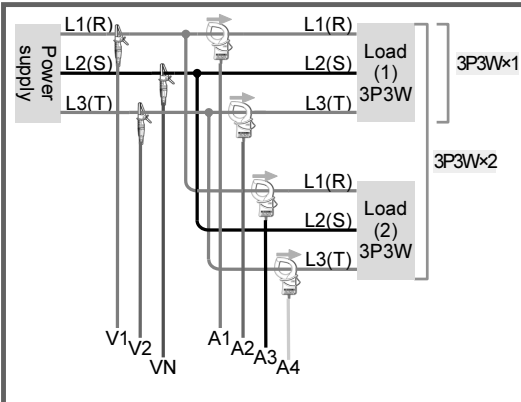
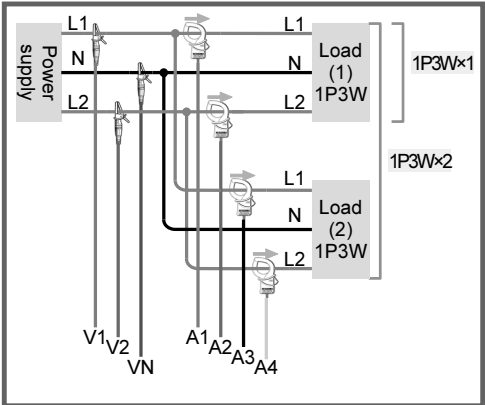
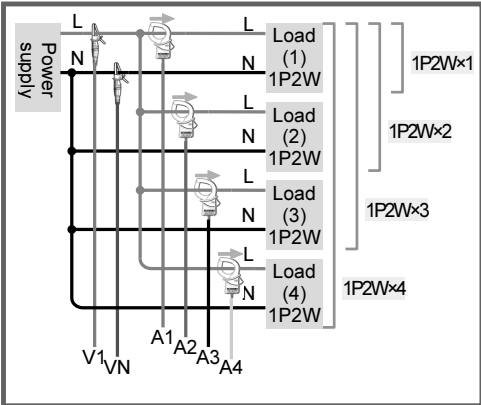

Orientation of Clamp sensor

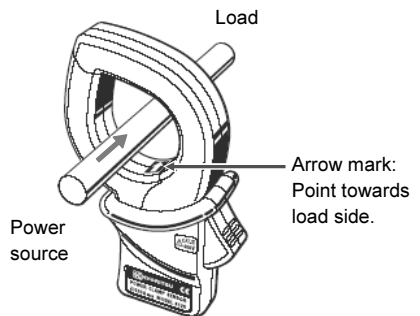

Reverse clamping switches the symbols (+/-) for active power (P).

NOTE: Types of the current sensors used for measurements should be the same.

(4)/ (5) Test Environment Check

Test environment check

Select "**Start test**" and press the "ENTER" button to start the test. The test result will be displayed on the screen.

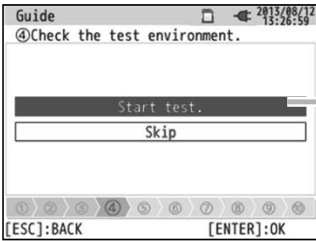

Select and press the "ENTER" on "OK"/"NG" to see the details.

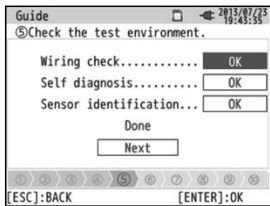
**Wiring check**

Test results of each item will be displayed.

* NG result may be given, even if the wiring is correct, at the measurement site under bad power factors.

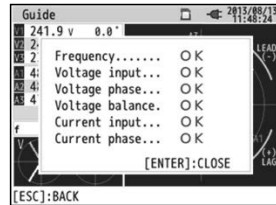
**Self-diagnosis**

Operating condition of the instrument system will be checked and the result will be displayed.

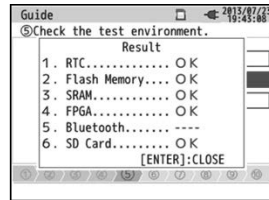
**Sensor detection**

The connected sensors are automatically detected and their max Ranges will be set.

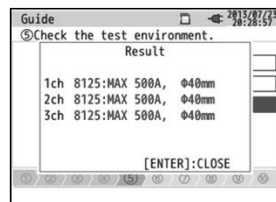

NG judgment

Wiring check

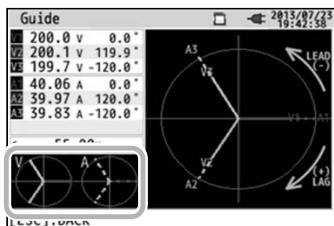

Close the result display. Then, the blinking vectors and the values of NG items will be displayed. If all the results are OK, the ideal vector diagram will be displayed at the lower left corner.

Criteria of judgment and cause

Check	Criteria of Judgment	Causes
Frequency	Frequency of V1 is within 40 - 70Hz.	- Voltage clip is firmly connected to the DUT? - Measuring too high harmonic components?
AC voltage input	AC voltage input is 10% or more of (Nominal voltage x VT).	- Voltage clip is firmly connected to the DUT? - Voltage test lead is firmly connected to the AC voltage input terminal on the instrument?
Voltage balance	AC voltage input is within $\pm 20\%$ of reference voltage (V1). * (not checked in single-phase wiring)	- Settings are matched with the wiring system under test? - Voltage clip is firmly connected to the DUT? - Voltage test lead is firmly connected to the AC voltage input terminal on the instrument?
Voltage phase	Phase of AC voltage input is within $\pm 10^\circ$ of reference value (proper vector).	- Voltage test leads are properly connected? (Connected to proper channels?)
Current input	Current input is 5% or more and 110% or less of (Current Range x CT).	- Clamp sensors are firmly connected to the Power input terminals on the instrument? - Setting for Current Range is appropriate for input levels?
Current phase	- Power factor (PF, absolute value) at each CH is 0.5 or more. - Active power (P) at each CH is positive value.	- Arrow mark on the Clamp sensor and the orientation of flowing current coincide with each other? (Power supply to Load) - Clamp sensors are connected properly?

Self-diagnosis

If "NG" judgment is given frequently, there might be something wrong with the instrument. Stop using the instrument and refer to "*Troubleshooting*" in the instruction manual.

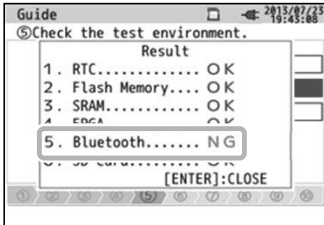

Sensor detection

If the detection result is NG, each sensor type will be displayed in red.

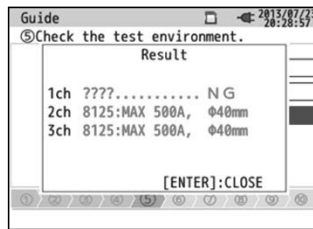
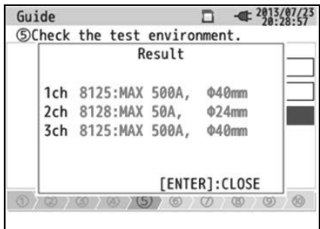

Criteria of judgment and cause

Causes Check	Causes
Type of current sensor	- Types of the connected current sensors are harmonized? Types of the current sensors used for measurements should be the same.
??? (cause unknown)	- Current sensors are firmly connected to the instrument? - If any failures are in doubt: <p>Exchange the connections of the sensors and test again.</p> <p>Connect the current sensor, for which "NG" is given, to the CH on which another sensor is properly detected.</p> <p>If the result "NG" is given for the same CH, a defect of the instrument is suspected. A defect of sensor is suspected if "NG" is given for the same sensor connected to another CH.</p> <p>Stop using the instrument and the sensor, if any defects are in doubt, and refer to "<i>Troubleshooting</i>" in the instruction manual.</p>

(8)/ (9) Setting for recording method

The following explains how to set recording start date and time.

(8) Specify the recording start date and time.

During the selected period, KEW6315 performs recording at the preset intervals.

Example: When the date & time are specified as above, the recording period will be as follows.

From 8:00 on August 2, 2013 to 18:00 on August 7, 2013,



(9) Specify the recording time period.

KEW6315 performs recording during the selected time period at the preset intervals, and repeats recording processes during the preset time span.

Example: When the time period is specified as above, the recording period is as follows. KEW6315 does not record data between 18:00 and 8:00.

- (i) 8:00 to 18:00 on August 1, 2013,
- (ii) 8:00 to 18:00 on August 2, 2013,
- (iii) 8:00 to 18:00 on August 3, 2013,
- (iv) 8:00 to 18:00 on August 4, 2013,
- (v) 8:00 to 18:00 on August 5, 2013,
- (vi) 8:00 to 18:00 on August 6, 2013,
- (vii) 8:00 to 18:00 on August 7, 2013, and
- (viii) 8:00 to 18:00 on August 8, 2013.

Switching of displayed parameters

Basically, the **Cursor Key**  is used for selecting an item, the **ENTER Key**  is for confirming the selection, and the **ESC Key**  is for canceling the alternation. Taking the procedures in “Quick Start Guide” as an example, Key operations are explained as follows.



Press the **Cursor Key** to move the **blue highlight**, showing the item is being selected, over the items in blue letters. In the screen at the left is the Recording start screen. Press the **Cursor Key** and move the blue highlight on the desirable recording method, and press the **ENTER Key** to confirm the selection. To quit the start guide, press the **ESC Key**.

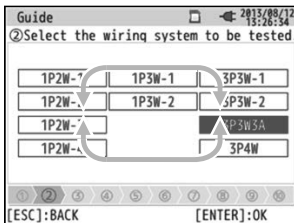

If the display of the **selectable items** is similar to the one shown to the left, then the up, down, right and left **Cursor Keys** can be used. Use the **Cursor Keys** to select the proper wiring system and press the **ENTER Key** to confirm the selection. To return to the previous screen and cancel the changes, press the **ESC Key**.

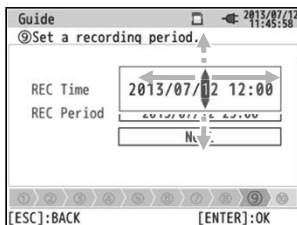

To alter the numbers such as **Date/ Time**, move the blue highlight over digits with the right and left **Cursor Keys** and alter the number with the up and down **Cursor Keys**. In the screen to the left, the tenth place of the day is being selected. The number can be increased or decreased by 1 with the up/ down **Cursor Keys**. Press the **ENTER Key** to confirm the selection, or press the **ESC Key** to return to the previous screen and cancel the changes.

3. Instrument Layout

Front View

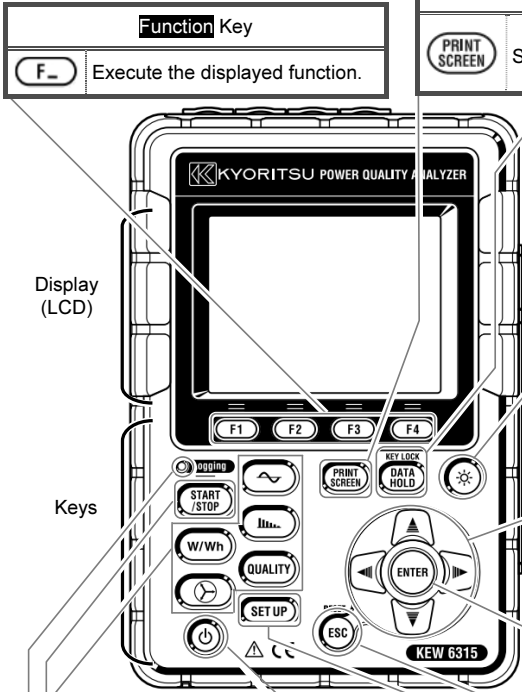

Display (LCD)

Keys

Function Key

F Execute the displayed function.

PRINT SCREEN Key

PRINT SCREEN Save the displayed screen as BMP file.

DATA HOLD Key/ KEY LOCK Key

DATA HOLD Hold the readings on the display.
* Measurement continues while the readings are being held on the display.

KEY LOCK Long press (at least 2 sec) disables all Keys to prevent operational errors. Another long press (at least 2 sec) is required to restore the disabled Keys.

LCD Key

LCD Turn on/ off the backlight.
Long press (at least 2 sec) changes the brightness and contrast.

Cursor Key

Cursor Select items or switch displays.

ENTER Key

ENTER Confirm the entries.

ESC Key/ RESET Key

ESC Cancel setting changes and return to the previous settings.

START/ STOP Key

START /STOP Start/ stop measurement.

Power Key

Power Power on/ off.

Status LED

Green	Light up: Recording& measuring Blink: Stand-by
Red	Blink: Backlight is off.

SETUP Key

SETUP Change and confirm: Basic, Measurement, Recording and other settings, and also edit the saved data.

Menu Key

W/Wh	W/Wh	View inst, integration and demand values.	Harmonic Analysis	View harmonic voltage, current and power energy.
Vector	Vector	View phases.	QUALITY	View the detailed info about: swell, dip, int, transient, inrush current and flicker.
Waveform	Waveform	View voltage/ current waveforms.		

Connector

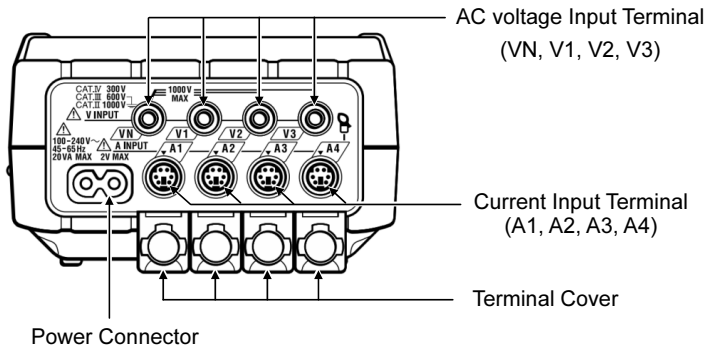



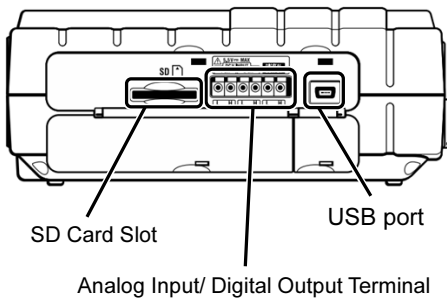



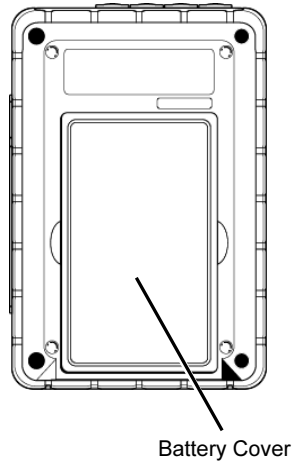









Side face



Battery case



Icons on the LCD

Icon	Status
	KEW6315 is operating with battery. This icon varies in 4 steps according to the battery power condition.
	KEW6315 is operating with AC power.
	Holding the display update.
	Keys are locked.
	Buzzer is off.
	SD card is set and available.
	Recording the data on the SD card.
	Available free space in the SD card is not enough.
	Failed to access to the SD card.
	Internal memory is available. * This icon is displayed when a measurement starts without SD card.
	Recording the data in the internal memory.
	Available free space in the internal memory is not enough.
	Stand-by mode
	Recording the measured data.
	Capacity of recording media is full.
	USB is available.
	Bluetooth is available.

Symbols on the LCD

Symbols displayed on the LCD					
V ^{*1}	Phase voltage	VL ^{*1}	Line voltage	A	Current
P	Active + consumption power - regenerating	Q	Reactive + lagging power - leading	S	Apparent power
PF	Power + lagging factor - leading	f	Frequency		
DC1	Analog input voltage at 1ch	DC2	Analog input voltage at 2ch		
An ^{*2}	Neutral current	PA ^{*3}	Phase + lagging angle - leading	C ^{*3}	Capacitance calculation
WP+	Active power energy (consumption)	WS+	Apparent power energy (consumption)	WQi+	Reactive power energy (lagging)
WP-	Active power energy (regenerating)	WS-	Apparent power energy (regenerating)	WQc+	Reactive power energy (leading)
THD	Voltage/ Current total distortion factor				
Pst (1min)	Voltage flicker (1 min)	Pst	Short term voltage flicker	Plt	Long term voltage flicker

^{*1} W screen: Displays of V and VL can be “customized” when “3P4W” is selected.

^{*2} W screen: “An” is displayed only when “3P4W” is selected.

^{*3} W screen: Displays of PA and C can be “customized”.

Backlight and Contrast Adjustment

Hold down the “” **LCD** Key at least 2 sec to show the sliding bar to adjust the backlight brightness and display contrast. Use the **Cursor** Key to slide the cursor on the bar for the adjustment. Press the **ENTER** Key and exit from the adjustment mode. Press the **ESC** or **LCD** Key again to cancel the adjustment and exit from the adjustment mode.

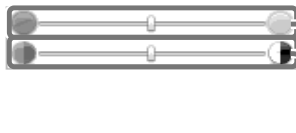
**Brightness adjustment**

Backlight brightness can be changed by 11 levels.

Contrast adjustment

Contrast can be changed by 11 levels.

4. Getting Started





Power supply

KEW6315 operates with either an AC power supply or batteries. Capable of performing measurements in the event of AC power interruption, power to the instrument is automatically restored by the batteries installed in the instrument. AA size alkaline battery (LR6) and AA size rechargeable battery (Ni-MH) can be both used. To charge the rechargeable battery, use the charger which is manufactured by the same company as the batteries. KEW6315 cannot charge batteries.

If an AC supply is interrupted and the batteries have not been inserted, the instrument goes off and all data may be lost.

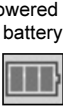
Battery Mark on the LCD/ Battery level

Power supply icon changes as follows, and the battery icon varies according to the battery condition.

Power supply icon	Powered by AC	
	Powered by battery	
Battery level	4-level	
		<p>Possible continuous measurement hours:</p> <ul style="list-style-type: none"> - approx 3 hours with size AA alkaline batteries, and - approx 4.5 hours with size AA Ni-MH (1900mA/h) batteries. <p>* These are ref. values with LCD turned off.</p>
		<p>Instrument works normally.</p> <p>* Voltage of full-charged Ni-MH battery is lower than the one of the full-charged alkaline battery, so the level indicator may not be the same as the one shown above even after fully charged.</p>
		<p>Measurement continues, but data save is ceased. (Further data will not be saved, but the data measured before the battery level drops to the lowest level are saved.)</p>

How to install batteries:

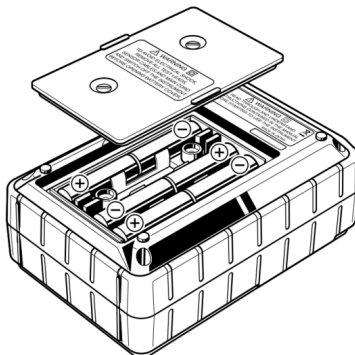

Install batteries in correct polarity as marked inside.

Battery power is consumed even if the instrument is being off. Remove all the batteries if the instrument is to be stored and will not be in use for a long period.

Cord Connection

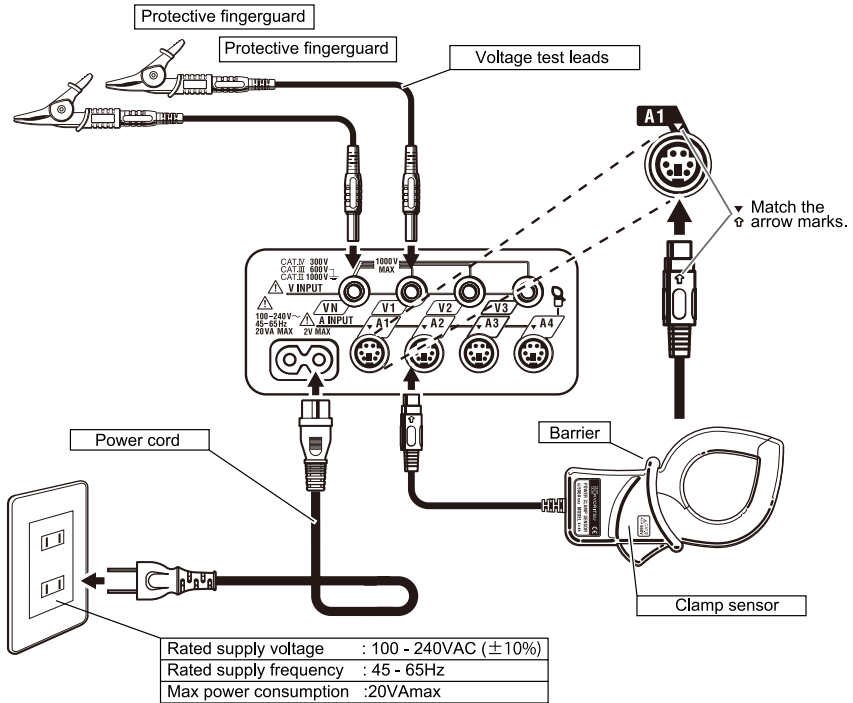

Protective fingerguard / Barrier

It is a part providing protection against electrical shock and ensuring the minimum required air and creepage distances.

*When the instrument and the test lead are combined and used together, whichever lower category either of them belongs to will be applied.

Start-up Screen

Model name and software version will be displayed upon powering on the instrument. Stop using the instrument if it does not get started properly, and refer to the “*Trouble-shooting*” in the instruction manual.



5. Inst/ Integration/ Demand values

W/Wh Switching screens

Press the **F1** button to toggle the screens.

W (Inst value)

W/Wh		2013/06/05 13:42:06
V :	596.7	445.6
A :	49.9	39.6
P :	29.78	17.68
Q :	28.03	10.65
S :	29.78	17.68
PF :	0.798	0.785
P :	91.95	kw
Q :	57.23	kvar
S :	91.95	kVA
PF :	0.809	
DC1 :	0 mV	DC2 : -0 mV
W h	Zoom	Trend

Wh (Integration value)

W/Wh		2013/07/04 20:54:49
Elapsed time 0000:00:00		
Active	WP+ :	0.00000 Wh
	WP- :	0.00000 Wh
Apparent	WS+ :	0.00000 VAh
	WS- :	0.00000 VAh
Reactive	WQi+ :	0.00000 varh
	WQi- :	0.00000 varh
DEMAND		

Demand

W/Wh		2013/02/10 01:57:46
Time left 00:30:00		
DEM Target	100.0 kW	
DEM Guess	0.000 kW	
DEM Present	0.000 kW	
DEM Max	----- kW	
W		



Inst value: "W"

Switching the items to be displayed

Use the right and left **Cursor** Keys to switch the displayed systems and the up and down **Cursor** Keys to switch the avg, max and min inst values.

Measured values
per CH

Sum of measured
values (all CHs)

W/Wh		2013/06/05 13:42:06
1ch		
V :	596.8	V
A :	50.4	A
P :	30.08	kW
Q :	26.13	kVA
S :	30.08	kVA
PF :	0.797	
P :	93.09	kw
Q :	84.94	kvar
S :	93.09	kVA
PF :	0.802	
DC1 :	-0 mV	DC2 : -0 mV
W h	Zoom	Trend

LOAD
1 2 3 4
Inst
Avg
Max
Min

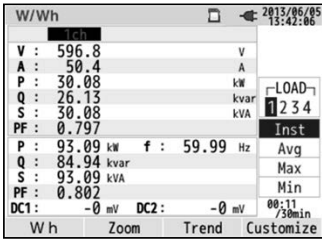

F2 F3 F4

Customize
Select and change the items to be displayed.

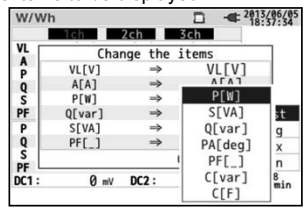
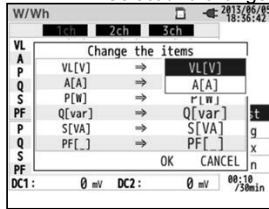

Trend

Changes of measured values are displayed on a graph.

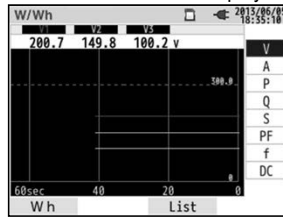

F3

Zoom

Zoom and display the selected items.

4-split

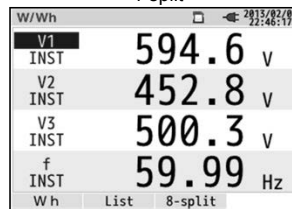

8-split

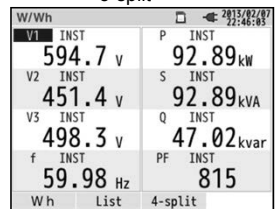

F2 F3

F3

Integration value: "Wh"

Switching the measurement items

Select the proper system with the right and left **Cursor** Keys and the CH with the up and down **Cursor** Keys.

W/Wh			2013/02/07 22:55:00
Elapsed time 00000:00:00			
Active	WP+ :	0.00000 Wh	
	WP- :	0.00000 Wh	
Apparent	WS+ :	0.00000 VAh	
	WS- :	0.00000 VAh	
Reactive	WQi+ :	0.00000 var	
	WQc+ :	0.00000 var	
DEMAND			

LOAD
1 Σ
Σ
1ch
2ch

Σ: sum of the all measured values

Σ: sum of measured values per CH

Demand

Switching the measurement items

Switch and select the items with the up and down **Cursor** Keys.

W/Wh			2013/06/07 09:45:53
Time left 00:28:53			
DEM Target	60.00	kW	
DEM Guess	16.65	kW	
DEM Present	0.620	kW	
DEM Max	0.620	kW	
			2013/06/07 09:45:52
W			

Meas.
[Line Graph]
[Bar Chart]

Parameters displayed when selecting "Meas." on the right row.

Time left

Count down the time set by: [SETUP] → [Measurement] → [Demand] → [Measurement].

DEM Target

Set the value by: [SETUP] → [Measurement] → [Demand] → [Target].

DEM Guess

Estimate and display the demand value that would be when this demand interval ends.

Present value x demand interval

Elapsed time from the start of the measurement



DEM Present

Demand value (average power) within a demand interval.

(Integration values of "WP+"
from the start of measurement) x 1 hour
Demand interval

DEM Max with recorded date

Max demand recorded in a measuring period is displayed. Displayed value will be refreshed if any higher demands are detected.

W/Wh			2013/06/07 09:45:53
Time left	00:28:53		
DEM Target	60.00	kW	Meas.
DEM Guess	16.65	kW	
DEM Present	0.620	kW	
DEM Max	0.620	kW	
2013/06/07 09:45:52			
W			

Parameters displayed when selecting “” (Change in specific period) on the right row.

Time left

Count down the time set by: [SETUP] → [Measurement] → [Demand] → [Measurement].

DEM P

Load factor: percentage of the present value against the target value. $\frac{\text{Present value}}{\text{Target value}}$

DEM G

Percentage of the predicted value against the target value. $\frac{\text{Predicted value}}{\text{Target value}}$

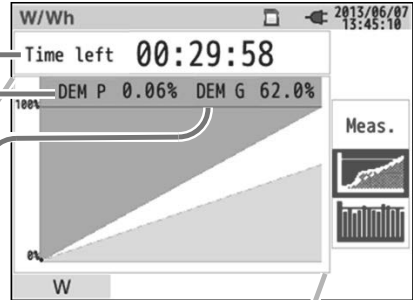

Audible warning warns when the predicted value exceeds the target value.

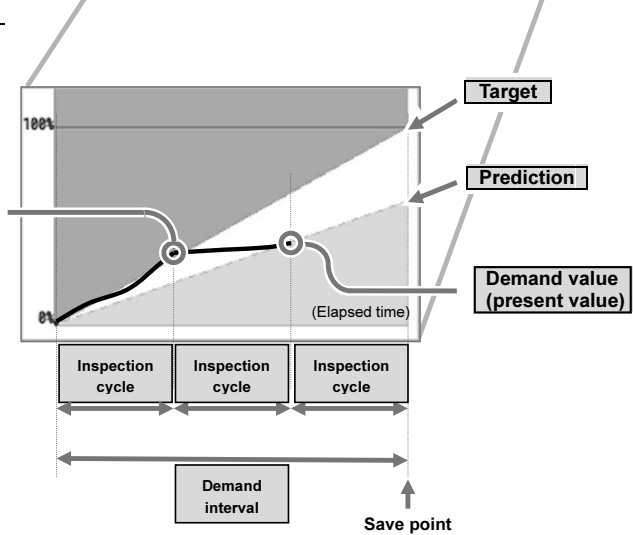

Parameters displayed when selecting “  ” (Demand change) on the right row.

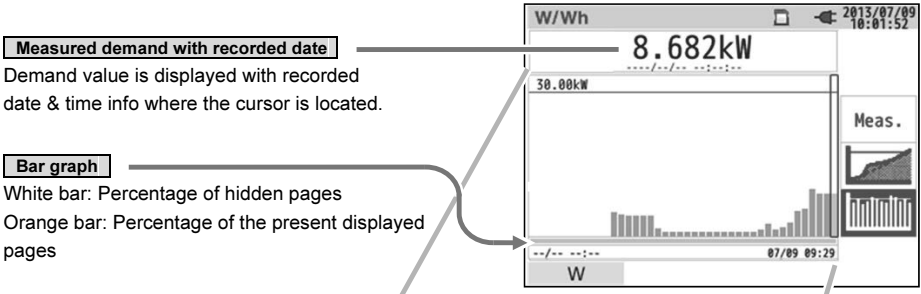

Measured demand with recorded date
Demand value is displayed with recorded date & time info where the cursor is located.

Bar graph
White bar: Percentage of hidden pages
Orange bar: Percentage of the present displayed pages

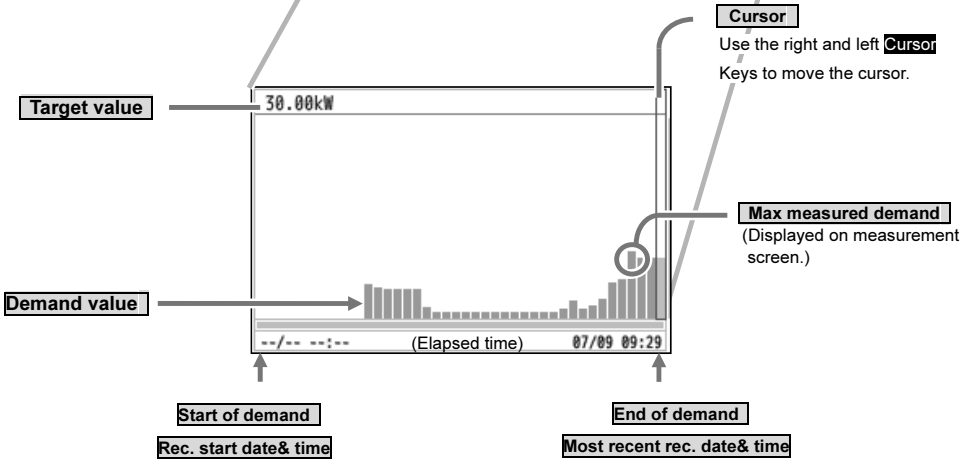

6. Vector

 Switching screens

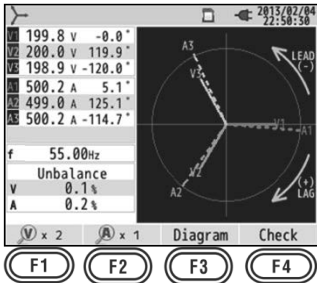

Wiring diagram

Diagram of the selected wiring is displayed.



Wiring check

Checked results will be displayed.

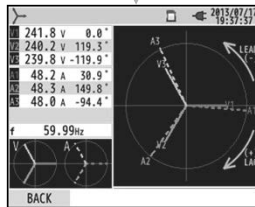
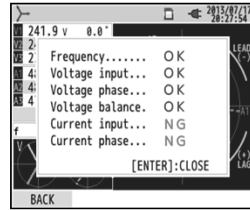

F1

F1 : toggle the line lengths of voltage vector.
→ 1 → 2 → 5 → 10 *time(s)

F2 : toggle the line lengths of current vector.
→ 1 → 2 → 5 → 10 *time(s)

7. Waveform



Switching displayed items

Select the items with up and down **Cursor** Keys and check for the waveforms.

Measured values
per CH

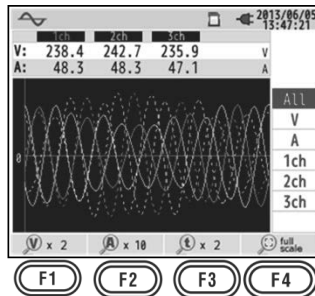
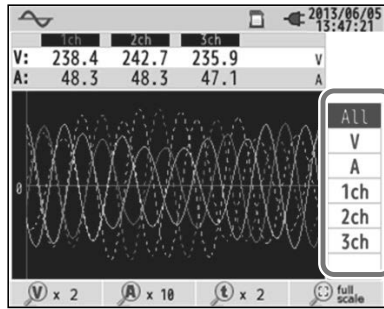

F1 : toggle the magnifications of voltage waveform (vertical).
 → 0.1 → 0.5 → 1 → 2 → 5 → 10 → *time(s)

F2 : toggle the magnifications of current waveform (vertical).
 → 0.1 → 0.5 → 1 → 2 → 5 → 10 → *time(s)

F3 : toggle the magnifications of time axis (horizontal).
 → 1 → 2 → 5 → 10 → *time(s)

F4 Restore all the changed magnification settings and automatically select the appropriate magnification.

8. Harmonics Analysis

 Switching displayed items

Graph

Use the up and down **Cursor** Keys to toggle the CHs for checking each harmonic.

Measured values
per CH

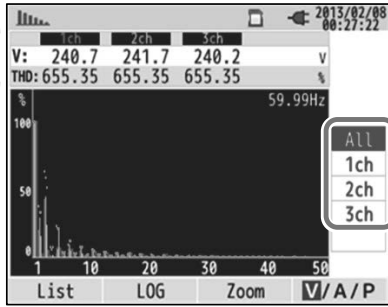

List

Use the up and down **Cursor** Keys to scroll the displayed degree of harmonics.

Measured values
per CH

V	V1	V2	V3
1	100.0	100.0	100.0
2	16.2	10.5	3.6
3	54.7	29.8	48.8
4	0.7	3.7	2.4
5	11.2	6.5	3.7
6	2.1	4.7	0.6
7	6.0	1.5	8.9
8	0.4	1.5	0.9
9	7.9	4.3	4.8
10	1.0	0.3	1.0

Graph DEG V/A/P

Voltage, Linear, Overall display

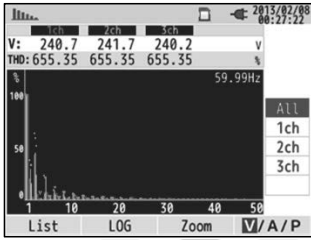

Current



Power

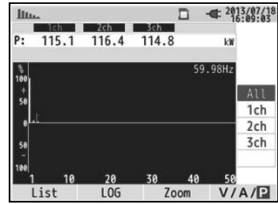

F1 F2 F3 F4

F4

F4

List, Rate of content

V	V1	V2	V3	%
1	100.0	100.0	100.0	%
2	16.2	10.5	5.6	%
3	54.7	29.8	48.8	%
4	0.7	3.7	2.4	%
5	11.2	6.5	3.7	%
6	2.1	4.7	0.6	%
7	6.0	1.5	8.9	%
8	0.4	1.5	0.9	%
9	7.9	4.3	4.8	%
10	1.0	0.3	1.0	%

F1 F2 F4

Logarithm

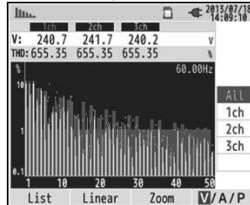

F2

Zoom

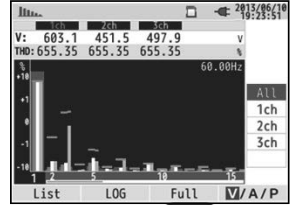

F3

Phase angle

V	V1	V2	V3	deg
1	0.0	118.2	-119.3	deg
2	10.8	121.0	-119.5	deg
3	3.5	118.9	-119.6	deg
4	-2.6	119.1	-119.2	deg
5	8.7	121.8	-119.0	deg
6	-3.7	119.5	-119.8	deg
7	-2.1	119.9	-119.2	deg
8	4.3	119.4	-119.2	deg
9	-9.5	119.1	-119.1	deg
10	3.7	120.8	-119.5	deg

F2

RMS value

V	V1	V2	V3	v
1	599.5	455.6	505.9	v
2	25.8	50.7	134.7	v
3	107.6	33.4	91.1	v
4	19.7	9.1	8.0	v
5	39.8	44.1	36.6	v
6	3.7	4.8	5.9	v
7	7.3	12.6	8.6	v
8	21.0	13.6	3.8	v
9	17.3	10.0	28.0	v
10	8.8	8.2	4.4	v

F2

Current

A	A1	A2	A3	A
1	481.4	481.9	478.5	A
2	69.5	137.0	89.3	A
3	213.2	57.3	70.6	A
4	6.0	4.4	9.9	A
5	77.1	94.6	15.9	A
6	24.7	12.1	27.3	A
7	33.3	48.2	47.7	A
8	16.1	5.4	4.2	A
9	26.5	8.8	41.8	A
10	1.4	2.0	5.5	A

F4

Power

P	P1	P2	P3	P
1	115.4	115.6	115.3	356.1kW
2	0.8	0.5	5.6	7.2kW
3	24.0	1.6	20.8	47.0kW
4	0.2	0.3	0.2	0.8kW
5	1.0	0.1	2.6	3.8kW
6	0.0	0.0	0.0	0.1kW
7	0.2	1.0	0.0	1.3kW
8	0.0	0.0	0.0	0.0kW
9	0.5	0.1	0.6	1.4kW
10	0.0	0.0	0.0	0.0kW

F4

Parameters displayed on graph

Overall display

Rate of content

Harmonic content against the 1st basic wave.
When selecting "Logarithm", 10% will be the max percentage of the vertical axis, and the higher content rates will not be displayed.

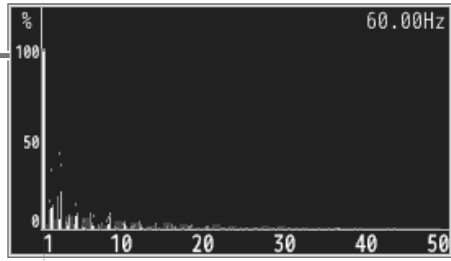

Harmonic analysis: max. 50th

Zoom

Graph color

If multiple CHs are used, colors harmonized with each CH will be used and displayed.

Max value

Max values of each order will be marked and displayed. To turn on/off this function: [SETUP]→[Measurement]→[Harmonics]→[MAX hold].

Scroll bar

White: Overall range up to 50th.

Dark orange: Current displayed area.

Use the left and right **Cursor** Keys to scroll and zoom the desirable area.

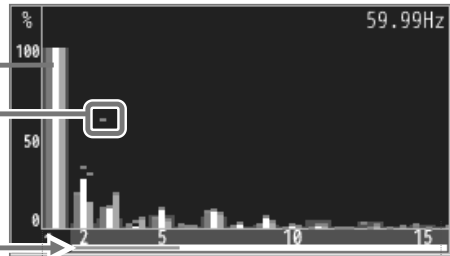

Harmonic analysis: 15/ 50th

Logarithm

Exceeding axis value

Exceeding threshold

Allowable range

Complied with IEC61000-2-4, Class3.

To change the range: [SETUP]→ [Measurement]→[Harmonics]→[Edit allowable range].

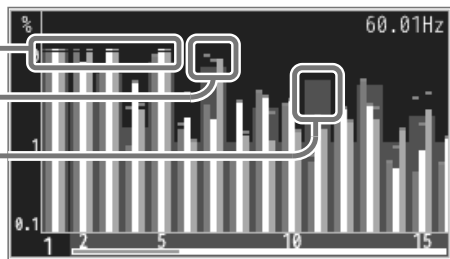

9. Power Quality

QUALITY Switching displayed items

Event

Flicker

(F1) ← → (F1)

Event

Switching measurement items

Use the up and down **Cursor** Keys and toggle the occurred events to be displayed on the screen.

(F2)

Displayed events are toggled in the following sequence.



Measurement method

Swell/ Dip/ Int/ Inrush current

Each event will be detected with the r.m.s. values in one gapless waveform and with a half-wave overlapping. The beginning of the waveform where the first event is detected is regarded as the start of the event. If further events are not detected in the following waveform, the beginning of the waveform is regarded as the end of the event. The detected event is assumed to be continued between the start to the end of event detection.

Example: Dip event detection

Int events are detected in the same method.

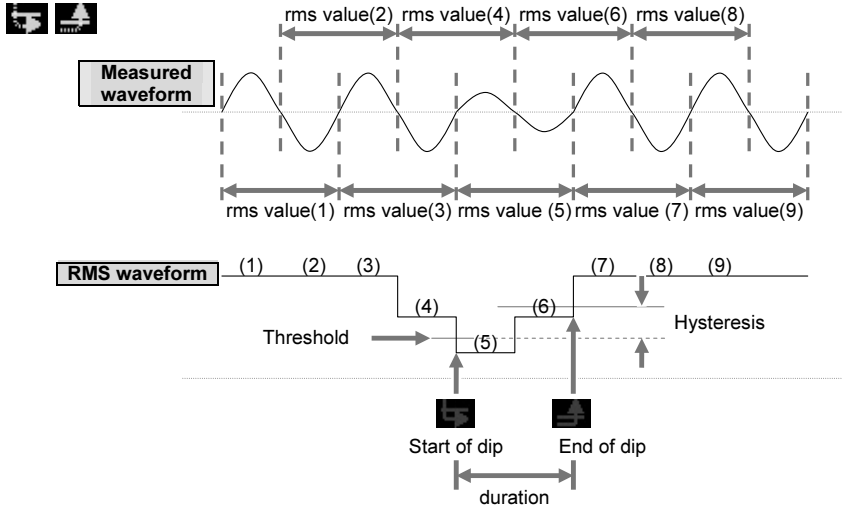

Example: Swell event detection

Inrush current events are detected in the same method.

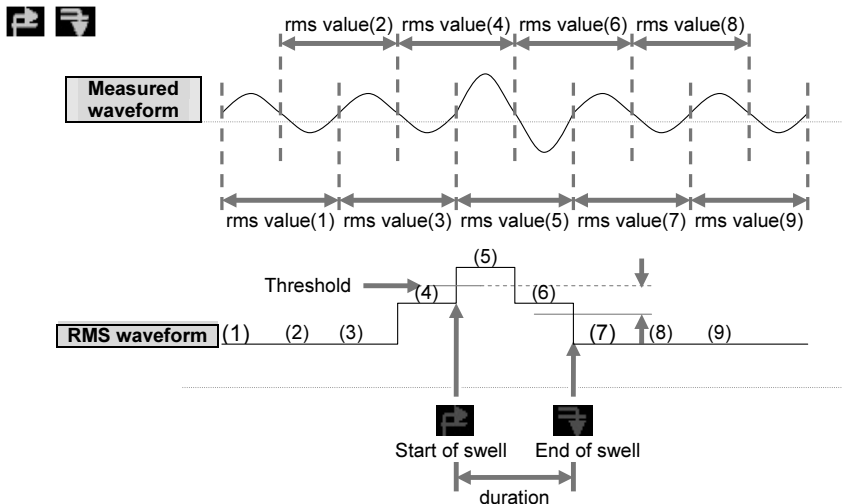

Transient

Voltage waveforms will be monitored at approx 40ksps, gapless, to calculate and check for transient event every 200ms. The beginning of the 200ms period where the first transient is detected is regarded as the start of the event. If further events are not detected in the following 200ms period, the beginning of the period is regarded as the end of the event. The detected transient is assumed to be continued between the start to the end of event detection.

Example: Transient event detection

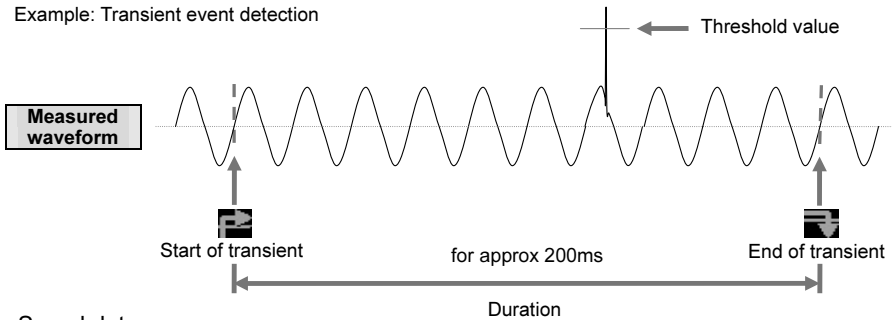

Saved data

When an event occurs and is detected, KEW6315 records the type of the event, start/ end time and the values. The following data will also be recorded. The event waveform is recorded for 200ms during the 1 sec of the data refresh period.

Event waveform

Waveforms and also event data on all the chs are recorded for approx. 200ms (50Hz: 10-cycle, 60Hz: 12-cycle) at 8192 points in total. When different events occur within 1 sec, only the waveforms which contain the highest-priority events will be recorded. However, if the same type of events occur at the same time, the one containing the highest (deepest) values will be recorded. If the highest (deepest) values are also the same, the one with a longer duration will be recorded. As for the channels, there is no priority order.

Priority order: Voltage transient-> Int-> Dip-> Swell-> Inrush current

RMS variations

Voltage/ current rms value (resolution: half-cycle) variations and event data on all chs are recorded for 1 sec at data refresh.

Example: Dip detection in 800ms period:

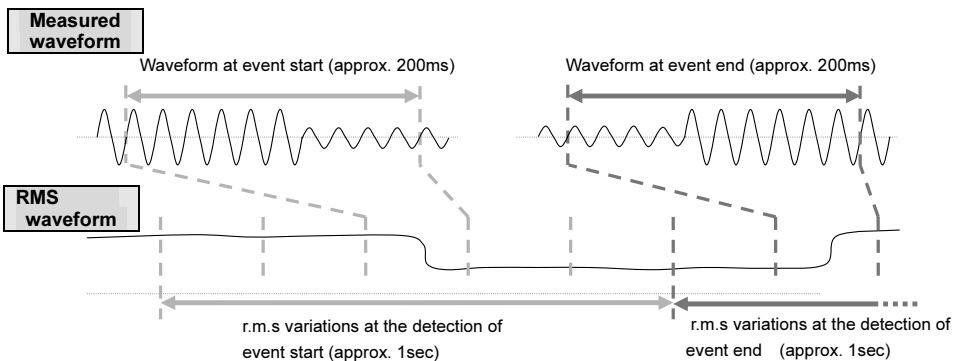

Flicker

Switching displayed items

Use the up and down **Cursor** Keys and toggle the items.

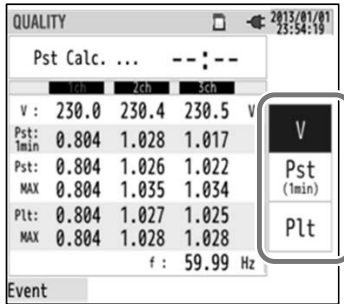

Parameters displayed when selecting “**V**” on the right panel.

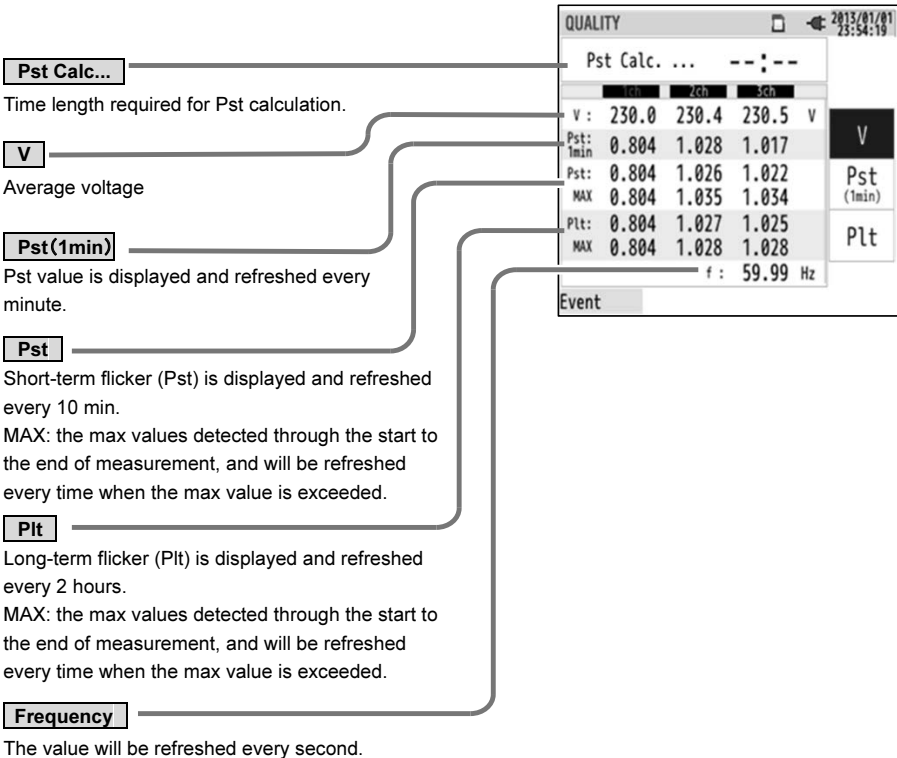

Parameters displayed when selecting “Pst(1min)” on the right row.

Pst Calc...
Time length required for Pst calculation.

Pst(1min)
Latest measured value.

Max.
Max values detected through the start to the end of measurement, and will be refreshed every time when the max value is exceeded.

Trend graph
Change of the latest 120 data Pst(1min.).

Parameters displayed when selecting “Plt” on the right row.

Plt
Plt value and the recorded date & time info where the cursor is located.

Max.
Max values detected through the start to the end of measurement, and will be refreshed every time when the max value is exceeded.

Bar graph
White bar : percentage of whole pages.
Orange bar : percentage of the present displayed pages.

Cursor
Press the right and left **Cursor** Keys to move.

Rec. start time

Latest rec. time

10. Setting

Press the **SETUP** Key to access to any of the following five settings.

Press the **Cursor** Keys to move to each setting.

- Basic setting** Make settings for the items common to each measurement.
- Meas. setting** Make settings for each measurement mode.
- Rec. setting** Make settings for recording.
- Saved data** Edit the recorded data or alter the instrument setting.
- Others** Configure the environmental setting.

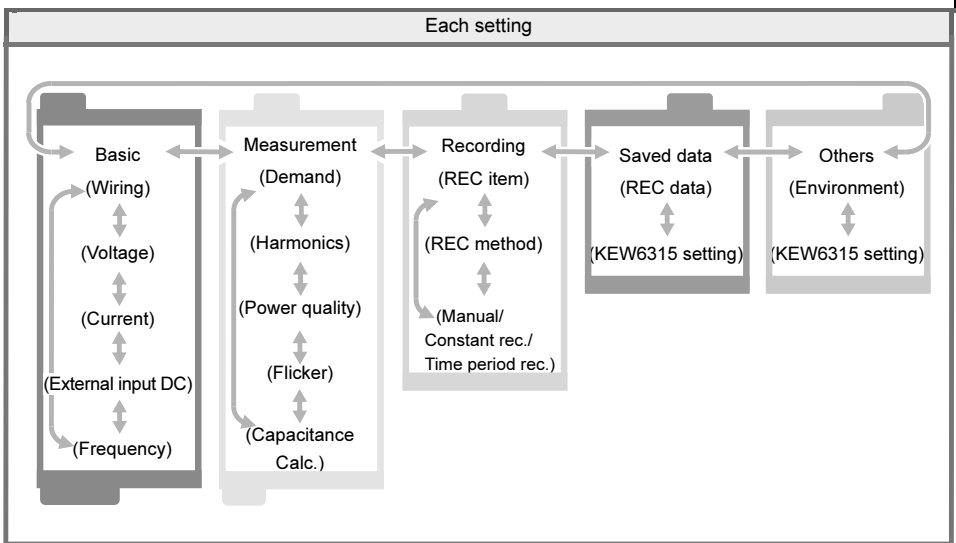

Basic setting

Setting item	Details of setting			
Wiring	①1P2W×1	⑤1P3W×1	⑦3P3W×1	
	②1P2W×2	⑥1P3W×2	⑧3P3W×2	
	③1P2W×3		⑨3P3W3A	
	④1P2W×4		⑩3P4W	
	* Current terminals that are not used in the selected wiring system can be used to measure rms currents and harmonics.			
Voltage range	600V/1000V			
VT ratio	0.01-9999.99(1.00)			
Nominal voltage	50V-600V(100V)			
Clamp/ current range	8128:5/50A/AUTO	} Power Clamp sensor		
	8135:50A/AUTO			
	8127:10/100A/AUTO			
	8126:20/200A/AUTO			
	8125:50/500A/AUTO			
	8124/8130:100/1000A/AUTO			
	8130:1000A/AUTO			
	8129:300/1000/3000A	} Leakage current Clamp sensor		
	8133:300/3000A/AUTO			
	8141: }		} 500mA/AUTO	
	8142: }			
	8143: }			
	8146: }		} 1/10A/AUTO	
	8147: }			
8148: }				
CT ratio	0.01-9999.99(1.00)			
DC range	100mV/1.000V/10V			
Frequency	50Hz/60Hz			

* Default values are highlighted in gray.

Discontinued products:8129/8141/8142/8143

Measurement setting

Setting item		Details of setting
Demand	Interval	Not be used/ 10min/15min/30min
	Inspection cycle	Interval: 10min/ 15min
		Interval: 30min
	Target	0.001mW-999.9TW(100.0kW)
Harmonics	THD(total harmonic distortion) calc.	THD-F(based on the fundamental waveform)/ THD-R(based on all rms values)
	Allowable range	Default/ customize(V/A)
	MAX HOLD	ON/OFF
Power quality	Hysteresis	against nominal V: 1 to 10%(5%)
	Transient	against nominal V: ± 50 to $\pm 2200V_{peak}$ (300%)
	Swell	against nominal V: 100 to 200%(110%)
	Dip	against nominal V: 0 to 100%(90%)
	Int	against nominal V: 0 to 100%(10%)
	InrushCurrent	against "A" range: 0 to 110%(100%)
Flicker	Filter (Ramp)	230V/220V/120V/100V
Capacitance calculation	Target PF	0.5-1(1.000)

Recording setting

Setting item		Details of setting
Recording item	Harmonics	Record/ Do not record
	Power quality (event)	Record/ Do not record
Recording method	Interval	1sec/2sec/5sec/10sec/15sec/20sec/30sec/ 1min/2min/5min/10min/15min/20min/30min/ 1hour/2hours/150,180 cycles (approx 3sec)
	Start	Manual/Constant rec./Time period rec.
Constant measurement	REC Start	Day/ Month/ Year Hour: Minute (00/00/0000 00:00)
	REC End	Day/ Month/ Year Hour: Minute (00/00/0000 00:00)
Timer	Rec. period Start-End	Day/ Month/ Year (DD/MM/YYYY)- Day/ Month/ Year (DD/MM/YYYY)
	Time period Start-End	Hour: Minute (hh:mm)- Hour: Minute (hh:mm)

* Default values are highlighted in gray.

Save setting

Setting item	Details of setting
REC data	Delete data.
	Transfer data.
	Format
KEW6315 setting	Save setting.
	Read settings.

Other settings

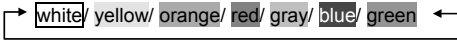
Setting item		Details of setting	
Environment	Language*	Japanese/ English	
	Date format*	YYYY/MM/DD / MM/DD/YYYY / DD/MM/YYYY	
	CH color*	 The selected color for VN is reflected on the wiring diagram only.	
KEW6315 setting	Time*	dd/mm/yyyy hh:mm:ss	
	ID Number	00-001 to 99-999(00-001)	
	Buzzer	ON/OFF	
	Bluetooth	ON/OFF	
	Power	AC power	Power off in 5 min./Disable auto-off
		Battery	Power off in 5 min.
	Backlight	AC power	Power off in 5 min./Disable auto-off
		Battery	Power off in 2 min.
	System reset	Reset the system. Confirmation message appears before resetting the system.	

Items listed with "" mark will not be restored to default even after the system is reset.

* Default values are highlighted in gray.

11. SD Card/ Saved Data

Possible recording time

When the 2GB of SD is used:

Interval	REC item		Interval	REC item	
	Power	+Harmonics		Power	+Harmonics
1sec	13days	3days	1min	1-year or more	3months
2sec	15days	3days	2min	2-year or more	6months
5sec	38days	7days	5min	6-year or more	1-year or more
10sec	2.5months	15days	10min	10-year or more	2-year or more
15sec	3.5months	23days	15min		3-year or more
20sec	5months	1month	20min		5-year or more
30sec	7.5months	1.5months	30min		7-year or more
			1hour		10-year or more
			2hours		
			150/180-cycle	23days	4days

* Data of power quality events are not considered to estimate the possible recording time.
The max possible time will be shortened by recording such events.

* Please ensure to use the SD cards provided with this instrument or as optional parts.

Saved data

The file name will be assigned automatically. File no. is kept and saved, even after powering off the instrument, until the system is reset. The file number will increase until it exceeds "999".

Print screen: Press the **PRINT SCREEN** to save the screen images as BMP files in the root directory on the SD card.

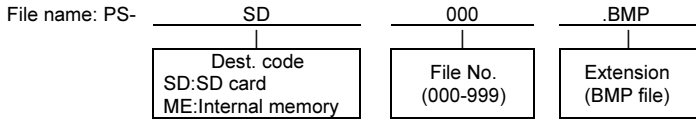

* Dest. = Destination

KEW6315 Setting: Press the **SETUP** key and move to "Saved data" tab, and then select "Save Settings".

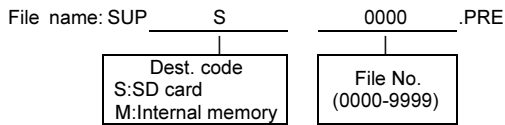

Data folder: New folder will be created per measurement to save the interval and power quality data.

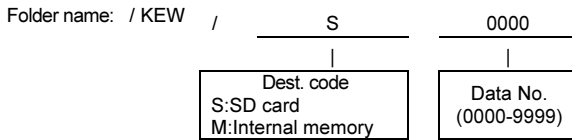

Interval data

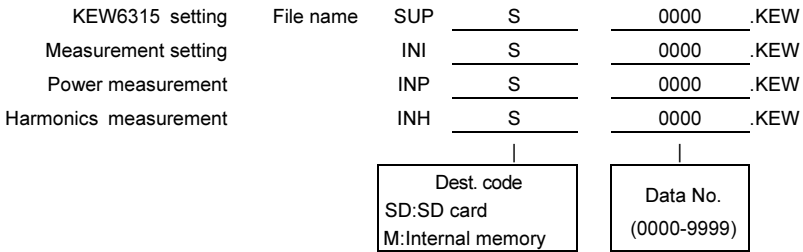

Power quality data

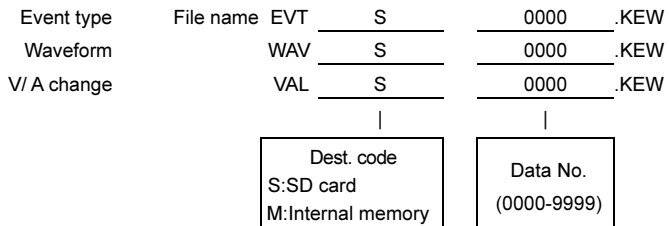

Saved items

The following data measured on each CH will be saved according to the selected recording method.
Saved items are depending on the selected recording method and wiring system.

REC file	REC item	Meas./ Rec. setting		
		Power	+Harmonics	+Event
Power measurement	RMS voltage (line/ phase)			
	RMS current			
	Active power			
	Reactive power			
	Apparent power			
	Power factor			
	Frequency			
	Neutral current(3P4W)			
	V/ A phase angle (1st order)			
	Analog input voltage, 1CH, 2CH			
	V/A unbalance ratio			
	1-min Voltage flicker	●	●	●
	Short-term V Flicker (Pst)			
	Long-term V Flicker (Plt)			
	Capacitance calculation			
	Active power energy (consumption/ regenerating)			
	Reactive power energy (consumption) lagging/ leading			
	Apparent power energy (consumption/ regenerating)			
	Reactive power energy (regenerating) lagging/ leading			
	Demand (W/VA)			
Target demand (W/VA)				
Total harmonic distortion of V(F/R)				
Total harmonic distortion of A(F/R)				
Harmonics measurement	Harmonic V/ A(1-50th order)			
	V/ A phase angle (1-50th order)		●	
	V/ A phase difference (1-50th order)			
	Harmonic power(1-50th order)			
V/ A Change	RMS voltage per half-cycle			
	RMS current per half-cycle			●
Event type	Event detected date&time			
	Event type			●
	Measured values at event detection			
Waveform	V/A waveform			●

Data transfer

1. SD card and USB

Data in the SD card or the internal memory can be transferred to PC using USB connection or SD card slot/ reader.

	Method of transfer	
	USB	Card reader
SD card data (file)	△ ^{*1}	○
Internal memory data (file)	○	-----

*1: It is recommended to transfer the large data by use of SD card since transferring large data files by USB requires more time than using the SD card reader. (transfer time : approx 320MB/ hour)
As to the manipulation of SD cards, please refer to the instruction manual attached to the card.
In order to save data without any problem, make sure to delete the files other than the data measured with this instrument from the SD card beforehand.

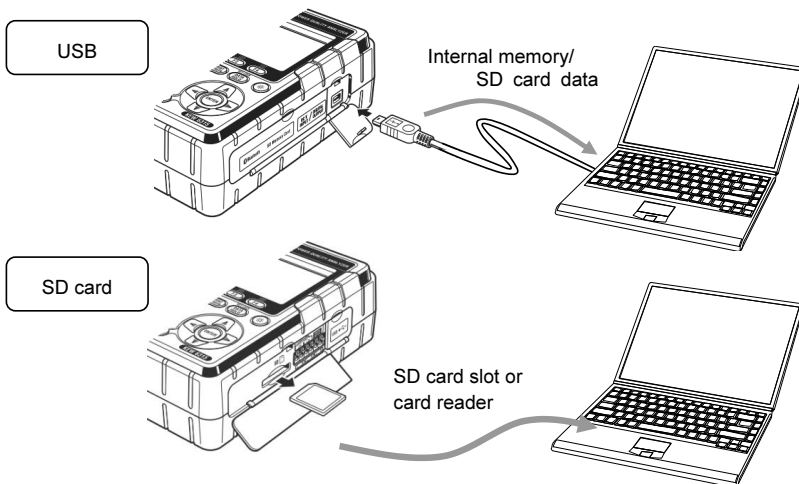

2. Bluetooth

Measuring data can be checked on android devices in real-time via Bluetooth communication. It is necessary to enable Bluetooth function prior to using Bluetooth communication. (Setting No. 26: Bluetooth)

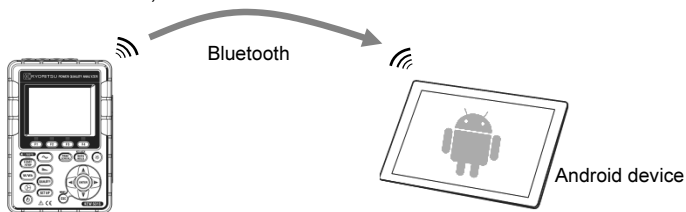

Before starting to use this function, download the special application "KEW Smart" from the Internet site. The application "KEW Smart" is available on the download site for free. (Internet access is required and charges may be incurred.)

MEMO

DISTRIBUTOR

Kyoritsu reserves the rights to change specifications or designs described in this manual without notice and without obligations.



KYORITSU ELECTRICAL INSTRUMENTS WORKS, LTD.

2-5-20, Nakane, Meguro-ku,
Tokyo, 152-0031 Japan
Phone: +81-3-3723-0131
Fax: +81-3-3723-0152
URL: www.kew-ltd.co.jp
Factory: Ehime, Japan