

Trunking

Trunking made of roll-formed sheet steel in white polyester lacquer finish. 5 mains power lines (5 x 2.5mm²/16A) plus 2 x 2 conductors (4 x 1.5mm²/10A) for integrating emergency lighting using two independently isolated circuits, plus and 2 control-line conductors (2 x 1.5mm²/10A). Tool-free connection using electrical feed kit. Dimensions: 3000 x 60 x 54 mm; weight: 5.3 kg

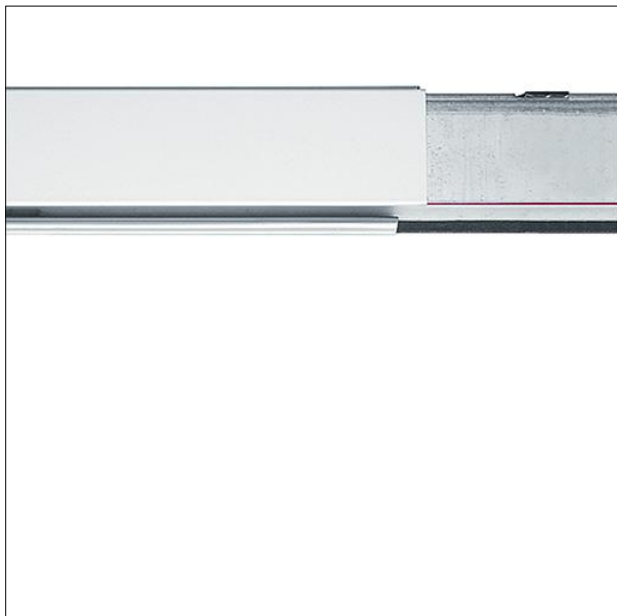

ZS_TEC_F_Trageschiene.jpg

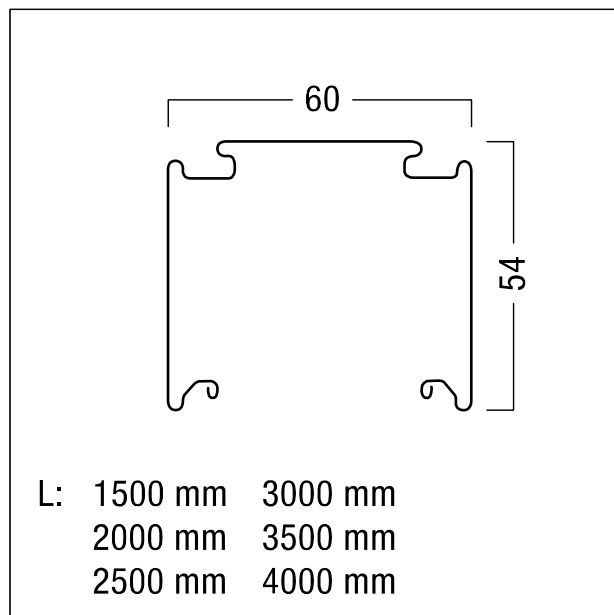

ZS_TEC_M_Tragschienen.wmf