









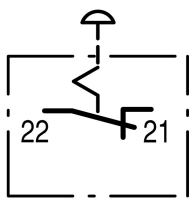
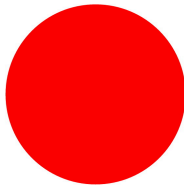
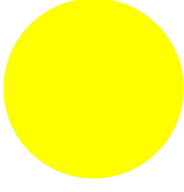
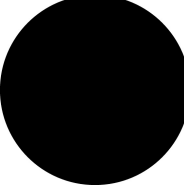

Palm switch, 1 N/C, emergency switching off, surface mounting

Part no. FAK-R/V/KC01/IY
Catalog No. 229747
Alternate Catalog No. FAK-R-V-KC01-IY
EL-Nummer (Norway) 4355791

Delivery program

| | | |
|---------------------------|--|--|
| Product range | | Foot and palm switches |
| Basic function | | Complete devices |
| Single unit/Complete unit | | Complete unit |
| Function | | maintained |
| Description | | Pull to release Emergency stop pushbutton tamper-proof to ISO 13850/EN 418 |
| Contacts | | |
| N/C = Normally closed | | 1 NC  |
| Notes | |  = safety function, by positive opening to IEC/EN 60947-5-1 |
| Contact sequence | |  |
| Colour | | |
| Button | | Red  |
| enclosure top | | Yellow  |
| Enclosure base | | Black  |

| | | | |
|----------------------------|--|--|--|
| Approval | | |      |
| Connection to SmartWire-DT | | | no |

Technical data

General

| | | | |
|------------------------------------|--------------|-------------------|--|
| Standards | | | IEC/EN 60947-5-5, VDE 0660 |
| Lifespan, mechanical | Operations | x 10 ⁶ | > 0.1 |
| Operating frequency | Operations/h | | ≤ 600 |
| Actuating force | | N | 40 - 60 |
| Degree of protection, IEC/EN 60529 | | | IP66, IP67, IP69 |
| Climatic proofing | | | Damp heat, constant, to IEC 60068-2-78 Damp heat, cyclic, to IEC 60068-2-30 |
| Ambient temperature | | | |
| Open | | °C | -25 - +55 |
| Mounting position | | | As required |
| Mechanical shock resistance | | g | > 15 Shock duration 11 ms Sinusoidal according to IEC 60068-2-27 |

Design verification as per IEC/EN 61439

| | | | |
|--|-------------------|----|--|
| Technical data for design verification | | | |
| Rated operational current for specified heat dissipation | I _n | A | 6 |
| Heat dissipation per pole, current-dependent | P _{vid} | W | 0.11 |
| Equipment heat dissipation, current-dependent | P _{vid} | W | 0 |
| Static heat dissipation, non-current-dependent | P _{vs} | W | 0 |
| Heat dissipation capacity | P _{diss} | W | 0 |
| Operating ambient temperature min. | | °C | -25 |
| Operating ambient temperature max. | | °C | 55 |
| IEC/EN 61439 design verification | | | |
| 10.2 Strength of materials and parts | | | |
| 10.2.2 Corrosion resistance | | | Meets the product standard's requirements. |
| 10.2.3.1 Verification of thermal stability of enclosures | | | Meets the product standard's requirements. |
| 10.2.3.2 Verification of resistance of insulating materials to normal heat | | | Meets the product standard's requirements. |
| 10.2.3.3 Verification of resistance of insulating materials to abnormal heat and fire due to internal electric effects | | | Meets the product standard's requirements. |
| 10.2.4 Resistance to ultra-violet (UV) radiation | | | Please enquire |
| 10.2.5 Lifting | | | Does not apply, since the entire switchgear needs to be evaluated. |
| 10.2.6 Mechanical impact | | | Does not apply, since the entire switchgear needs to be evaluated. |
| 10.2.7 Inscriptions | | | Meets the product standard's requirements. |
| 10.3 Degree of protection of ASSEMBLIES | | | Does not apply, since the entire switchgear needs to be evaluated. |
| 10.4 Clearances and creepage distances | | | Meets the product standard's requirements. |
| 10.5 Protection against electric shock | | | Does not apply, since the entire switchgear needs to be evaluated. |
| 10.6 Incorporation of switching devices and components | | | Does not apply, since the entire switchgear needs to be evaluated. |
| 10.7 Internal electrical circuits and connections | | | Is the panel builder's responsibility. |

| | | |
|--|--|--|
| 10.8 Connections for external conductors | | Is the panel builder's responsibility. |
| 10.9 Insulation properties | | |
| 10.9.2 Power-frequency electric strength | | Is the panel builder's responsibility. |
| 10.9.3 Impulse withstand voltage | | Is the panel builder's responsibility. |
| 10.9.4 Testing of enclosures made of insulating material | | Is the panel builder's responsibility. |
| 10.10 Temperature rise | | The panel builder is responsible for the temperature rise calculation. Eaton will provide heat dissipation data for the devices. |
| 10.11 Short-circuit rating | | Is the panel builder's responsibility. The specifications for the switchgear must be observed. |
| 10.12 Electromagnetic compatibility | | Is the panel builder's responsibility. The specifications for the switchgear must be observed. |
| 10.13 Mechanical function | | The device meets the requirements, provided the information in the instruction leaflet (IL) is observed. |

Technical data ETIM 7.0

| | | |
|---|----|--------------|
| Low-voltage industrial components (EG000017) / Foot-/palm switch complete (EC000231) | | |
| Electric engineering, automation, process control engineering / Low-voltage switch technology / Command and alarm device / Foot, palm switch (ecl@ss10.0.1-27-37-12-17 [AKF035014]) | | |
| Unlocking method | | Pull-release |
| Colour cap | | Red |
| Number of contacts as normally open contact | | 0 |
| Number of contacts as normally closed contact | | 1 |
| Switching function latching | | Yes |
| Spring-return | | No |
| Hole diameter | mm | 0 |
| Degree of protection (IP) | | IP67/IP69K |
| Degree of protection (NEMA) | | 4X |

Approvals

| | | |
|-----------------------------|--|--|
| Product Standards | | IEC/EN 60947-5; UL 508; CSA-C22.2 No. 14-05; CSA-C22.2 No. 94-91; CE marking |
| UL File No. | | E29184 |
| UL Category Control No. | | NKCR |
| CSA File No. | | 012528 |
| CSA Class No. | | 3211-03 |
| North America Certification | | UL listed, CSA certified |
| Degree of Protection | | UL/CSA Type 3R, 4X, 12, 13 |

Dimensions

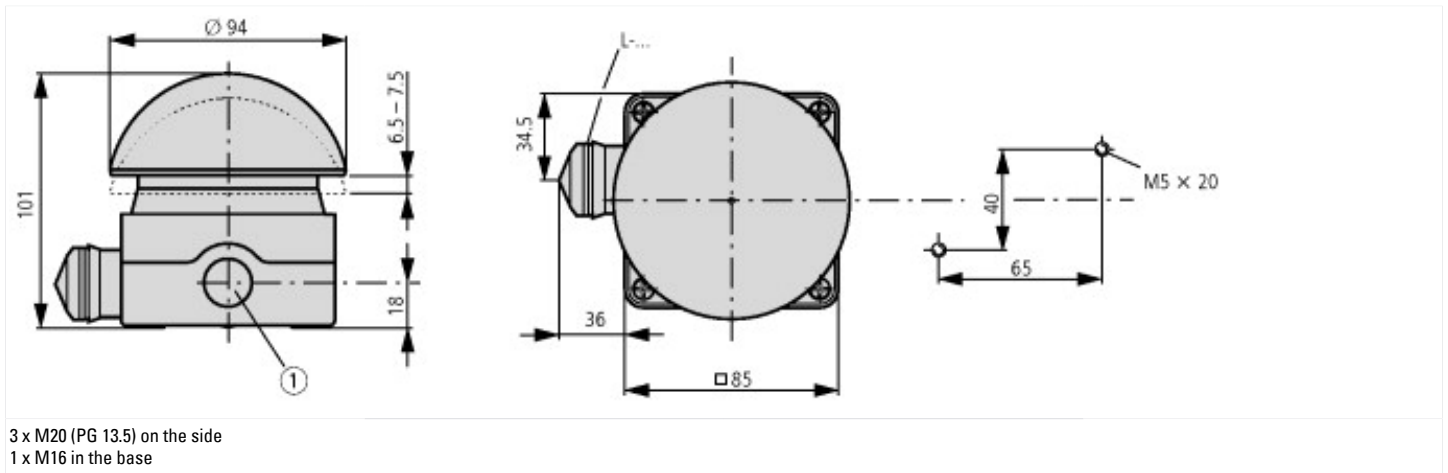

Additional product information (links)

| | |
|--|---|
| IL04716017Z (AWA1160-1467) Foot and palm switches | |
| IL04716017Z (AWA1160-1467) Foot and palm switches | ftp://ftp.moeller.net/DOCUMENTATION/AWA_INSTRUCTIONS/IL04716017Z2018_05.pdf |